

 **vallés**
CONSTRUCCIÓN

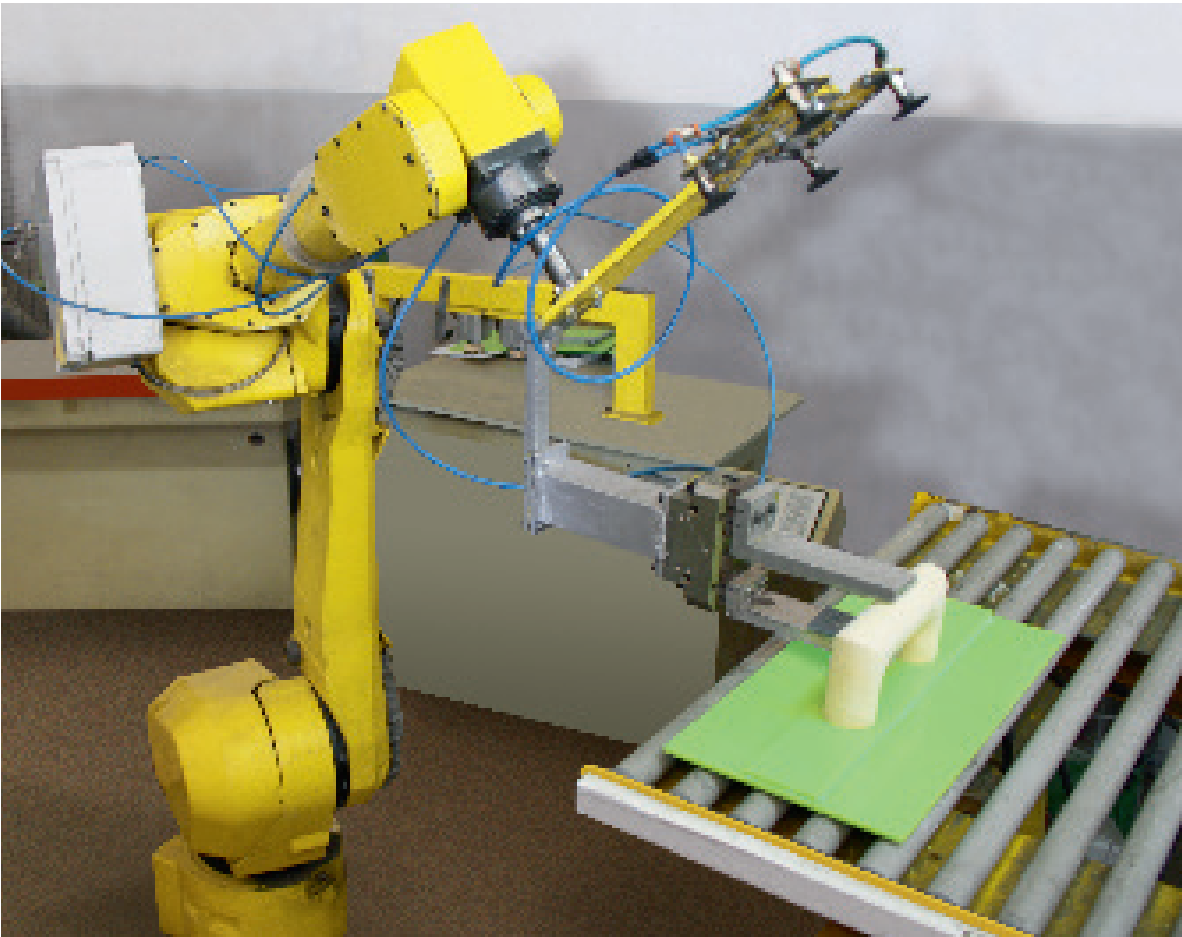

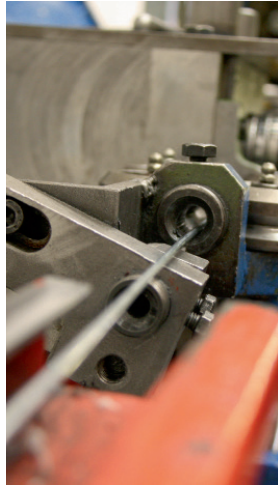

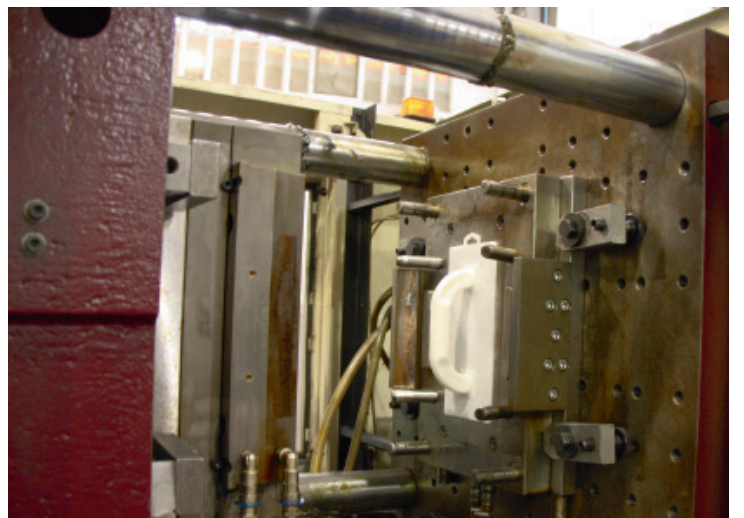
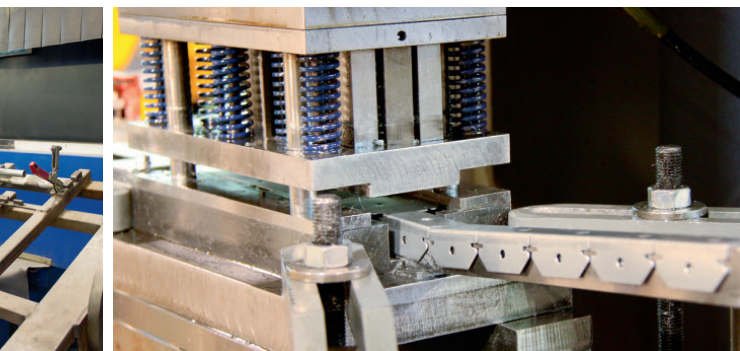
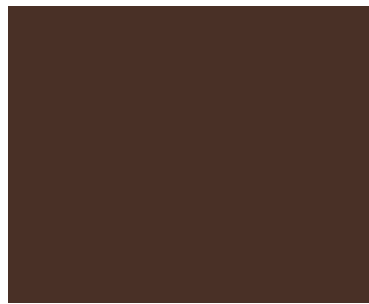
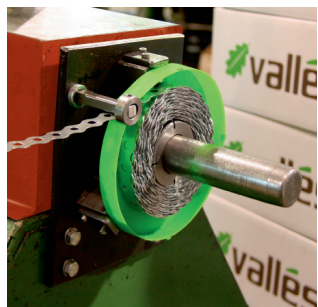

Paletas y paletines 6 - 8

- 6 paleta de sacar
- 6 paletines soldados
- 6 paletines forjados
- 7-8 paletas soldadas
- 7-8 paletas forjadas
- 8 paletines inox



Llanas dentadas 9 - 11

- 9 llanas dentadas inoxidable mango normal
- 10 llanas dentadas acero al carbono mango normal
- 11 llanas dentadas inoxidable

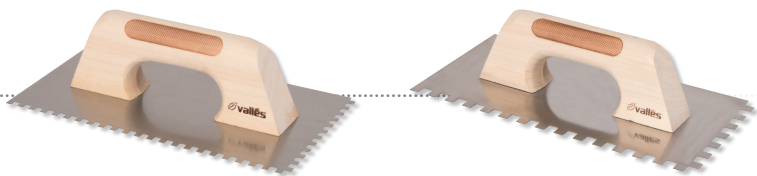

Llanas inox y llanas plástico 12

- 12 llanas inoxidable dientes
- 12 llanas plástico blanco microcemento
- 12 hoja de plástico blanco

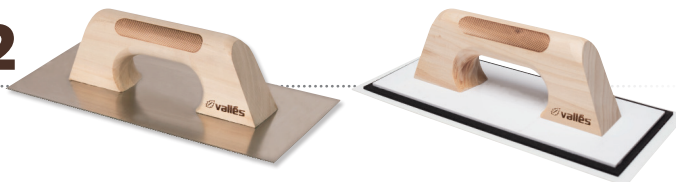

Llanas y talochas de plástico 13

- 13 talochas de plástico
- 13 llanas de plástico
- 13 lana de poliestireno sistema SATE
- 13 lana de plástico ABS

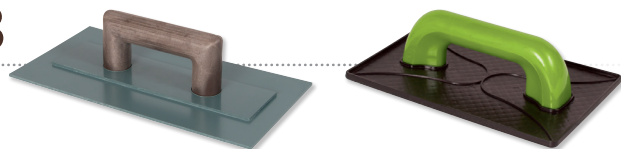

Alisadores 14-15

- 14 alisadores
- 14 alisadores techo
- 15 mangos aluminio
- 15 recambios alisadores

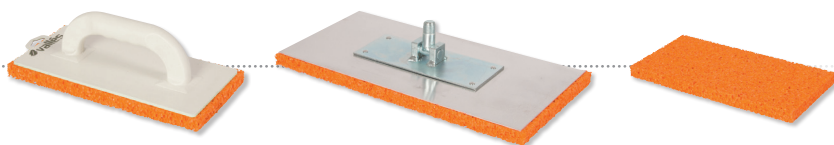

Limpieza y herramientas rejuntar 16

- 16 cubo de limpieza
- 16 ventosas de manipulación
- 16 esponjas
- 16 rodilleras

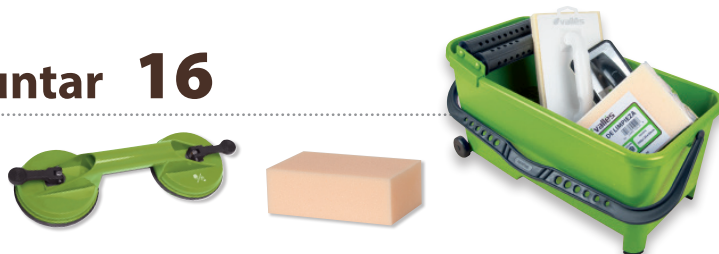

Talochas limpieza y llanas rejuntar 17

- 17 talochas esponja limpieza
- 17 llanas juntas
- 17 llanas para rejuntar



Remolinadores 18

- 18 remolinadores poliestireno
- 18 remolinadores espuma



Rascadores 19

- 19 rascador rejilla
- 19 rascador monocapa
- 19 recambio rascador monocapa
- 19 rascador planchas XPS (SATE)

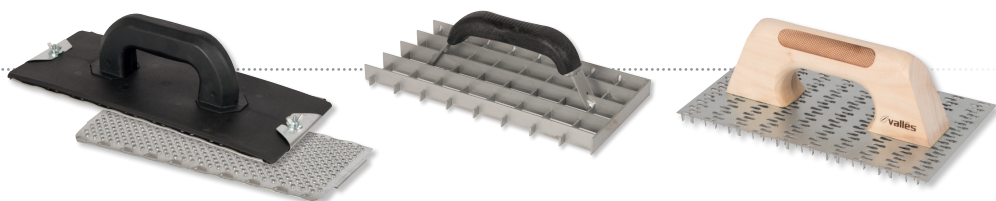

Cepillos dentados, cortafrios, tornillo apriete, lijadora, maza 20



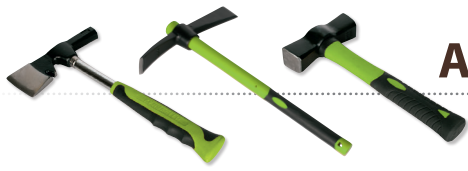

Alcotanas, piquetas, maceta y hacha 21



Niveles 22



niveles de aluminio	22
Tubo pvc transparente nivel agua	22
nivelador suelo	22



Legones y raederas 23

legón mango de madera o hierro	23
legón media luna	23
mango madera repuesto	23
raedera media luna mango aluminio	23
raeder media luna sin mango	23

Repartidores de cemento, rasqueta y rascadores 24



repartidores de cemento mango aluminio o hierro	24
rasqueta de acero galvanizado mango de madera	24
rascadores de suelo	24



Palas 25



Pasteras 26



Borriquetes y banqueta 27

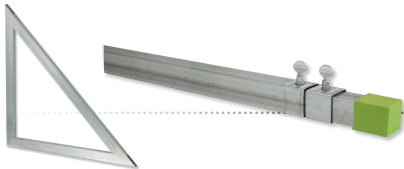

Regles y escuadra 28



Junquillos y guardavivos 29



Capazos y cubos 30-31

Accesorios 32 - 34



32	Tiralíneas
32	Polvo para trazar
32	Flejes de obra
32	Garra
32	Tapón poste vallas
32	Cantонера
33	Pistola de silicona
33	Tenazas
34	Casco
34	Cinturón
34	Calentador
34	Flexómetros



Paleta de sacar

Trowel of derive
Truelle d'extraire

ref	mm	box
870015	200x120x1,5	1/6



**Paletín forjado
punta redonda**

Bricklaying round tip forged trowel
Truelle forgé bout rond

ref	mm	box
870GS1	130x70	1/6



**Paletín soldado
punta redonda**

Welded bricklaying round tip trowel
Truelle soudée bout rond

ref	mm	box
870001	130x70	1/12/72



**Paletín forjado
punta aguda**

Bricklaying sharp point forged trowel
Truelle forgé bout pointe acérée

ref	mm	box
870GS4	128x67	1/6



**Paletín soldado
punta aguda**

Welded bricklaying sharp point trowel
Truelle soudée bout pointe acérée

ref	mm	box
870004	128x67	1/12/72



**Paleta forjada
modelo Catalana**

Bricklaying Catalana model
forged trowel
Truelle forgé modèle Catalana

ref	mm	box
870GS3	170x120	1/6



**Paleta soldada
modelo Catalana**

Welded bricklaying
Catalana Model Trowel
Truelle soudée modèle Catalana

ref	mm	box
870003	170x120	1/12/72



**Paleta forjada
modelo Madrid**

Bricklaying Madrid
model forged trowel
Truelle forgé modèle Madrid

ref	mm	box
870GS2	180x100	1/6



**Paleta soldada
modelo Madrid**

Welded bricklaying
Madrid model trowel
Truelle soudée modèle Madrid

ref	mm	box
870002	180x100	1/12/72



**Paleta forjada
modelo Norte**

Bricklaying Norte model
forged trowel
Truelle forgé modèle Norte

ref	mm	box
870GS5	180x115x87	1/6



**Paleta soldada
modelo Norte**

Welded bricklaying
Norte model trowel
Truelle soudée modèle Norte

ref	mm	box
870005	180x115x87	1/12/72



**Paleta forjada
modelo Solador**

Solador model forged trowel
Truelle forgé modèle Solador

ref	mm	box
870GS6	120x110x75	1/6



**Paleta soldada
modelo Solador**

Welded bricklaying
Solador model trowel
Truelle soudée modèle Solador

ref	mm	box
870006	120x110x75	1/12/72



**Paleta soldada
modelo Sevilla**

Welded bricklaying
Sevilla model trowel
Truelle soudée modèle Sevilla

ref	mm	box
870007	190x100x90	1/12/72

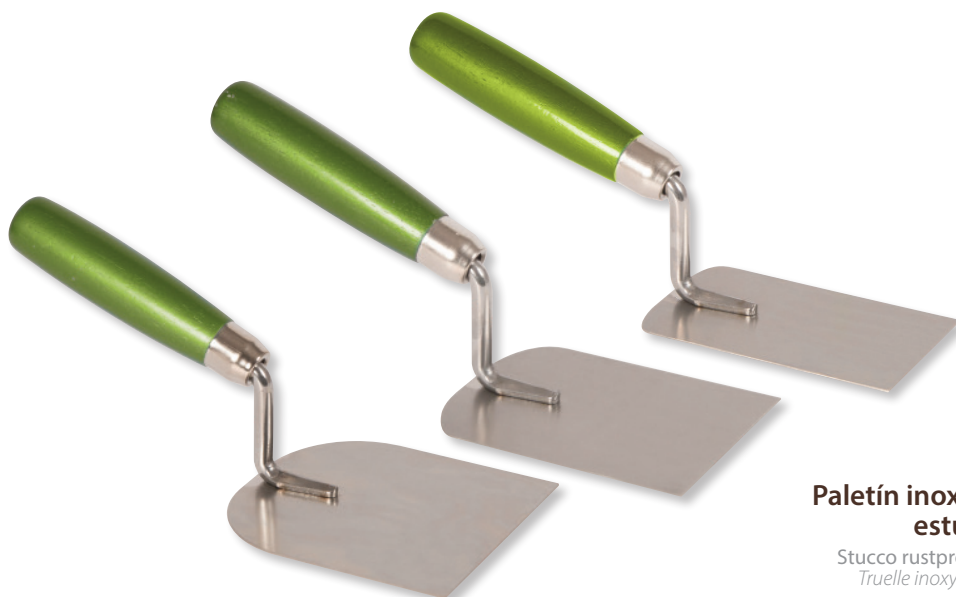

**Paletín inoxidable
estucador**

Stucco rustproff trowel
Truelle inoxydable stuc

ref	mm	box
870016	60	1/12
870017	80	1/12
870009	100	1/12/48

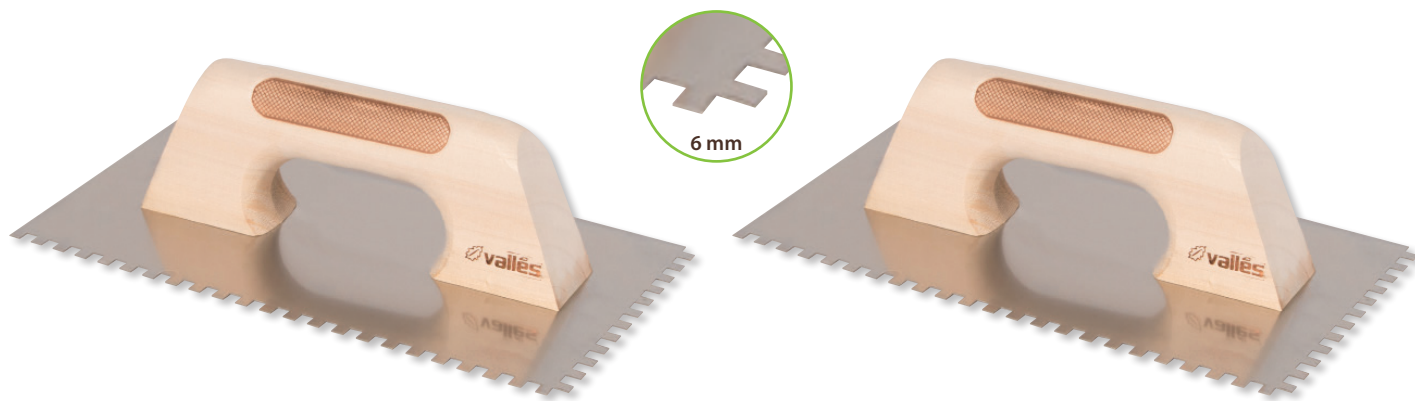

Llana inox D6 con tornillos

Stainless steel D6 with screws
Acier inoxydable D6 avec vis

ref	mm	box
66TD19	280x150	1/12/BP



Llana inox D6 con soldada

Stainless steel D6 welded
Acier inoxydable D6 soudée

ref	mm	box
663D19	280x150	1/12/BP

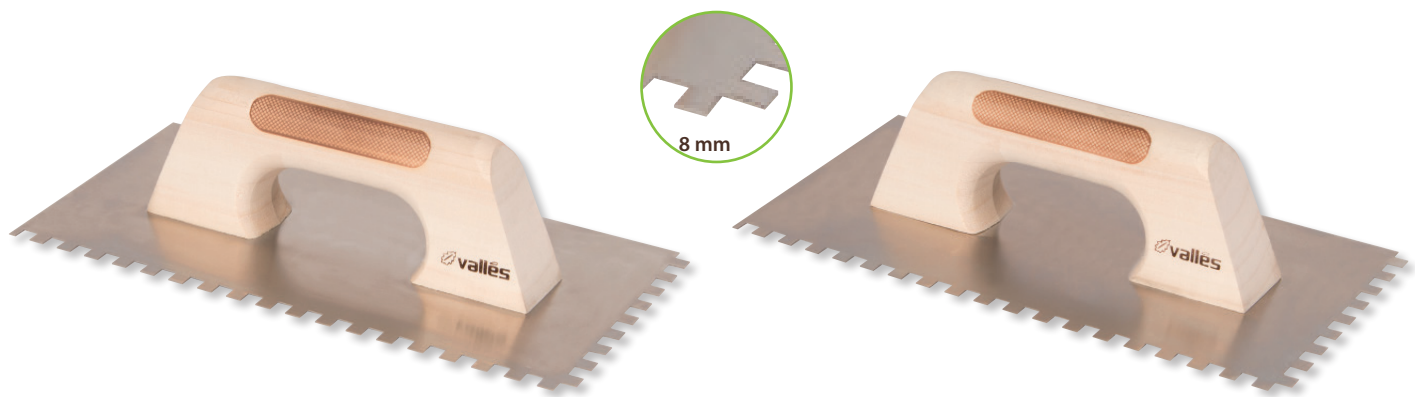

Llana inox D8 con tornillos

Stainless steel D8 with screws
Acier inoxydable D8 avec vis

ref	mm	box
66TD28	300x150	1/12



Llana inox D8 con soldada

Stainless steel D8 welded
Acier inoxydable D8 soudée

ref	mm	box
663D28	300x150	1/12/BP

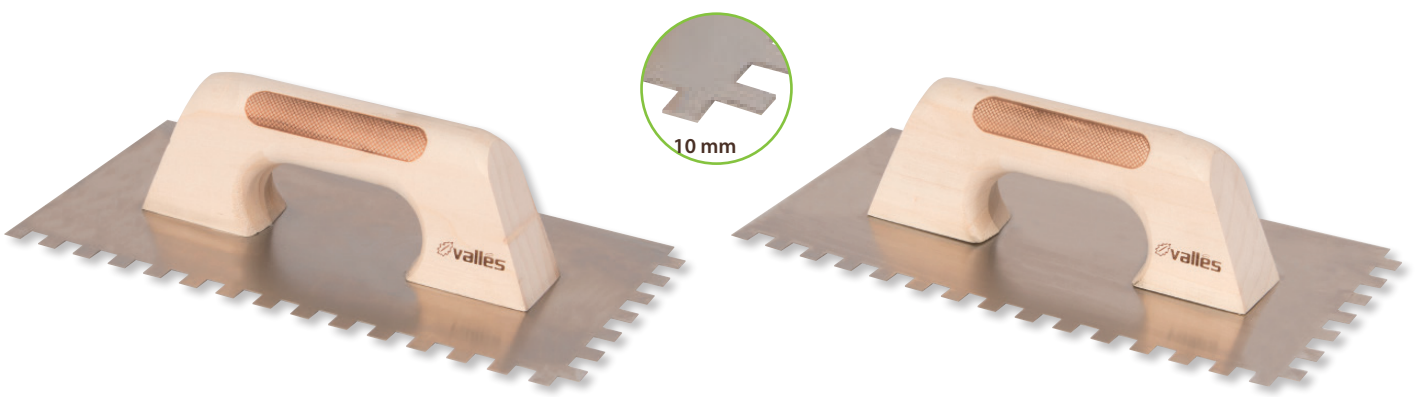

Llana inox D10 con tornillos

Stainless steel D10 with screws
Acier inoxydable D10 avec vis

ref	mm	box
663D24	300x150	1/12



Llana inox D10 con soldada

Stainless steel D10 welded
Acier inoxydable D10 soudée

ref	mm	box
663D20	300x150	1/12/BP



Ilanas dentadas acero al carbono mango normal

10 Carbon Steel trowel teeth / Truelle acier de carbone dents

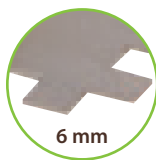

Llana D6 con tornillos

D6 trowel with screws
D6 truelle à vis

ref	mm	box
66TD09	280x150	1/12/BP



Llana D6 soldada

Plain D6 welded
Plaine D6 soudée

ref	mm	box
663D09	280x150	1/12/BP

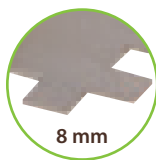

Llana D8 con tornillos

D8 trowel with screws
D8 truelle à vis

ref	mm	box
66TD30	300x150	1/12/BP



Llana D8 soldada

Plain D8 welded
Plaine D8 soudée

ref	mm	box
663D30	300x150	1/12/BP

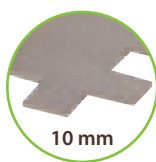

Llana D10 con tornillos

D10 trowel with screws
D10 truelle à vis

ref	mm	box
663D26	300x150	1/12/BP



Llana D10 soldada

Plain D10 welded
Plaine D10 soudée

ref	mm	box
663D22	300x150	1/12/BP



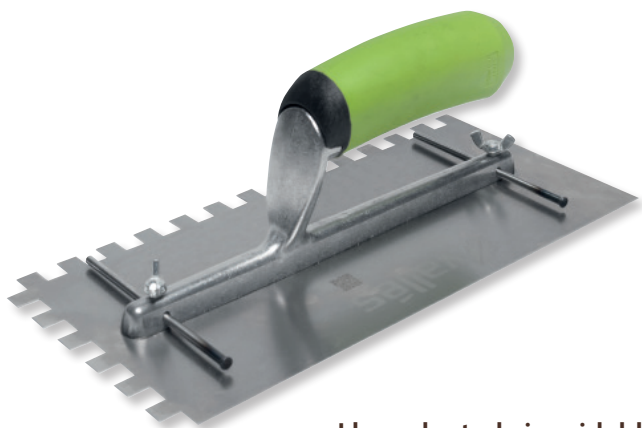

Llana dentada inoxidable soldada D10 punzones niveladores mango americano goma especial

D10 welded stainless steel trowel levelers
American handle special rubber.
*Niveleurs de truelle en acier inoxydable soudé D10
Poignée américaine en caoutchouc spécial*

ref	mm	box
663IAGD10NVL	280x130	1/12/BP

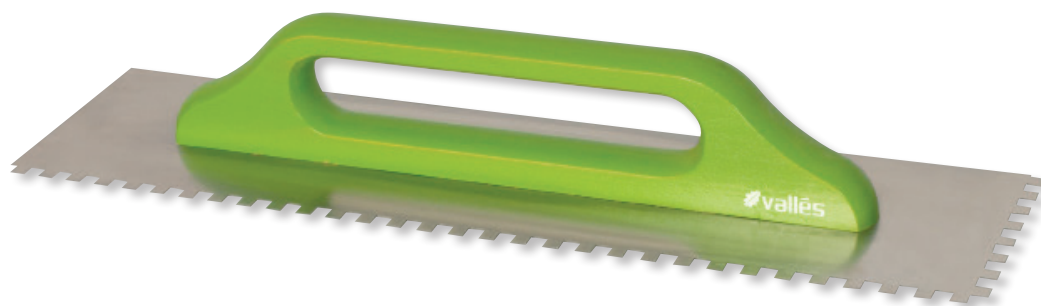

Llana dentada inoxidable D8 mango largo con tornillos

Rustproof trowel long handle teeth 8 mm. with screws
Truelle inoxydable dents 8 mm. mangue long avec vis

ref	mm	box
663I8R	500x130	1/6/BP



Llana dentada inoxidable D10 mango largo con tornillos

Rustproof trowel long handle teeth 10 mm. with screws
Truelle inoxydable dents 10 mm. mangue long avec vis

ref	mm	box
66TRDI	500x130	1/6/BP



12 llanas inox diente de sierra y llanas microcemento

12 plastering trowels and microcement flat / platoirs et microciment plat



Llana inoxidable soldada mango normal dientes sierra finos

Welded rustproof trowel thin teeth
Truelle inoxydable soudée dents fin



ref	mm	box
663SI5	300x150	1/12/BP



Llana inoxidable soldada mango redondo dientes sierra finos

Welded rustproof trowel thin teeth
Truelle inoxydable soudée dents fin



ref	mm	box
663SIRF	300x150	1/12/BP



Llana plástico blanco microcemento mango normal

Plastic trowel white for microcement normal handle
Taloche flexible pour béton ciré poignée standart



ref	mm	box
663PM0	300x150	1/12/BP



Llana plástico blanco microcemento mango redondo

Plastic trowel white for microcement rounded handle
Taloche flexible pour béton ciré poignée arrondie



ref	mm	box
663PMR	300x150	1/10/BP



Hoja plástico blanco microcemento

Plastic sheet white microcement
Rechange plastique blanc pour béton ciré

ref	mm	box
663PHM	295x135	1/5/BP



Talocha plástico gris mango plástico

Grey plastic float plastic handle
Taloche du plastique gris manche plastique

ref	mm	box
662QP1	280x160	1/25/BP
662QP2	360x190	1/18
662QP3	520x210	1/20



Llana plástico punta mango normal plástico

Plastic tip trowel plastic handle
Truelle du plastique avec pointe manche plastique

ref	mm	box
662TPP	265x140	1/12/48



Talocha plástico mango normal plástico

Plastic trowel plastic handle
Truelle du plastique manche plastique

ref	mm	box
662TP0	270x180	1/12/48

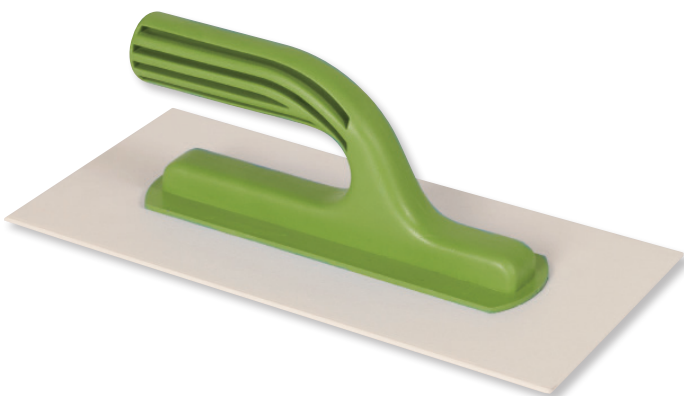

Llana de poliestireno para sistema SATE

Polystyrene trowel
Truelle du polystyrène

ref	mm	box
662TPB	280x140	1/30



Llana de plástico ABS mango americano para sistemas SATE

ABS plastic trowel american handle
ABS Truelle du plastique manche américain

ref	mm	box
662TPA	300x140	1/8



Alisador esponja basta

Sponge smoother rough
Lisseur éponge grosse

ref	mm	box
560201	240x120	1/12
560502	280x140	1/10



Alisador esponja intermedia

Sponge smoother intermediate
Lisseur éponge intermédiaire

ref	mm	box
560507	280x140	1/10



Alisador esponja basta amarilla

Sponge smoother yellow rough
Lisseur éponge grosse jaune

ref	mm	box
560509	280x140	1/10/360



Alisador esponja fina

Sponge smoother fine
Lisseur éponge fine

ref	mm	box
566503	280x140	1/10/360

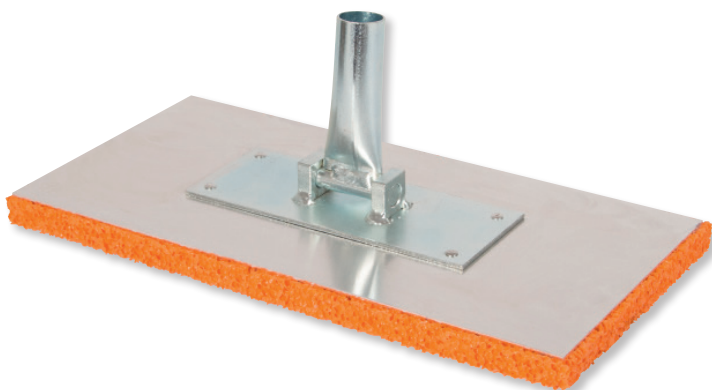

Alisador esponja techo para mango embutido

Roof smoother without handle
sponge inlay
Lisseur pour plafond éponge saucisse

ref	mm	box
566557	400x200	1/6

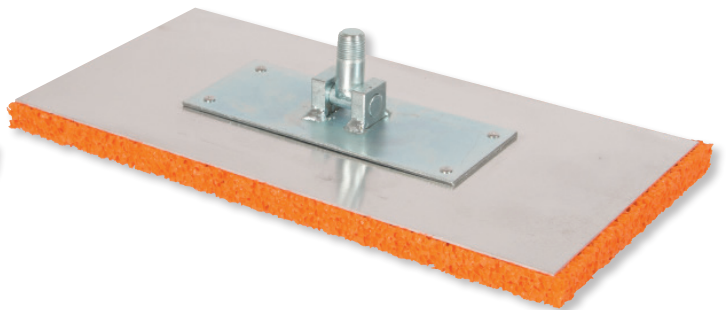

Alisador esponja techo para mango rosca

Roof smoother
Lisseur pour plafond

ref	mm	box
566575	400x200	1/6

Mango aluminio embutido 1800

Inlay aluminum handle 1800
Manche en aluminium avec 1800
incrustations

ref	mm	box
663M19	27,5Ø x 1800	1

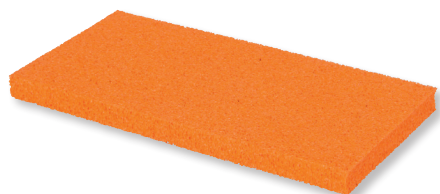
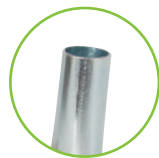

Recambio esponja intermedia

Sponge spare part intermediate
Rechange d'éponge intermédiaire

ref	mm	box
560508	280x140	1/15/70



Mango aluminio rosca 1300

Thread aluminum handle 1300
Poignée en aluminium avec filetage 1300

ref	mm	box
663M06	27,5Ø x 1300	1



Recambio esponja fina

Sponge spare part fine
Rechange d'éponge fine

ref	mm	box
566506	280x140	1/15/70



Recambio esponja basta

Sponge spare part rough
Rechange d'éponge grosse

ref	mm	box
560506	280x140	1/15/70



Recambio esponja basta amarilla 30 mm

Sponge refill enough yellow
Recharge éponge assez de jaune

ref	mm	box
560510	280x140	1/15/70



Recambio grande esponja basta

Great sponge spare part rough
Grand rechange d'éponge grosse

ref	mm	box
566508	400x200	1/18/35

Recambio de esponja

Sponge spare part
Rechange d'éponge

ref	mm	box
56R001	Ø390x16	1



Cubo limpieza alisadores

Straightening cleaning pails
Sceau de nettoyage

ref	mm	box
701048	Ø115	1

Kit cubo limpieza alisadores cubo + talocha + esponja + llana

Straightening cleaning pails
Sceau de nettoyage

ref	mm	box
701051	Ø115	1

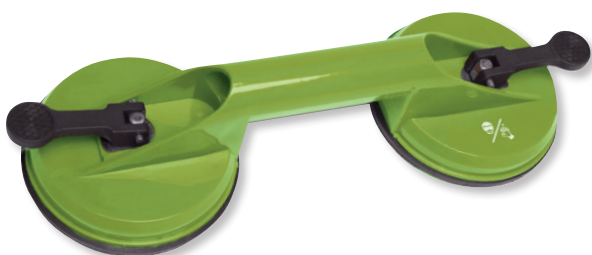

Ventosa doble manipulación baldosas, azulejo, vidrio

Double suction pad for floor tile, marble, glass
Double ventouse de manipulation pour carreau, marbre, verre

ref	mm	box
853006	350	1/12/48



Ventosa manipulación baldosas, azulejo, vidrio

Suction pad for floor tile, glazed tile, glass
Ventouse du manipulation pour tuile, carreau, verre

ref	mm	box
853001	Ø115	1/12/48

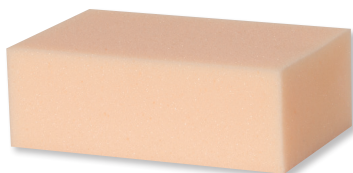

Esponja de limpieza

Cleaning sponge
Éponge pour nettoyage

ref	mm	box
561501	200x125x70	1/12/144



Esponja de limpieza doble cara

Double-sided cleaning sponge
Éponge de nettoyage double face

ref	mm	box
561502	170x100x65	1/12/144



Rodilleras (2 uds.)

Rubber knee pads
Genouillères en gomme

ref	mm	box
853002	150x140	1/50



Talocha limpieza esponja compacta mango blanco

Compact cleaning sponge smoother white handle
Lisseur éponge compact pour propreté mangue blanche

ref	mm	box
566512	280x140x30	1/10



Talocha limpieza esponja cortada mango blanco

Cut cleaning sponge smoother white handle
Lisseur éponge coupe pour propreté mangue blanche

ref	mm	box
566513	280x140x30	1/10



Llana para juntas

Grouting float
Platoir a jointers

ref	mm	box
905LJ0	240x100	1/10/50



Llana para rejuntar

Grouting float
Platoir a jointer

ref	mm	box
566514	280x140	1/10



Llana para juntas recia

Grouting fort float
Platoir a jointers fort

ref	mm	box
905LJ1	255x100	1/10/50



Llana para juntas blanda

Grouting soft float
Platoir a jointers doux

ref	mm	box
905LJ2	240x95	1/10/50



Remolinador poliéstireno extruido punta

Tip smoother
Pointe lisseur

ref	mm	box
568R01	240x140x40	1/55

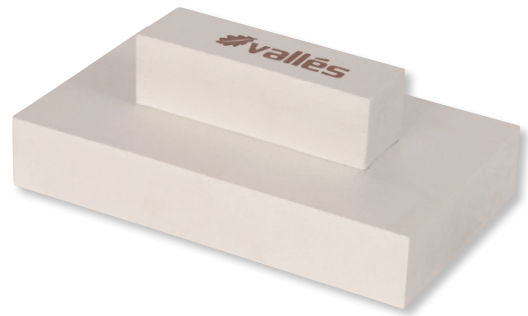

Remolinador poliéstireno extruido cuadrado

Square smoother
Carré lisseur

ref	mm	box
568R02	240x140x40	1/55



Remolinador punta espuma blanca mango poliéstireno reticulado trapezoidal

Tip smoother foam tip white trapezoidal handle
Pointe lisseur en mousse blanche manque trapézoïdale

ref	mm	box
568E02	255x140x55	1/10



Remolinador espuma blanca cuadrado mango con poliéstireno reticulado trapezoidal

Square smoother white foam handle trapezoidal foam
Carré lisseur mousse blanche mousse poignée trapézoïdale

ref	mm	box
568E01	255x140x55	1/10



Remolinador punta poliéstireno reticulado blanca mango plástico

Tip smoother foam tip white plastic handle
Pointe lisseur en mousse blanche manque plastique

ref	mm	box
568B02	240x120	1/10



Remolinador cuadrado poliéstireno reticulado blanca mango plástico

Square smoother white foam plastic handle
Carré lisseur mousse blanche mousse manque plastique

ref	mm	box
568B01	240x120	1/10



Rascador pequeño rejilla
Little lattice structure plane
Rabot petit

ref	mm	box
669005	285x140	1/10/30



Rascador monocapa mango normal
Scraper round handle
Gratton poignée ronde

ref	mm	box
663RB2	250x144	1/10

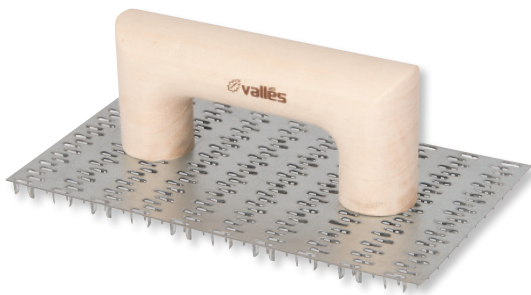

Rascador monocapa mango redondo
Scraper normal handle
Gratton poignée normale

ref	mm	box
663RV3	250x144	1/10

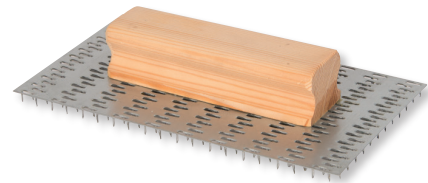

Rascador monocapa mango pizarra pequeño
Little lattice structure plane barbed
8 mm
Rabot petit manche d'ardoise barbelé
8 mm

ref	mm	box
663RP1	150x72	1/60
663R01	250x144	1/10

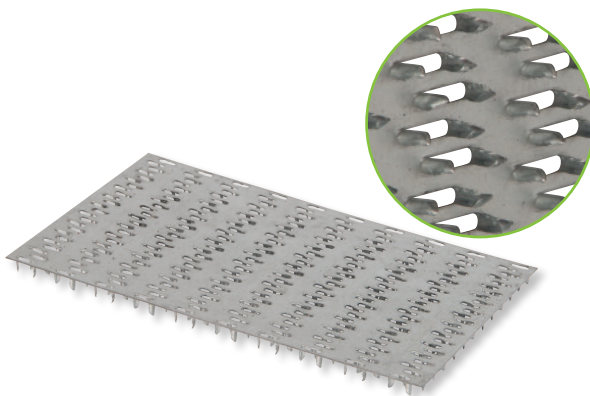

Recambio rascador monocapa (uds.)
Spare part tooth leaf
Rechange lame denté

ref	mm	box
663RRP	73x150	1
663RR2	144x250	1
663RR0	144x250	80



Rascador planchas XPS (uds.) para sistemas SATE
Spare part plate
Rechange plaque

ref	mm	box
663RB1	350x150	15
663RP3	350x150	40 recambio

**Cepillo dentado para monocapa**Toothed plane
Rabot denté

ref	mm	box
663CM1	16	1

**Cortafríos**Chisel
Ciseau

ref	mm	box
803020	200x25x10	1/10/60
803025	250x25x10	1/10/60
803030	300x25x10	1/10/60

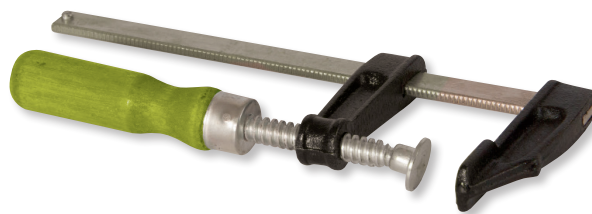
**Tornillo de apriete bricolaje**Tightening screw for bricolage
Vis serrage pour bricolage

ref	mm	box
667150	50x150	1/50

**Lijadora de mano tela abrasiva grano para sistema sate**Hand sander grinding abrasive cloth for sate system
Ponceuse à main abrasive pour le système sate

ref	mm	box
701043	270x130	1/15

**Maza de goma**Rubber Mallet
Maillet Caoutchouc

ref	mm	g	box
664J15	Ø50	500	1/6/24

Recambio lija abrasiva grano 16Replacement 16 grit abrasive sandpaper
Remplacement Papier abrasif abrasif 16 grains

ref	mm	box
425004	266x125	10



Alcotana mango bimaterial

Pickaxe wood handle
Décintroid à hache manche en bois

ref	mm	box
664J10	300x230	1/6/24



Piqueta pala 550 gr

Spade pick
Décintroid à pic

ref	mm	box
664J03	330x300	1/6



Piqueta albañil z mango bimaterial

Bricklayer pick wood handle
Martelette à brique manche en bois

ref	mm	box
664J04	330x200	1/6/24



Maceta modelo español 1 kg

Hammer spanish model 1 kg.
Massette modèle espagnol 1 kg.

ref	mm	box
664JC7	265x125	1/6/24



Hacha encofrador mango goma tubular

Former axe tubular rubber handle
Hachette de plâtier poignée en caoutchouc tubulaire

ref	mm	box
664J09	320x170	1/6/24



Mango de fibra bimaterial

Fibre handle
Manche du fibre

ref	mm	box
663M25	ø 26 - h 330	1



**Regle con nivel aluminio
doble asa ergonómica**

AluminiLevel rule double ergonomic handle
Règle de niveau de double poignée ergonomique

ref	mm	box
664U15	1500	1/10
664U20	2000	1/10
664U25	2500	1/10



Nivel de aluminio

Aluminium level
Niveau d'aluminium



ref	mm	box
664NE1	400x50x20	1/10/50
664NE2	500x50x20	1/10/50
664NE3	600x50x20	1/10/50
664NE4	800x50x20	1/10/50
664NE5	1000x50x20	1/10/50
664NE6	1200x50x20	1/10/30
664NE7	1500x50x20	1/10/30
664NE8	2000x50x20	1/10/30

**Nivel de aluminio
magnético**

Magnetic aluminium level
Niveau d'aluminium magnétique



ref	mm	box
664ME1	400x50x20	1/10/50
664ME2	500x50x20	1/10/50
664ME3	600x50x20	1/10/50
664ME4	800x50x20	1/10/50
664ME5	1000x50x20	1/10/50
664ME6	1200x50x20	1/10/30
664ME7	1500x50x20	1/10/30
664ME8	2000x50x20	1/10/30



**Tubo PVC transparente
para nivel de agua**

Transparent PVC pipe for water level
Tuyau en PVC transparent pour le
niveau de l'eau

ref	mm	box
6640T1	øin-ex: 10-14	1 (50m)
6640T101	øin-ex: 10-14	1 (25m)



Nivelador de suelos

Floor level
Niveau du sol

ref	mm	box
664NS1	400x20x40	1/50/BP

Legón con mango de madera

Hoe with wooden handle
Houe avec manche du bois

ref	mm	box
702L00	900x200x180	1/5



Legón con mango de hierro

Hoe with iron handle
Houe avec manche du fer

ref	mm	box
702L02	900	1/5



Legón media luna con mango de madera

Half moon hoe with wooden handle
Houe demi-lune avec manche du bois

ref	mm	box
702L04	900	1/5



Mango de madera para legón

Wood handle for hoe
Manche du bois pour houe

ref	mm	box
663M37	ø35x385	1



Raedera media luna mango aluminio

Half moon road scraper with aluminum handle
Racloir demi-lune avec manche du bois

ref	mm	box
702ML0	1400	1



Raedera media luna sin mango

Half moon road scraper without handle
Racloir demi-lune sans manche

ref	mm	box
702MLB	900	1



Repartidor de cemento con mango aluminio

Distributor for cement with aluminum handle
Livreur pour ciment avec manche du bois

ref	mm	box
702RC1	400	1

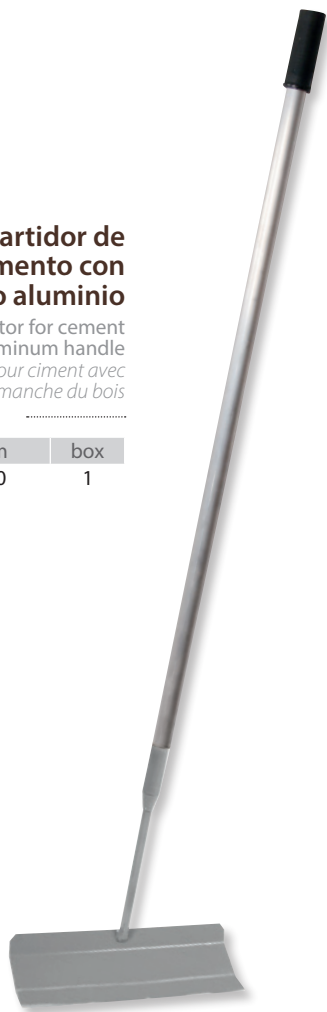

Repartidor de cemento con mango de tubo de hierro

Distributor for cement with iron pipe handle
Livreur pour ciment avec manche du tuyau du fer

ref	mm	box
702RC2	400	1

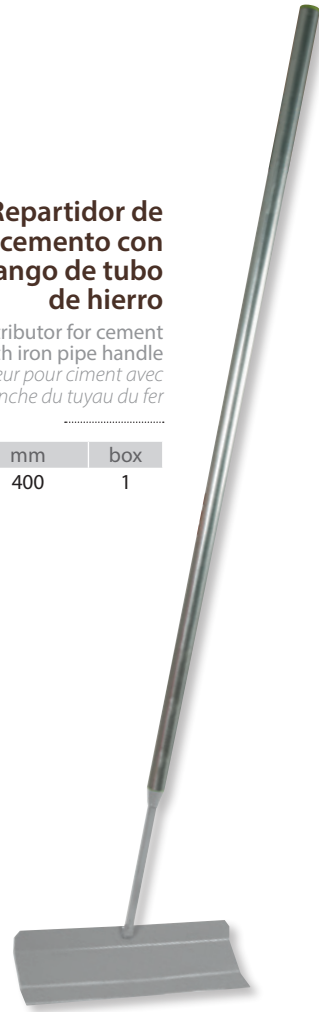

Rasqueta de acero galvanizado con mango de madera

Galvanized steel scraper with wooden handle
Rasque acier galvanisé avec manche du bois

ref	mm	box
702RR0	200	1/6



Rascador de suelo reforzado con mango de madera

Reinforced soild scraper with wooden handle
Racloir sol renforcé avec manche du bois

ref	mm	box
663RR3	300	6
663R03	500	B/P



Rascador de suelo con mango de madera

Floor scraper with wooden handle
Racloir de sol avec manche en bois

ref	mm	box
663R02	300	6
663R00	150	6

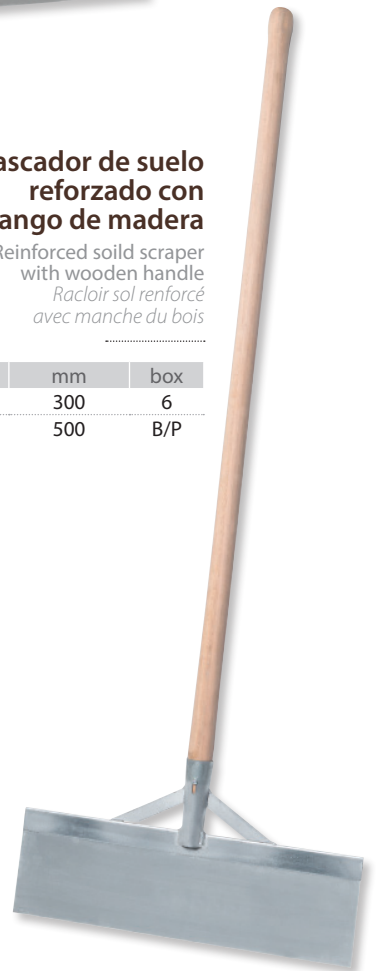



Pala redonda con mango en fibra bimaterial en anilla

Round shovel with crutch handle
Pelle ronde avec poignée béquille

ref	mm	box
702RF1	1078x300x340	1



Pala cuadrada con mango en fibra bimaterial en anilla

Square shovel with handle ring
Pelle carrée avec manche du anneau

ref	mm	box
702CF1	1078x280x350	1

**Pastera construcción galvanizada sin refuerzo**

Mixing container
for construction unreinforced
*Caisse à gâcher
pour construction non armé*

ref	l	box
662C01	100	1/10
662C02	165	1/10

**Pastera construcción galvanizada reforzada**

Mixing container
for construction reinforced
*Caisse à gâcher
pour construction armé*

ref	l	box
662CR2	165	1/10
662CR3	190	1/10



Borriqueta plegable galvanizada

Simple galvanized folding seat board
Chevalet pliage galvanisé simple

ref	mm	box
300C14	800	1/20
300C08	1000	1/20
300C10	1200	1/20
300C09	1500	1/20



Borriqueta plegable galvanizada doble travesaño

Galvanized folding double seat board
Chevalet pliage de siège pliant galvanisé

ref	mm	box
300CD14	800 (3 trav.)	1/20
300CD8	1000 (4 trav.)	1/20
300CD9	1500 (5 trav.)	1/20



Banqueta especial regulable galvanizada

Special adjustable galvanized bench
Banc galvanisé réglable spécial

ref	mm	box
300E06	740-1200	1/20



Banqueta regulable galvanizada

Adjustable galvanized bench
Banc galvanisé réglable

ref	mm	box
300006	850-1150	1/20
300016	600-1500	BP

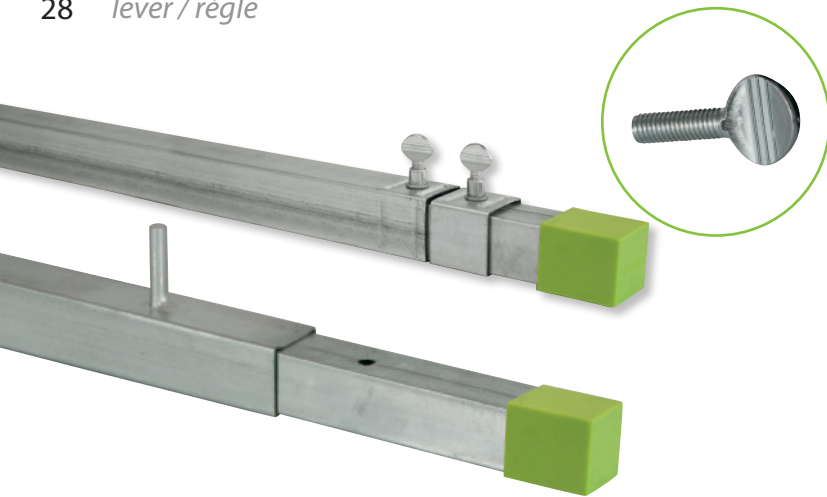

Regle muelle construcción 2 palomillas con apoyo de pie

2 moths galvanized construction spring lever with foot support
Règle ressort construction galvanisé 2 papillons avec soutien pied

ref	mm	box
304MD3A	1820-3150	5/144
304MD4A	2330-3600	3/126
304MD7	2790-4900	3/144
304MD8	3370-5480	1/BP



Regle de yesero fijo galvanizado

Galvanized fixed lever
Règle fixée galvanisé

ref	mm	box
304K02	40x20x1500	1/BP
304K03	40x20x2000	1/144
304K04	40x20x2500	1/144
304K05	40x20x3000	1/144
304K06	40x20x2600	1/BP
304K07	40x20x3500	1/BP

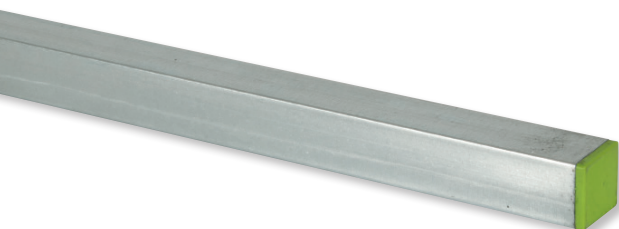

Regle fijo galvanizado

Galvanized fixed lever
Règle fixée galvanisé

ref	mm	box
304F01	40x40x1000	1/BP
304F02	40x40x1500	1/BP
304F03	40x40x2000	1/144
304F04	40x40x2500	1/144
304F05	40x40x3000	1/144
304F06	40x40x3500	1/144
304F07	40x40x4000	1/144
304F11	40x40x6000	1/BP



Juego soporte de reglas

Game support levers
Jeu soutien du règles

ref	mm	box
304SP0	300	1

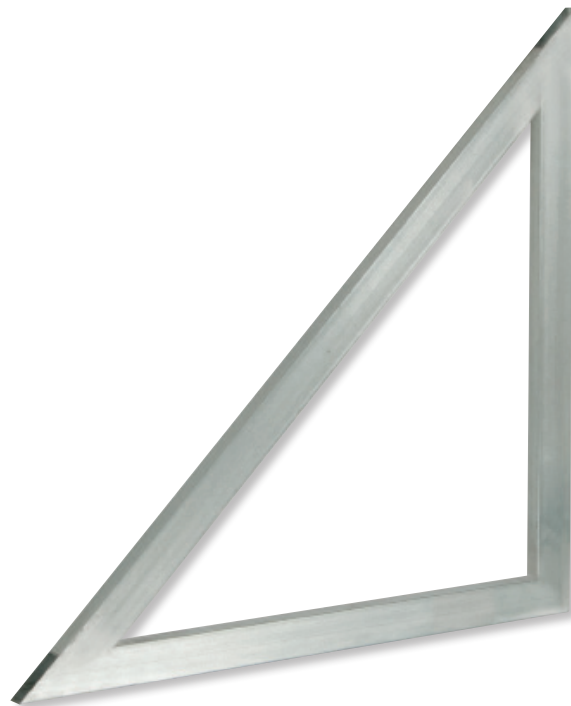

Escuadra galva

Galvanized square
Équerre galvanisé

ref	mm	box
660CG1	600	1
660CG2	800	1
660CG3	1000	1

**Junquillo monocapa
PVC gris**

PVC monolayer jonquil
Jonquille monocouche pvc

ref	mm	box
303J20	20x2000	130

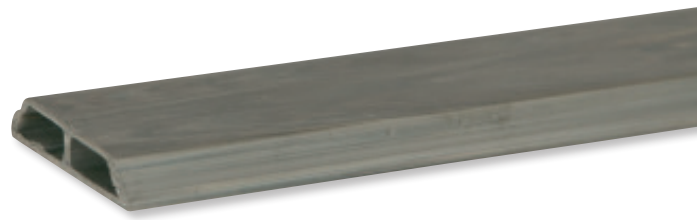

**Guardavivo PVC
monocapa punta fina/
tabique**

Pointed fine / thin wall monolayer
PVC corner protector
*Main courante PVC monocouch pointe
bon / cloison*

ref	mm	box
303T25	2500	60

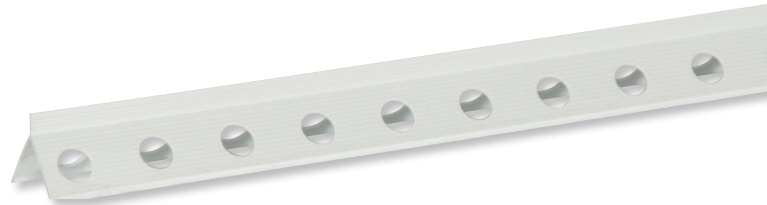

**Guardavivo PVC
fachada grande**

Big frontage PVC corner protector
Main courante PVC façade grand

ref	mm	box
303FG1	2600	60/BP

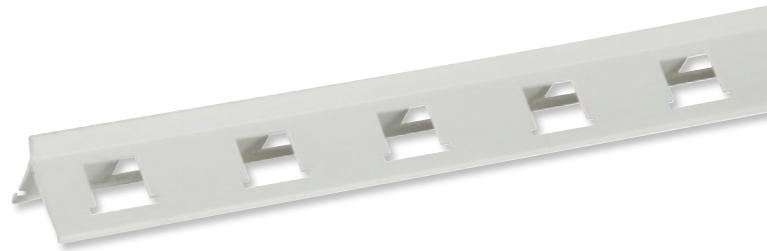

**Guardavivo galvanizado
4 mallas**

Galvanized lifeguard 4 meshes
Sauveteur galvanisé 4 mailles

ref	mm	box
3034G1	2500	50/BP

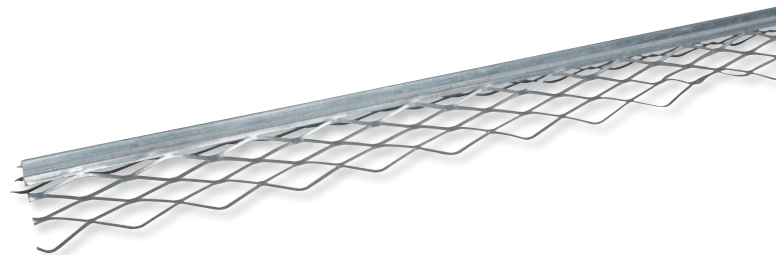

**Guardavivo yeso
galvanizado**

Plaster lifeguard galvanized
Sauveteur en plâtre galvanisé

ref	mm	box
303MG1	2500	30/BP





Capazo de plástico negro

Black plastic basket
Cabas du plastique noir

ref	l	box
907C55	55	1/12
907C75	75	1/5



Capazo de plástico negro con asa ergonómica

Black plastic basket
Cabas du plastique noir

ref	l	box	palet
907C14	14	1/12	792
907C26	26	1/12	648
907C42	42	1/12	540



Cubo de plástico

Plastic basket
Cabas du plastique

ref	l	box
666009	6	1/24
666010	8	1/24
666011	12	1/24
666013	16	1/24



Caldereta de albañil

Stew mason
Cabas du plastique

ref	l	box
907C15	15	1/12



Capazo
Basket
Cabas

ref	l	box
906002	60	1/5



Capazo
Basket
Cabas

ref	l	box
906019	18	1/10



Cubo italiano
Italian bucket
Seau italien

ref	l	box
906006	10	1/10



Espuerta
Basket
Cabas

ref	l	box
906012	11	10



Capazo de carbonera
Coal basket
Cabas charbonnière

ref	l	box
906018	30	1/10



Tiralíneas plomado de plástico 20 m.

20 m. plastic tracer
Traceur de plastique 20 m.

ref	mm	box
810PJ0	150x75x30	1/25



Polvo para trazar

Powder to draw
Poussière pour dessiner

ref	grs	box
810A03	250	1/10/60
810A02	1000	1/12



Tiralíneas bimaterial 30 m.

30 m. bimaterial tracer
Traceur bimatérial 30 m.

ref	mtrs	box
810PJ1	30	1/6/36

Incluye 115 gr. de polvo trazador.



Fleje de obra perforado

Work hoop perforated
Cerceau de fer perforé

ref	mm	box
606050	ø16-b/50 m	1/104
606100	ø16-b/100 m	1/102

(0,65±0,05)



Garra

Grip
Ustensile pour fixer

ref	mm	box
660001	puerta	1/32
660002	ventana	1/32



Tapón poste valla

Metallic stopper
Bouchon clôture

ref	mm	box
902T45	45	500



Cantonera

Flange angle
Coin

ref	mm	box
663C04	40x40x50	500
663C00	40x40x100	250



Pistola silicona
Silicone gun
Pistolet pour silicone

ref	mm	box
701044	30	1/12



Tenaza alicatador
Tiler tong
Pince carreleur

ref	mm	box
701046	30	1/12



Tenazas para porcelánico
Pliers for porcelain
Pinces pour greocerame

ref	mm	box
701047	30	1/12



Tenaza rusa verde 9"
mango de plástico
Russian tong
Tenaille ruse

ref	mm	box
667009	235x50x45	1/6/60



Tenaza carpintero verde
8" mango de plástico
Carpenter tong
Tenaille charpentier

ref	mm	box
667016	205	1/6



Casco de construcción blanco

White construction helmet
Casque blanc pour construction

ref	mm	box
845B01	27x21,5	1/20



Cinturones profesionales de piel

Leather professional belt
Ceinture professionnelle du cuir

ref	mm	box
846001	54x23	1/25/300

Calentador de inmersión inoxidable 1500w

Rustproof immersion heater
1500w
Chauffe immersion inoxydable 1500w

ref	mm	box
851000	2200x1000	1

CARACTERÍSTICAS
 - 230 V. 1500 W.
 - Cable: 0,7 m.
 - 6x6x29 cm.
 - 0,2 kg.
 Protección de sobrecalentamiento.



Flexómetro con freno

Curve meter
Mètre

ref	mm	box
811004	3000	1/10/100



Flexómetro magnético con freno y punta imantada

Magnetic curve meter with brake and magnetic tip
Mètre magnétique avec frein et pointe magnétique

ref	mm	box
811025	5000x25	1/10/50



CONDICIONES DE VENTA

Rafael Vallés Arándiga, S.L.

Cuestiones generales

- Las presentes condiciones regirán para todas las ventas realizadas por Rafael Vallés Arándiga, S.L. El cliente se somete a ellas por el mero hecho de confirmar, cumplimentar y recibir los pedidos efectuados a Rafael Vallés Arándiga, S.L.
- El suministro se entenderá efectuado en los locales propiedad de Rafael Vallés Arándiga, S.L., viajando la mercancía por riesgo del cliente.
- Rafael Vallés Arándiga, S.L. se reserva el dominio de la mercancía vendida hasta que el precio de la misma haya sido totalmente satisfecho. Hasta dicho momento, el cliente se obliga a manifestar ante terceros tal reserva de dominio, respondiendo de los daños y perjuicios que por omisión de esta obligación se ocasionen a Rafael Vallés Arándiga, S.L., y sin perjuicio de las responsabilidades en que pueda incurrir.
- Para cualquier cuestión derivada de la venta efectuada por Rafael Vallés Arándiga, S.L. serán competentes los Juzgados y Tribunales de la ciudad de Xàtiva.
- El modo de transporte será siempre a elección de Rafael Vallés Arándiga, S.L. Cuando el cliente elija otro medio de transporte diferente al ofrecido por Rafael Vallés Arándiga, S.L. los portes serán a su cargo.
- Salvo convenio especial, los plazos de entrega que se indiquen a los clientes tendrán carácter puramente informativo, y los retrasos o demoras que puedan producirse no darán derecho a indemnización.
- Toda tarifa de productos, general o específica, queda sujeta a modificaciones sin previo aviso.

Incidencias

- Rafael Vallés Arándiga, S.L. no acepta ninguna reclamación por aplicación errónea de sus productos.
- Todos los productos que sean suministrados por Rafael Vallés Arándiga, S.L. están garantizados contra cualquier defecto de

fabricación, cubriendo esta garantía la reposición del artículo defectuoso, pero no los portes que se originen. Esta garantía no cubre los defectos producidos como consecuencia de la mala utilización de la herramienta.

- No se aceptará reclamación alguna sobre la mercancía una vez transcurridas 24 horas desde la fecha de recepción de la misma.
- No se admitirán devoluciones transcurridos 15 días a partir de la fecha de entrega de la mercancía.
- Previamente a toda devolución es imprescindible la autorización por parte de Rafael Vallés Arándiga, S.L.
- En caso de haber devolución dentro del plazo estipulado y por motivos ajenos a Rafael Vallés Arándiga, S.L., será siempre a portes pagados por el cliente.
- El abono se realizará por el valor de la mercancía según los precios vigentes en la fecha de compra, reservándose Rafael Vallés Arándiga, S.L. el derecho de descontar de dicho abono el material deteriorado, así como los gastos de manipulación.
- Los artículos marcados bajo las siglas F.E. (Fabricación Especial) y B.P. (Bajo Pedido) en su descripción, no son susceptibles de devolución.
- Toda mercancía dañada por el medio de transporte (agencia) deberá ser notificada a ésta mediante la notificación en el albarán de recepción. De no ser así, Rafael Vallés Arándiga, S.L. no se hace responsable de dicha mercancía.

Facturación

- El importe de los abonos será descontado en la próxima factura que se produzca y notificado así al cliente.
- La primera venta realizada por Rafael Vallés Arándiga, S.L. hacia clientes nuevos será abonada mediante transferencia anticipada.
- Los gastos de devolución de documentos de cobro se realizarán a cargo del cliente.



Rafael Vallés Arándiga. S.L

Herramientas para escayola, construcción y bellas artes.

Tel. 96 225 43 83 - Fax: 96 292 81 20

ventas@rafaelvalles.com - info@rafaelvalles.com

Partida Terrers s/n - Llanera de Ranos 46814 (Valencia)

www.rafaelvalles.com