

Pool & Home

Private pools & Interiors

ezarri

ezarri

Mosaic Devotees

Recycled glass mosaic
manufacturers,
since 1979

Index

05	About Ezarri
25	Pool
89	Home
107	Collections

Dreams are made of mosaics

(ENG)

Over 40 years making dreams come true around the world, delivering 100% recycled glass mosaic solutions that turn **swimming pools, interiors, wellness areas and spas** into stunning places.

(ESP)

Más de 40 años haciendo realidad los sueños de personas de todo el mundo fabricando soluciones decorativas con mosaico de vidrio 100% reciclado que convierten **piscinas, interiores, Wellness y Spas** en espacios evocadores.

(FRA)

Plus de 40 ans à faire réalité les rêves de personnes du monde entier en fabriquant des solutions décoratives avec la mosaïque de verre 100% recyclé qui transforment **piscines, intérieurs, Espaces de Bien-être et Spas** en espaces évocateurs.

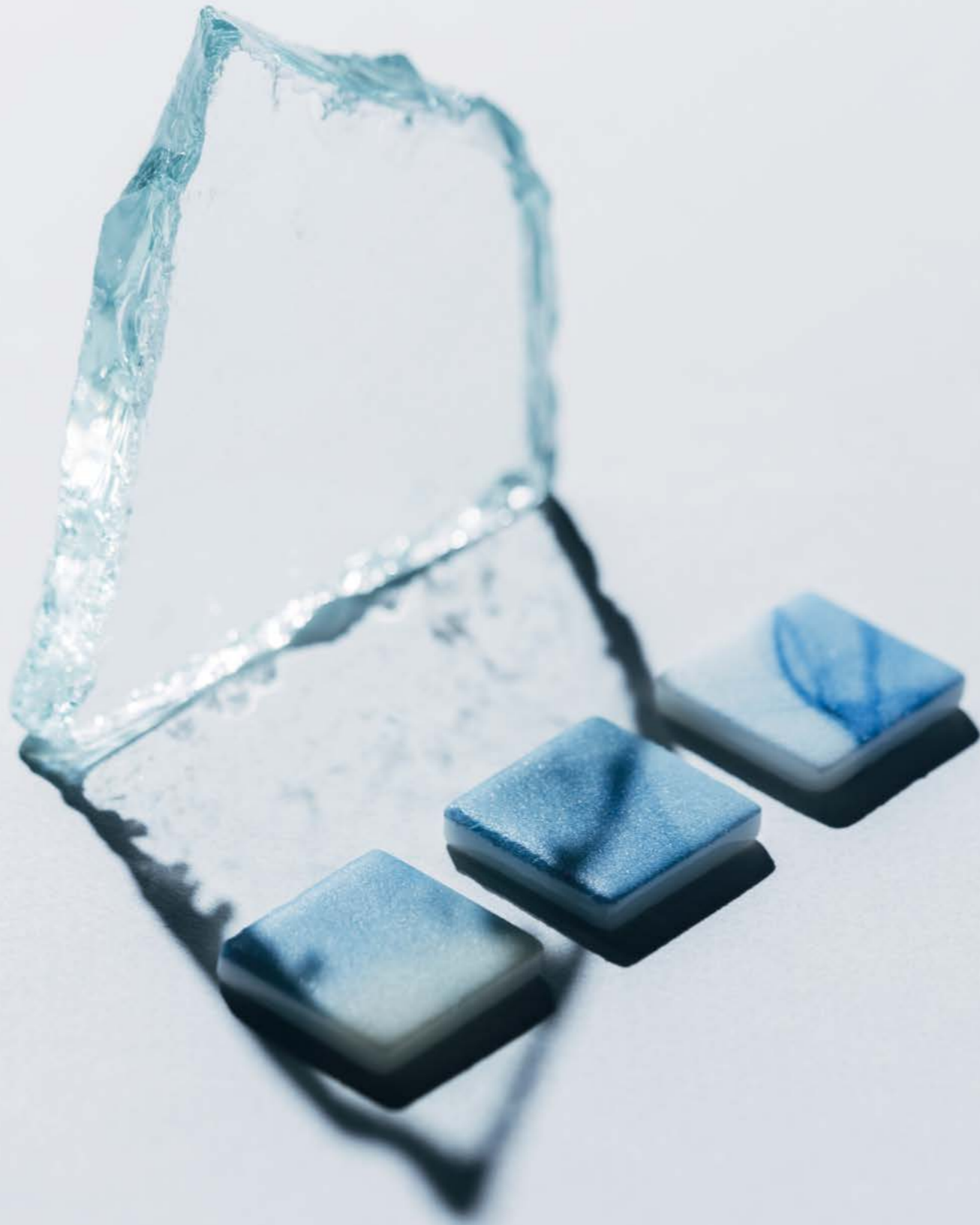

(ENG)

Dedicated entirely to glass mosaic, **our technical expertise and manufacturing capabilities** allow us to create innovative solutions inspired by avant-garde design and produced to the **highest quality and standards.**

Our recycled glass mosaic tile is manufactured entirely at our facility in Lazkao, Spain. This allows us to be extremely demanding when it comes to achieving the best results, and totally **flexible in meeting our customers' needs.** Our unwavering commitment to design, together with our approach to technology and production, has positioned us as a **world leader in glass mosaic tile.**

(ESP)

Nuestro **expertise técnico y productivo**, totalmente especializado en el mosaico de vidrio, nos permite crear soluciones innovadoras inspiradas en la vanguardia y el diseño, y producidas con la máxima **calidad y exigencia.**

Fabricamos el 100% de nuestro producto a partir de cristal reciclado y lo hacemos en nuestras instalaciones de Lazkao (España), eso nos permite ser extremadamente rigurosos con el resultado final de nuestras soluciones además de absolutamente **flexibles con las necesidades de nuestros clientes.** Nuestra continua apuesta por el diseño, sumado a nuestro enfoque productivo/tecnológico, nos han posicionado como **referentes del mosaico de vidrio a nivel mundial.**

(FRA)

Notre **expertise technique et productive**, totalement spécialisée dans la mosaïque de verre, nous permet de créer des solutions innovatrices inspirées de l'avant-garde et du design, et produites avec la **qualité maximale et de l'exigence.**

Nous fabriquons 100% de notre produit à partir de verre recyclé et nous le faisons dans nos installations de Lazkao (Espagne), cela nous permet d'être extrêmement rigoureux avec le résultat final de nos solutions mais aussi absolument **flexibles avec les besoins de nos clients.** Notre pari continu pour le design, ajouté à notre vision productive/technologique, ont fait de nous une **référence de la mosaïque de verre à niveau mondial.**

ezarri

A story of evolution



(ENG)

We **specialise exclusively in recycled glass mosaic tile**, which is why we make it better than anyone else. It's a lifelong passion, a genuine devotion to craftsmanship based on conviction, care, dedication and quality that's hard to beat.

In 1982 we began our international journey, **exporting to more than 100 countries worldwide** and positioning ourselves as a premium brand in the global market. Backed by a team of experts, R+D+i and design departments, together with a production plant spanning over **10,000 square metres**, we can now oversee every stage of the process. This allows us to ensure the quality of the more than **8,000 square metres of mosaic tile** manufactured every day among our product range of over 300 types of mosaic.

Throughout our 40-year history we have maintained our determination and firm commitment to **continuous improvement and incorporating new technologies**. This experience allows us to **set our own rules**. Not only are we time-tested experts in glass mosaic, but also experts in delivering on every commitment.

(ESP)

Somos especialistas **dedicados exclusivamente al mosaico de vidrio reciclado** y, por eso precisamente, lo hacemos mejor que nadie. Es un amor para toda la vida, una devoción verdadera que nos lleva a fabricar con convicción, mimo, dedicación y con una calidad difícil de imitar.

En 1982 comenzamos nuestra andadura internacional, situándonos como una marca referente en el mercado mundial que **exporta a más de 100 países del mundo entero**. Desde entonces, y de la mano de nuestro equipo experto, de nuestros departamentos de I+D+i y diseño, y con unas instalaciones productivas de más de **10.000m²**, somos capaces de controlar cada fase del proceso para asegurar la calidad de los más de **8.000m² de mosaico** que fabricamos al día de entre nuestras más de **300 referencias**.

Una trayectoria de 40 años en la que hemos mantenido nuestro carácter comprometido y nuestra determinación por mejorar mediante la **incorporación permanente de innovaciones**. Eso nos permite, no sólo **crear nuestras propias reglas**, sino poder afirmar y asegurar que, además de ser expertos y especialistas en el mosaico de vidrio, también lo somos en la manera en la que cumplimos con todo aquello a lo que nos comprometemos.

(FRA)

Nous sommes des spécialistes qui se **consacrent exclusivement à la mosaïque de verre recyclé**, c'est pour cela précisément que nous le faisons mieux que personne. C'est un amour pour toute la vie, une dévotion véritable qui nous amène à fabriquer avec conviction, soin, dévouement et une qualité difficile à imiter.

En 1982, nous avons commencé notre parcours international, en devenant une marque de référence dans le marché mondial qui **exporte à plus de 100 pays du monde entier**. Depuis, et de la main de notre équipe experte, de nos départements de R&D et Innovation et design, et avec des installations productives de plus de **10.000 m²**, nous sommes capables de contrôler chaque phase du processus pour garantir la qualité des plus de **8.000 m² de mosaïque** que nous fabriquons chaque jour parmi les plus de **300 références** que sont les nôtres.

Une trajectoire de 40 ans durant laquelle nous avons conservé notre caractère engagé et notre détermination pour améliorer au moyen de **l'incorporation permanente d'innovations**. Cela nous permet, non seulement de **créer nos propres règles**, mais aussi de pouvoir affirmer et garantir que, en plus d'être experts et spécialistes en mosaïque de verre, nous le sommes aussi dans la manière selon laquelle nous respectons notre engagement.



From Green to Dream

100% recycled glass

(ENG)

Our product is aligned **100% with circular economy** and our production process based exclusively on **recycled glass**, thus protecting the environment and mitigating climate change. For over four decades we have been working sustainably with recycled window glass, driven by a steadfast commitment to quality and respect at every turn regarding products, raw materials, people and the environment.



100% recycled glass
Over the 96% of the end product is from recycled glass



ISO 14021 Certification
by Bureau Veritas

(ESP)

Nuestro producto es **100% fruto de la economía circular**. Un proceso productivo que parte siempre y de manera exclusiva del **vidrio reciclado**, contribuyendo así a la protección del medio ambiente y el cambio climático. Más de cuatro décadas reciclando vidrio de ventanas con una actitud sostenible que demuestra que nuestro compromiso con la calidad es firme y honesto y está estrechamente ligado al respeto en todos sus ámbitos: con el producto, con la materia prima, con las personas y con nuestro entorno.

(FRA)

Notre produit est **100% fruit de l'économie circulaire**. Un processus productif qui part toujours et de manière exclusive du **verre recyclé**, en contribuant ainsi à la protection de l'environnement et au changement climatique. Plus de quatre décades à recycler du verre de fenêtres avec une attitude durable qui démontre que notre engagement avec la qualité est ferme et honnête mais aussi qu'il est étroitement lié au respect dans tous les sens du terme : avec le produit, avec la matière première, avec les personnes et avec notre environnement.

Six reasons for choosing ezarri glass mosaic

Las 6 razones por las que elegir mosaico de vidrio ezarri

Les 6 raisons pour lesquelles choisir la mosaïque de verre ezarri

1

Customer service

We live up to our word. We provide our customers with serious, professional service to deliver the best possible solution and engage them in the experience.

Atención al cliente: Cumplimos con nuestra palabra. Acompañamos a nuestros clientes con seriedad y profesionalidad para ofrecerles siempre la mejor solución, haciéndoles vivir una experiencia relevante.

Service client: Nous tenons notre parole. Nous accompagnons nos clients avec sérieux et professionnalisme pour leur offrir la meilleure solution possible, leur faisant vivre une expérience remarquable.

2

Quality

Technology, style, performance and design come together in a product of uncompromising quality. The highest quality is also ensured throughout the production process, service, transparency, and the final result. Because for Ezarri, quality means respecting our product and our customers.

Calidad del producto: Unión de técnica y estética, funcionalidad y diseño para un producto de calidad absoluta. Pero calidad también en todo el proceso de producción, en el servicio, en la transparencia, en el resultado final. Porque calidad es para Ezarri respeto por el producto y por nuestros clientes.

Qualité du produit: Union de technique et d'esthétique, de fonctionnalité et de design pour un produit de qualité absolue. Mais de la qualité aussi durant tout le processus de production, dans le service, dans la transparence, dans le résultat final. Parce que la qualité est pour Ezarri le respect envers le produit et envers nos clients.

3

Customisation

Our mix generator allows you to create your own composition from our wide range of mosaic tiles. Or if you prefer, we can make a bespoke design for your project using our digital print system.

Posibilidad de personalización: Contamos con un generador de mezclas que te ayudará a crear tu propia composición a partir de nuestra amplia gama de mosaicos. O, si lo prefieres, podemos plasmar el dibujo que quieras gracias a nuestros sistema de impresión digital.

Possibilité de personnalisation: Nous comptons sur un générateur de mélanges qui vous aidera à créer votre propre composition à partir de notre ample gamme de mosaïques. Ou, si vous le préférez, nous pouvons reproduire le dessin que vous souhaitez grâce à notre système d'impression numérique.

4

Eco-friendly

Our origins are rooted in sustainability. 100% recycled glass. 14021 Certification is our seal of approval.

Alma eco: Nuestro origen que parte de lo sostenible. Vidrio 100% reciclado. Nuestra Certificación 14021 nos avala.

Alma eco: Notre origine qui part de la durabilité. Verre 100% recyclé. Notre Certification 14021 le garantit.

5

Perfect for swimming pools

The almost zero water absorption rate and resistance to chemical corrosion help to keep Ezarri pools unaltered over time.

Indicado para piscinas: La casi nula absorción de agua unida a la resistencia del mosaico al producto químico ayudan a mantener las piscinas Ezarri en condiciones excelentes

Recommandé pour piscines: La quasi nulle absorption d'eau unie à la résistance de la mosaïque au produit chimique aide à maintenir les piscines Ezarri dans de conditions excellentes.

6

24/48-hour delivery

We manufacture all our mosaics and we have 95% of our style references in our automated warehouse. This allows us to have orders ready in 24-48 hours from confirmation.

Suministro en 24/48 horas: Fabricamos todos nuestros mosaicos y en nuestro almacén automatizado disponemos del 95% de nuestras referencias, pudiendo tener los pedidos preparados en 24/48 horas desde su confirmación.

Mise à disposition de la marchandise en 24/48 heures: Nous fabriquons toutes nos mosaïques et dans notre entrepôt automatisé nous disposons de 95% de nos références, ce qui nous permet d'avoir les commandes prêtes en 24/48 heures après sa confirmation.



JointPoint®

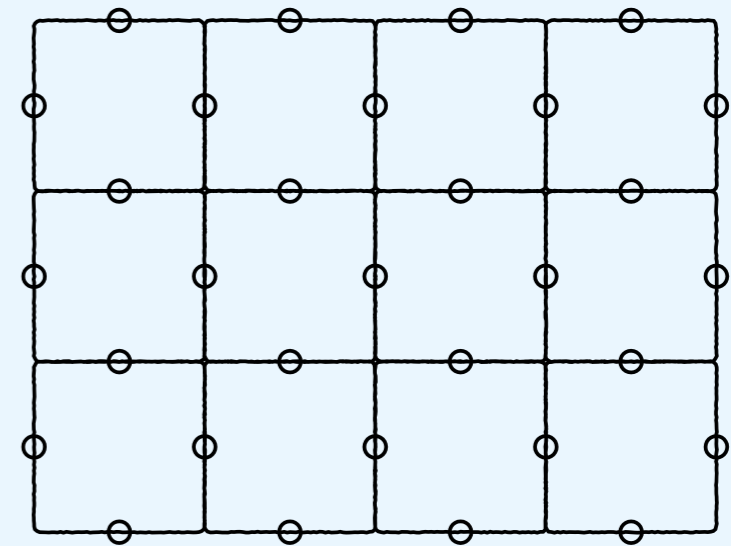

“It’s not (only) the technology. It’s defining the exact point.”

Pioneers in a unique, revolutionary and technologically advanced system since 1991. Developed by Ezarri, **JointPoint®** provides easy, uniform installation of mosaic tile on any surface.

(ESP)

“No es (sólo) la tecnología. Es la definición exacta de ese punto”

Pioneros desde 1991 de un sistema único, revolucionario y tecnológicamente avanzado. Desarrollado por Ezarri, el **JointPoint®** garantiza una instalación perfecta, sencilla y homogénea del mosaico en cualquier superficie.

(FRA)

“Ce n’est pas (seulement) la technologie. C’est la définition exacte de ce point”

Pionniers depuis 1991 d’un système unique, révolutionnaire et technologiquement avancé. Développé par Ezarri, **JointPoint®** garantit une installation parfaite, simple et homogène, de la mosaïque sur toute surface.

A small uniform point rigorously controlled

Un pequeño punto rigurosamente homogéneo y controlado.

Un petit point rigoureusement homogène et contrôlé.

Innovation, efficiency, performance and guarantee.
Innovación, eficacia, resultado y garantía.
Innovation, efficacité, résultat et garantie.

(ENG)

Technique is in our DNA. As expert manufacturers, we make the complex simple. Therein lies our unique competitive edge. Our **JointPoint®** system is a prime example of our commitment to technological precision and innovation.

- This system leaves **92% of the mosaic surface free for applying the adhesive**, which means much greater durability.

- Its unique composition adapts to any curve or shape, ensuring **maximum flexibility and strength**. Working around obstacles is straightforward with the simple, easy-to-cut system.

- Its flexibility and adaptability make it extremely easy to install, **saving up to 25% of installation time** compared to paper-based systems.

- As it is **not affected by moisture**, there is no expansion, shrinkage or breakage.

(ESP)

La técnica está en nuestro ADN. Como expertos fabricantes, hacemos simple lo complejo, esa es nuestra diferenciación singular y competitiva. Y nuestro sistema **JointPoint®** es la principal muestra de nuestro compromiso con la precisión tecnológica y la innovación.

- Un sistema que deja el **92% de la superficie del mosaico libre para aplicar la cola de agarre**, lo que se traduce en una enorme garantía de durabilidad.

- Su exclusiva composición consigue unas **prestaciones de maleabilidad y resistencia máximas**, capaces de adaptarse a cualquier curva y forma, así como de solventar obstáculos con un corte fácil, rápido y sencillo.

- Su flexibilidad y adaptabilidad hacen que su colocación sea enormemente sencilla, **ahorrando hasta un 25% del tiempo** en contraste con el empanelado en papel.

- Su **resistencia al agua y la humedad** evita cualquier dilatación, contracción o rotura.

(FRA)

La technique est dans notre ADN. En tant qu'experts fabricants, nous faisons simple ce qui est compliqué, là se trouve notre différenciation singulière et compétitive. Et notre système **JointPoint®** est la principale preuve de notre engagement avec la précision technologique et l'innovation.

- Un système qui **laisse 92% de la surface de la mosaïque libre** pour appliquer la colle d'adhésion, ce qui se traduit par une énorme garantie de durabilité.

- Sa exclusive composition offre des **prestations de malléabilité et de résistance maximales**, capables de s'adapter à n'importe quelle courbe et forme. Elle peut aussi éliminer des obstacles avec une coupe facile, rapide et simple.

- Sa flexibilité et son adaptabilité rendent la pose très facile, et permettent de **gagner 25% du temps** qui aurait été nécessaire avec la fixation papier.

- Sa **résistance à l'eau et à l'humidité** évite tout type de dilatation, contraction ou fissure.

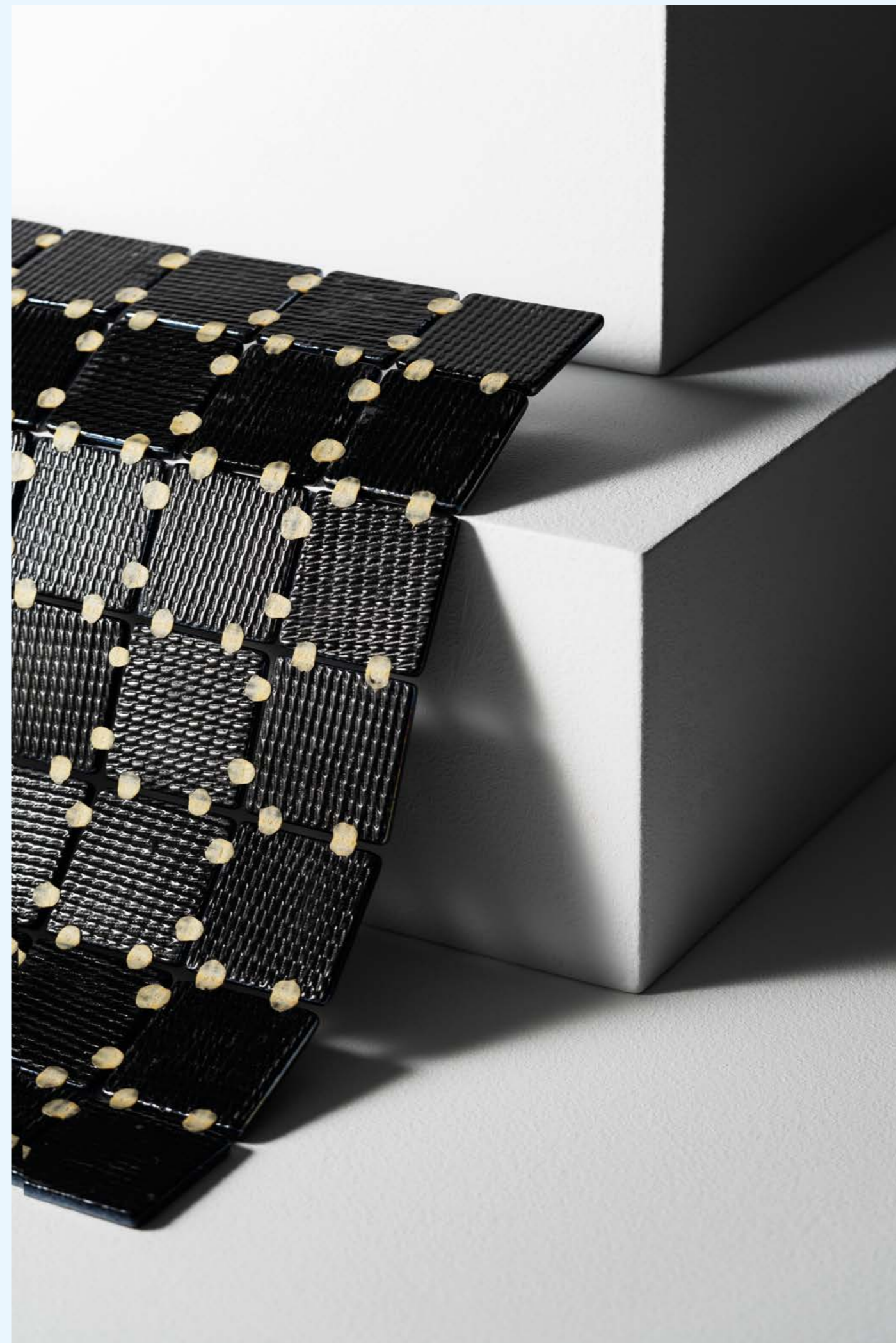

When water matters

What will the colour of the water look like in my pool?

¿De qué color se verá el agua de mi piscina?

Quelle sera la couleur de l'eau de ma piscine ?

(ENG)

The power of colour is boundless. It connects us to moments, sensations, emotions.... For this very reason, one of the most frequently asked questions for anyone planning to build the pool of their dreams is What colour do I want it to be and what mosaic tile should I choose?

Colour is determined by several factors, such as light, water depth, location and the scenery around your pool.

The deeper the pool, the deeper the colour. The shallower the pool, the lighter the colour. Another vital factor is sunlight. The amount of light that falls on the pool water will directly affect the shade and overall feel of the pool. The same goes for everything in the immediate environment, including any buildings that make the water appear darker or trees that reflect a greener tone.

And, of course, the glass mosaic chosen for the pool's finish. Your choice of tile will be an important factor for the water colour you're after. Transparent, turquoise blue, Tuscan green, sky blue...?

(ESP)

El poder del color es infinito. Consigue conectarnos con momentos, sensaciones, emociones... Y por eso mismo, una de las preguntas que más se hace quien va a construir la piscina de sus sueños es ¿qué color quiero que tenga y qué mosaico debo elegir para conseguirlo?

El color va estrechamente ligado a factores como la luz, la profundidad del agua, el lugar en el que se encuentra nuestra piscina y todo aquello que la rodea...

A piscinas con mayor profundidad, el efecto del agua sobre ellas será más oscuro. Y, del mismo modo, cuanto menos profundidad tenga la piscina, más clara se verá el agua sobre ella. Otro factor vital: la luz del sol. La cantidad de luz que incida sobre el agua de la piscina afectará también de manera directa al color claro y oscuro de su estética, así como todo aquello que rodee el espacio de piscina, como edificios que la hagan parecer más oscura o árboles que puedan reflejar en ella un tono más verdoso.

Y, por supuesto, el mosaico de vidrio elegido para revistirla. A diferencia de lo que puede parecer, depende del tono que busquemos, deberemos elegir uno u otro. ¿Transparente, azul turquesa, verde toscano, azul del cielo?

(FRA)

Le pouvoir de la couleur est infini. Il parvient à nous connecter avec des moments, des sensations, des émotions... Et pour cette raison, l'une des questions que se posent le plus souvent ceux qui vont construire la piscine de leurs rêves est : de quelle couleur je veux qu'elle soit ? Et pour obtenir cette couleur, quelle mosaïque dois-je choisir ?

La couleur est étroitement liée à des facteurs tels que la lumière, la profondeur de l'eau, l'endroit où se trouve notre piscine et tout ce qui l'entoure...

Dans les piscines plus profondes, l'effet de l'eau sera plus sombre. De même, moins la piscine est profonde, plus l'effet de l'eau sera clair. Un autre facteur vital : la lumière du soleil. La quantité de lumière qui tombe sur l'eau de la piscine changera également et directement la couleur claire et sombre de son esthétique, ainsi que tout ce qui entoure l'espace de la piscine, comme les bâtiments qui la feraient apparaître plus sombre ou les arbres qui peuvent y réfléchir un ton plus verdâtre.

Et, bien sûr, la mosaïque de verre choisie pour la recouvrir. Contrairement à ce que cela paraîtrait paraître, selon le ton que l'on recherche, il faut choisir l'un ou l'autre. Transparent, bleu turquoise, vert toscan, bleu ciel?



Perla 25 - Iridescent Collection

White tone mosaics

Carrara, Perla, Diamond 2545-A

Mosaics with white tones make the water a pale sky blue.

Darán a la piscina unos tonos de **agua azul cielo claro**.

Elles donneront à la piscine des nuances d'eau **bleu ciel clair**.



Ash 25 - Zen Collection

Beige and pink mosaics

Ash, Marfil, Arena, Nacar, 2514-B, 2576-B, 2596-B, 2597-B, 2523-B

Mosaics with beige or pink tones, ranging from lighter to darker, give the **water a greenish hue**.

Son perfectos para obtener **tonos de agua verdoso** en la piscina, que van desde los tonos más claros a otros más oscuros.

Parfaites pour obtenir des tons d'eau **verdâtre** dans la piscine, allant des tons les plus clairs aux plus foncés.



Sarsen 25 - Zen Collection

Grey tone mosaics

Grey colours will tend to give the water **either bluish or greenish tones.**

Tenderá a tener unos **colores grisáceos con notas o bien azuladas o bien verdosas.**

Inox, Cuarzo, Stone, 2560-A
2522-B, Sarsen

Elles auront tendance à avoir des couleurs grisâtres avec des **notes bleuâtres ou verdâtres.**



2585-B 50 - Niebla Collection

Green mosaics

Perfect for **green tones** that blends in with the surrounding landscape.

Indicados para conseguir **colores de agua verde** que den continuidad a entornos vegetales.

Bali Stone, Green Pearl, Grasshopper, Tomahawk, Esmeralda, Cuprite

Recommandées pour obtenir des **couleurs d'eau vertes** qui donnent une continuité à un cadre entouré de végétation.



Coral 25 - Iridescent Collection

Light blue-green mosaics

These tones make the pool water a **light turquoise blue.**

Tienden a dar un color **azul claro turquesa** a la piscina.

Azur - Sky, 2521-B, 2508-A, 2518-B, 2529-B, Coral

Tienden a dar un color **azul claro turquesa** a la piscina.



Lava 25 - Metal Collection

Iridescent black and dark green tones

These tones give the water the **colour of a river or high mountain lake.**

Dan a la piscina un estilo de **color de agua natural de río o lago de alta montaña.**

Lava, Phyllite, Ebano, Capricorn, Jade, 2502-A

Ils donnent à la piscine un style de **couleur d'eau naturelle d'une rivière ou d'un lac de haute montagne.**

Finishing System

The correct installation guarantee

La garantía de una correcta instalación

La garantie d'une installation correcte

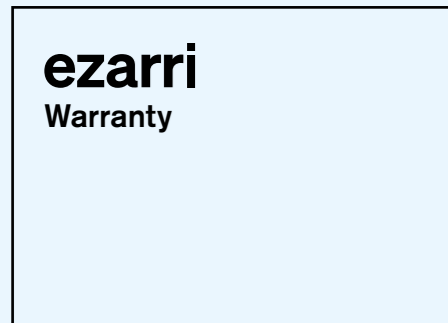

Warranty on Mosaics

Ezarri guarantees that its glass mosaics are free from manufacturing defects. Terms and conditions at Ezarri.com.

Ezarri, garantiza al comprador que sus mosaicos de vidrio están libres de defectos de fabricación. Términos y condiciones en Ezarri.com.

Ezarri, garantit à l'acheteur que ses mosaïques de verre sont exemptes de défauts de fabrication. Termes et conditions sur Ezarri.com.

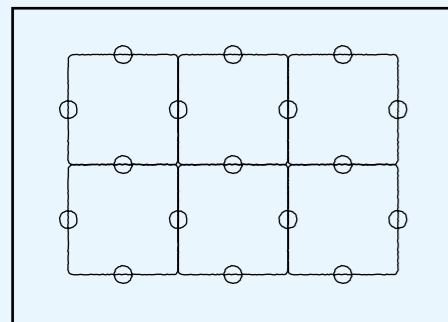

JointPoint®

The panelling system is the most important factor in the quality of the mosaic.

El sistema de empanelado es el factor más importante y de mayor influencia en la calidad del mosaico.

Le système de fixation est le facteur le plus important et ayant la plus grande influence sur la qualité de la mosaïque.

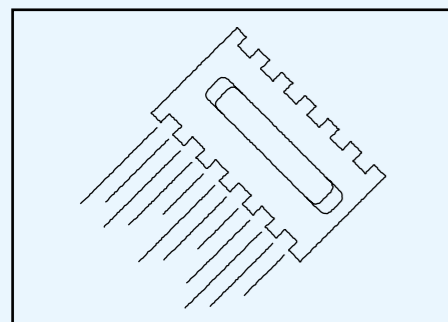

Adhesives&Joints

The right installation products are essential, preferably from the same manufacturer.

Los productos de instalación deben ser los adecuados, preferiblemente de un mismo fabricante.

Les produits d'installation doivent être les corrects, de préférence du même fabricant.

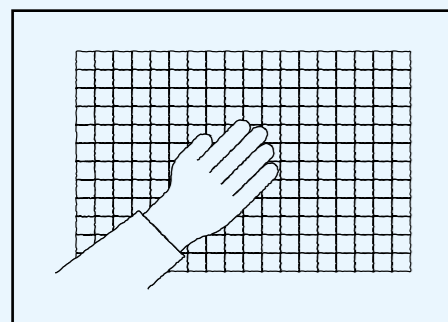

Specialised workforce

A professional installer, using Ezarri mosaic and the right installation products will ensure a successful long-lasting project.

Un instalador profesional, que utilice el mosaico Ezarri con los productos de instalación adecuados, obtendrá un resultado exitoso y duradero.

Un installateur professionnel, utilisant la mosaïque Ezarri avec les bons produits d'installation, obtiendra un résultat réussi et durable.

Warranty

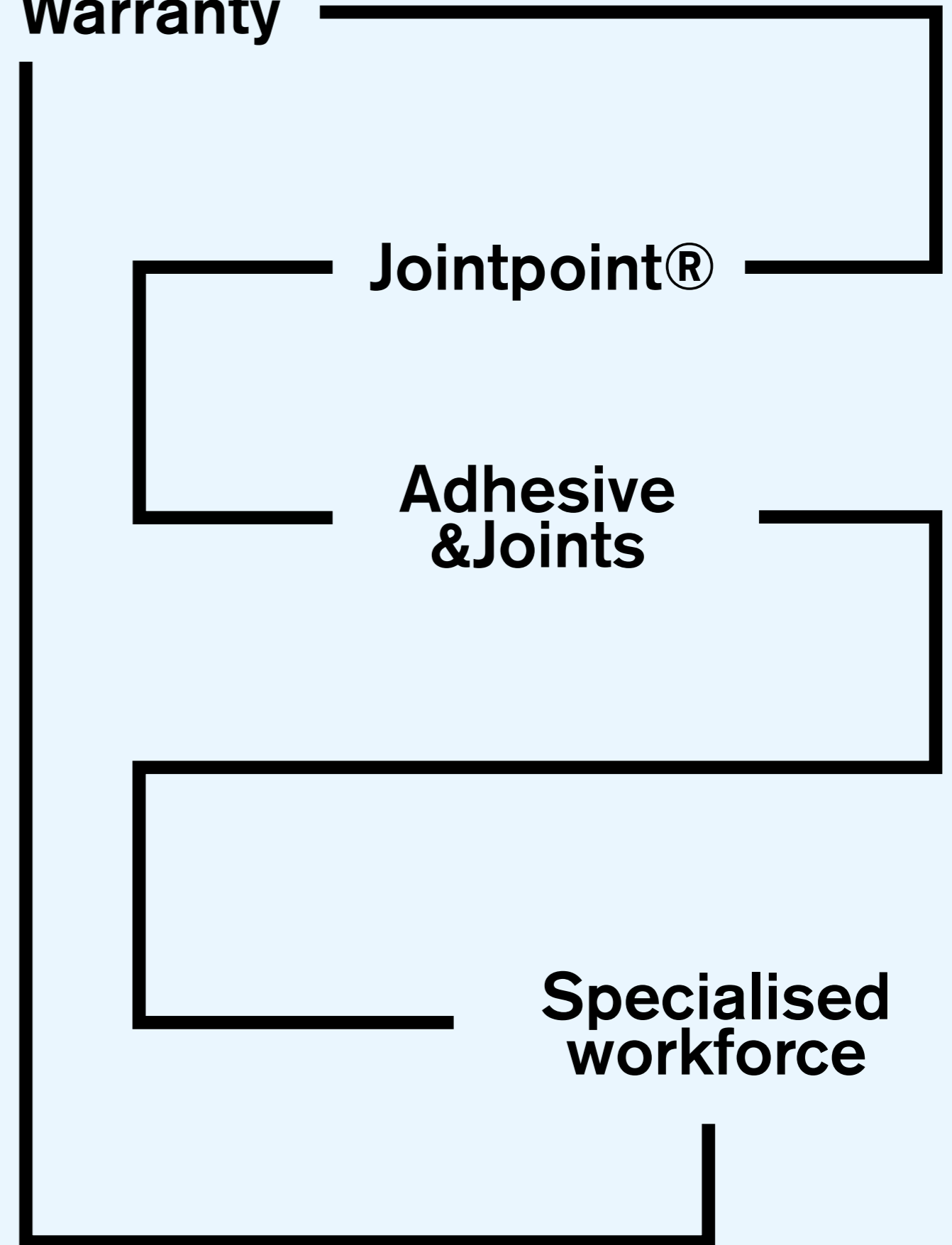

Jointpoint®

Adhesive & Joints

Specialised workforce

Pool



Phyllite 25 - Zen Collection

Our pool projects

Nuestros proyectos pool

Notre pool projecte

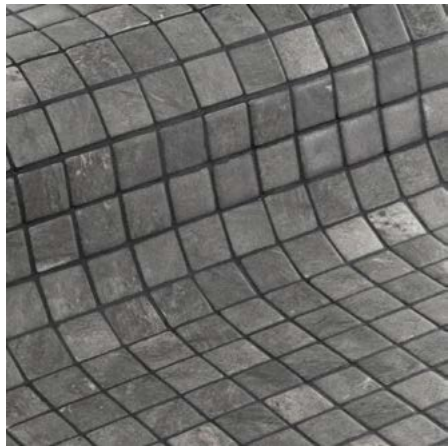

Phyllite 25
Zen Collection

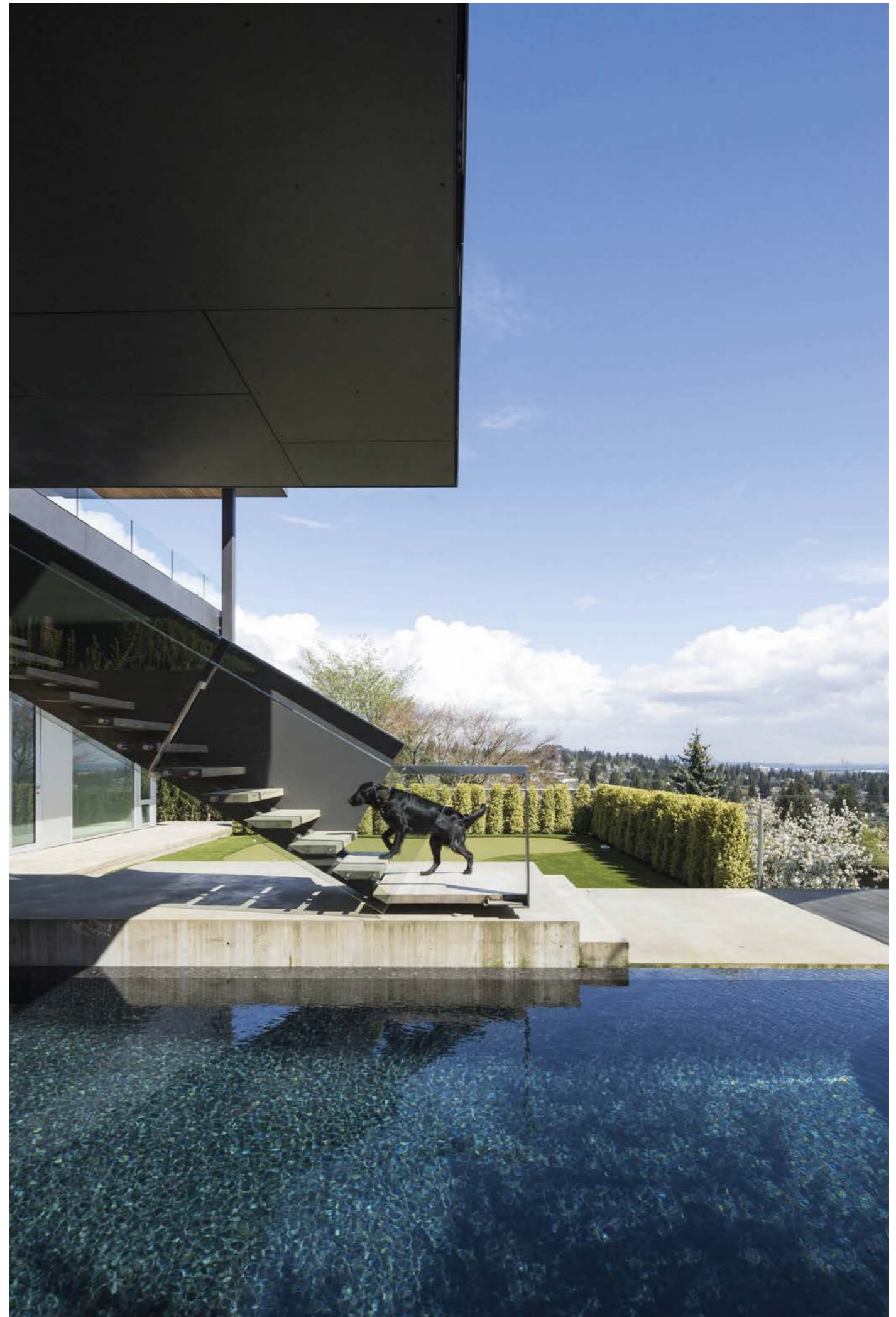



Bali Stone 25
Zen Collection

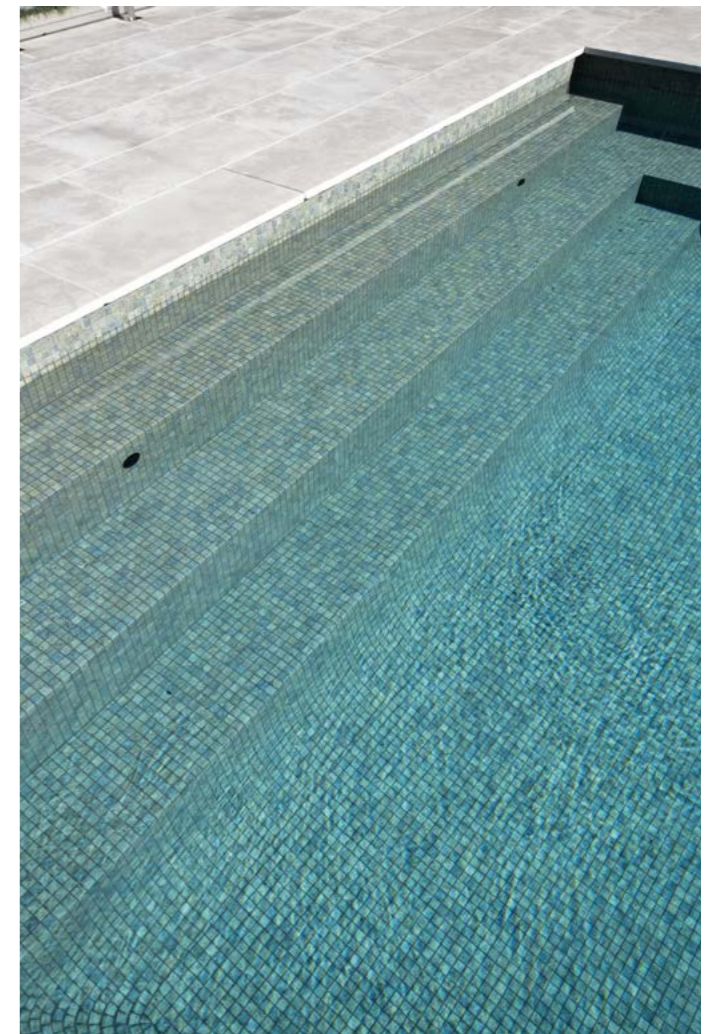



Alexander 25
Cocktail Collection

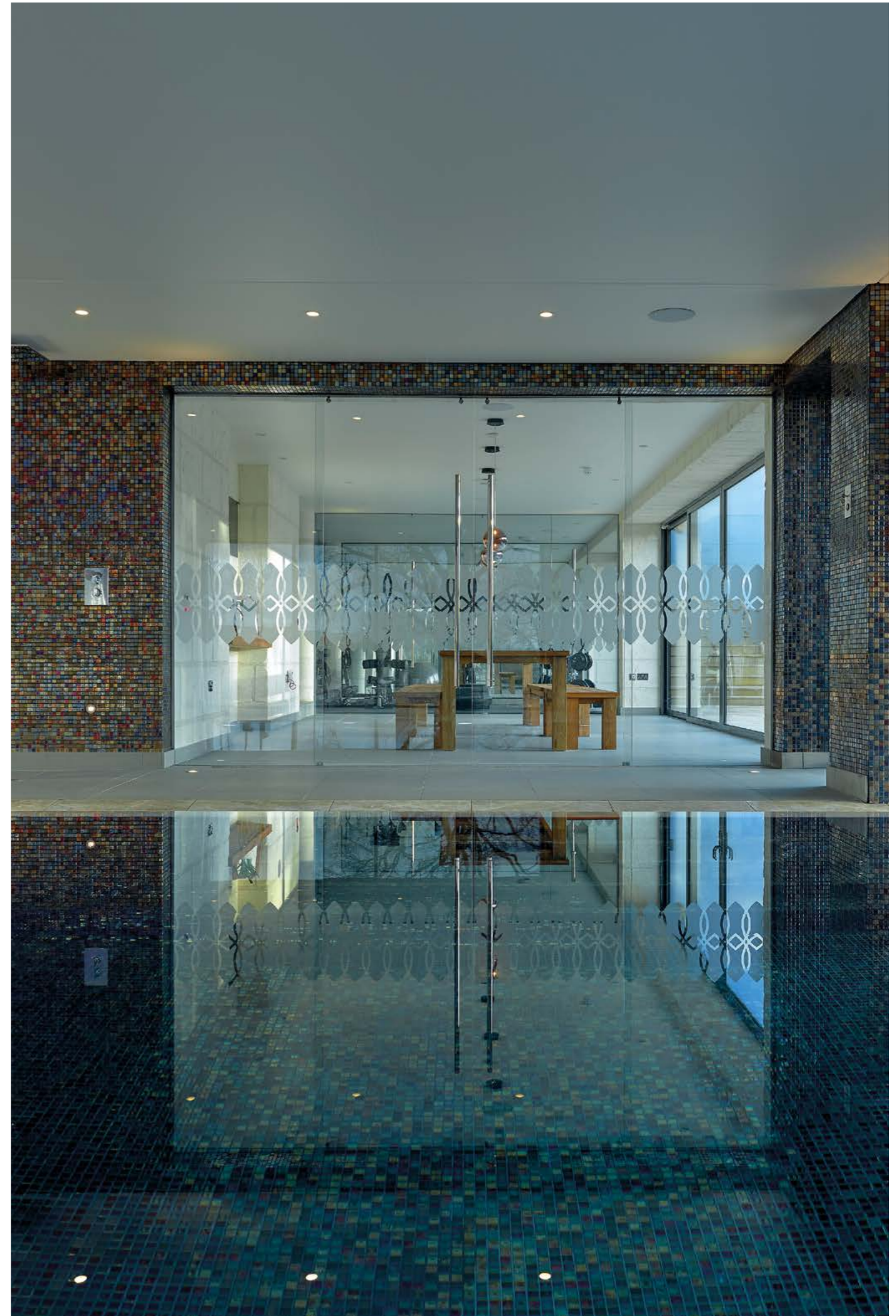
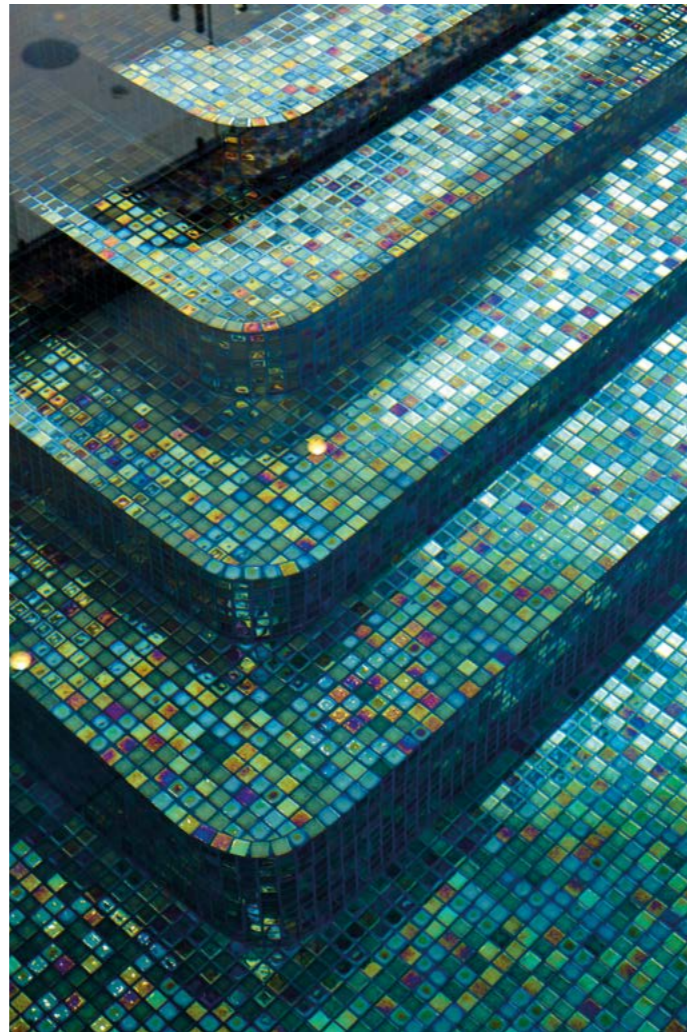

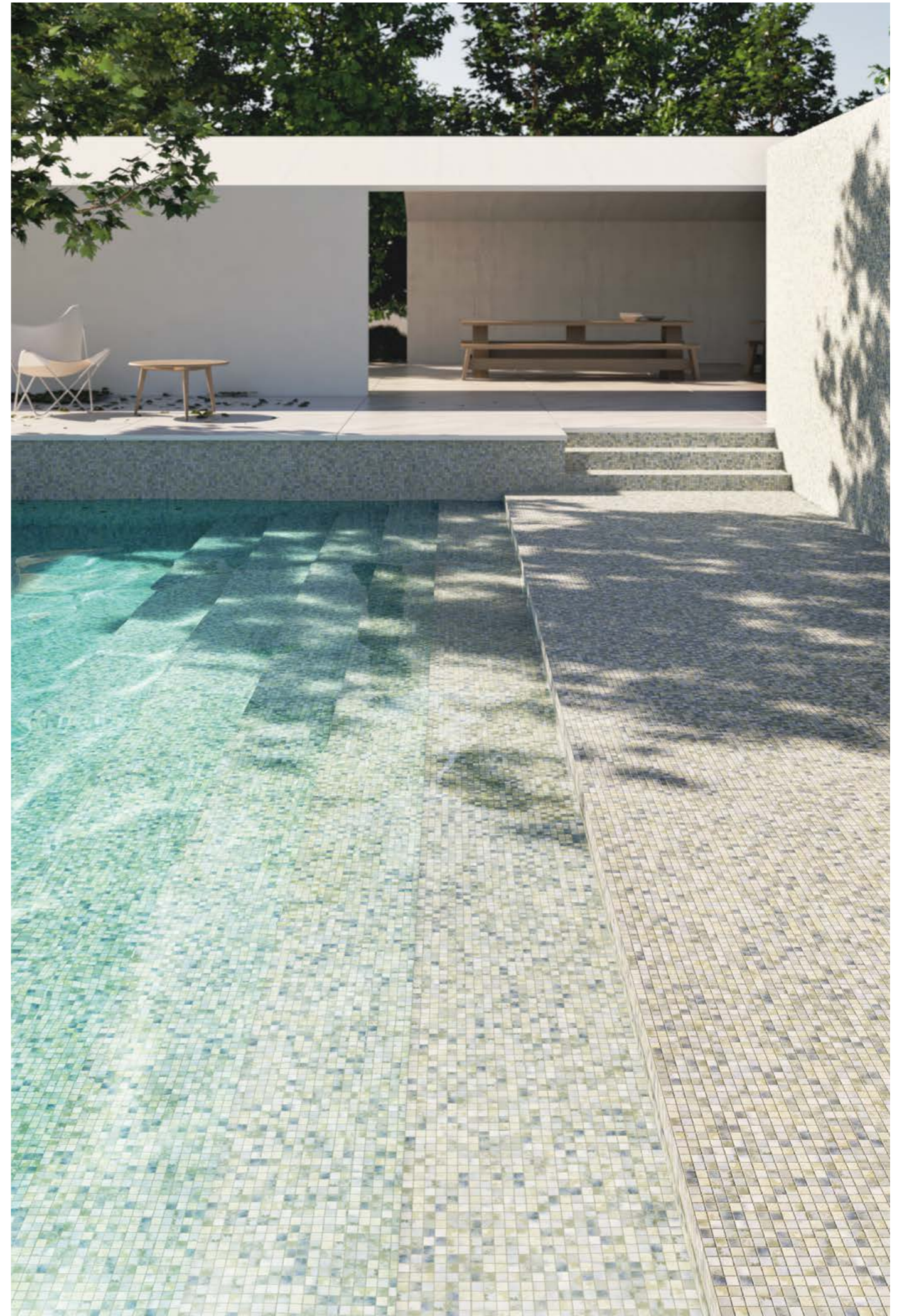
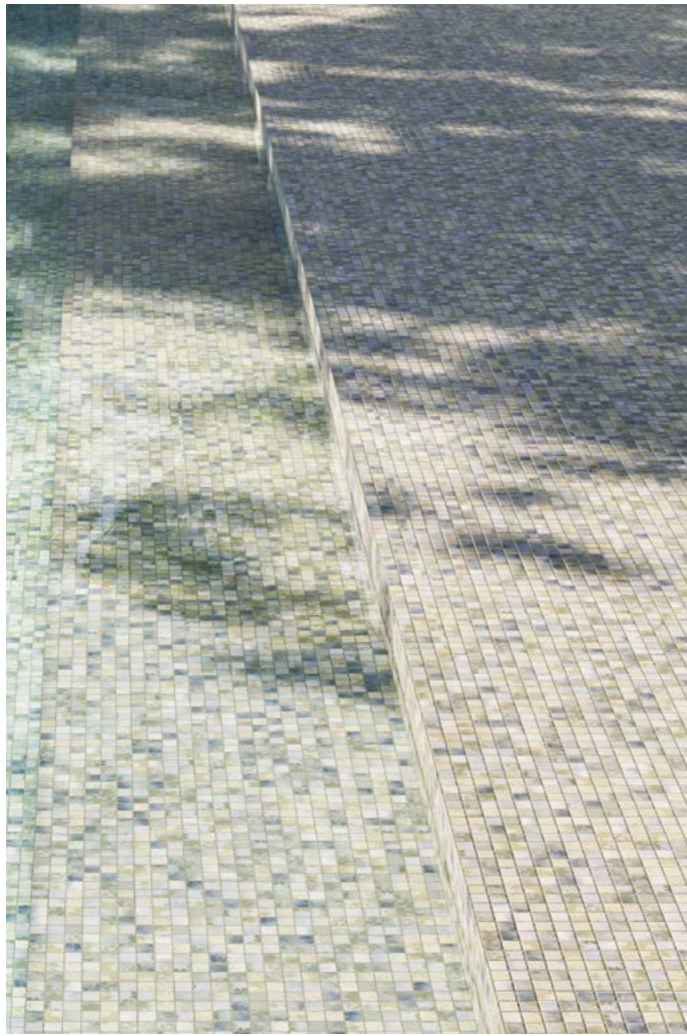

Fluid 25
Aquarelle Collection





Ash 25
Zen Collection

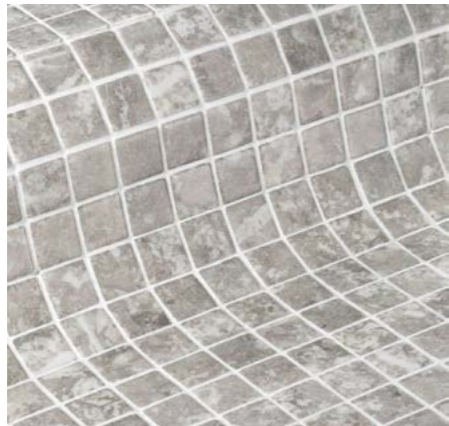

Phyllite 25
Zen Collection

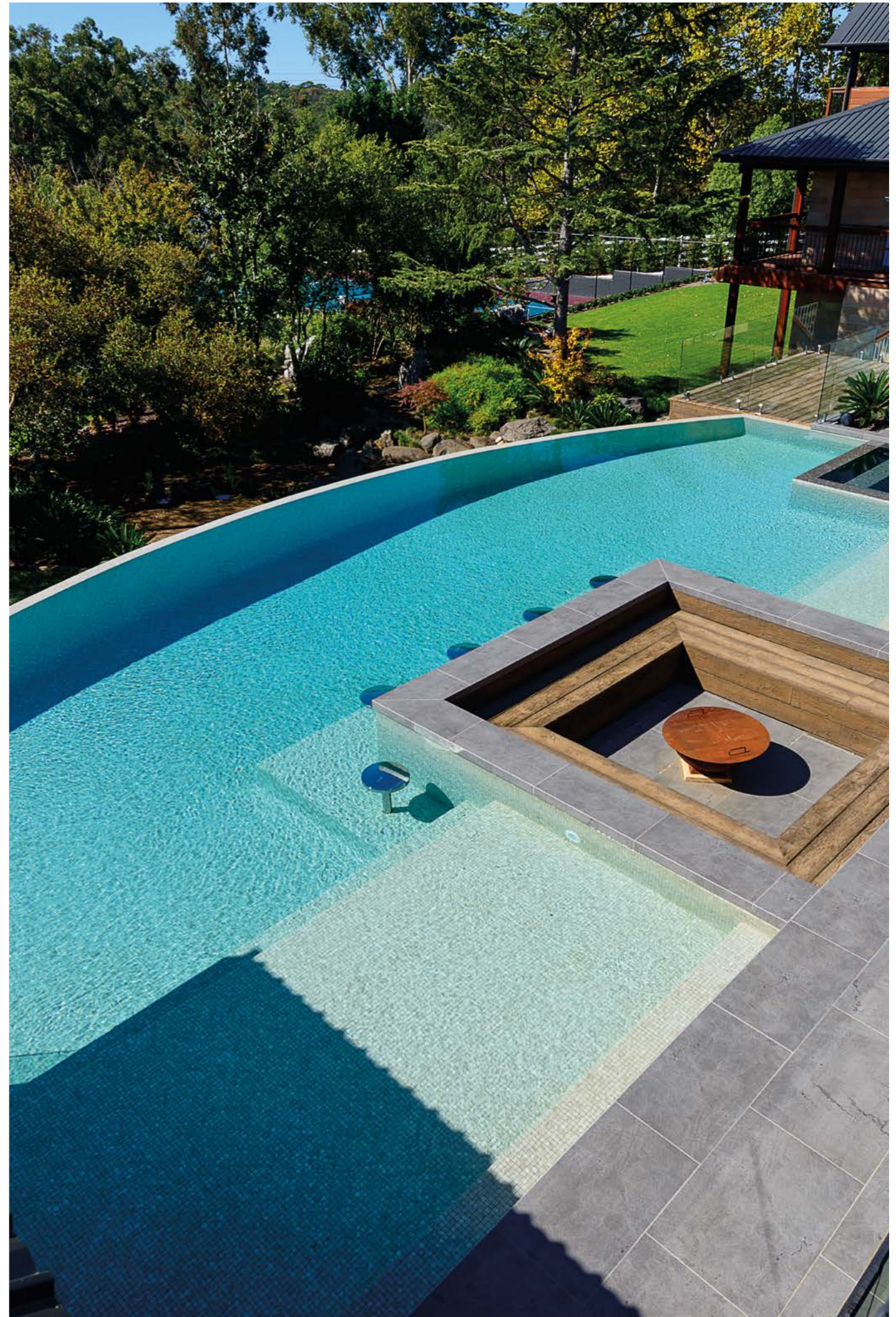
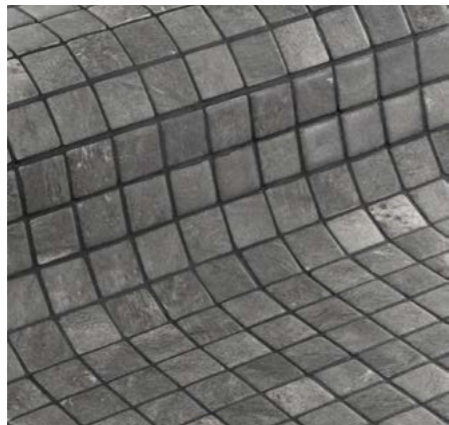

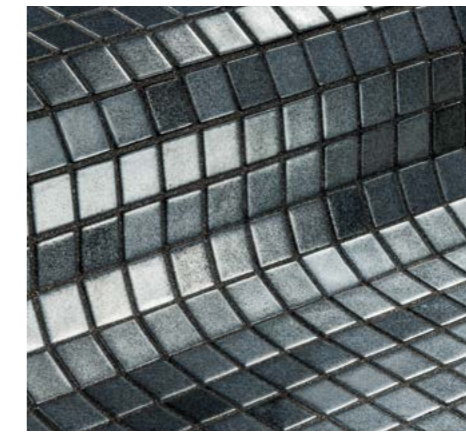

Capricorn 25
Space Collection





Celestite 25
Gemma Collection

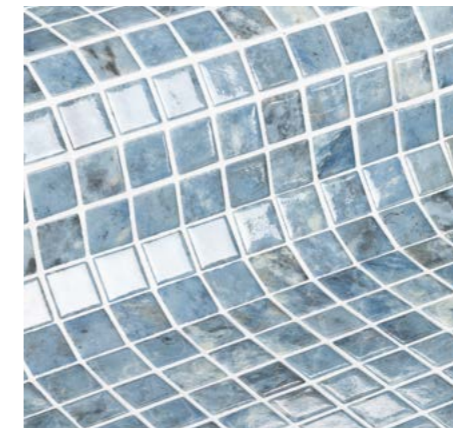

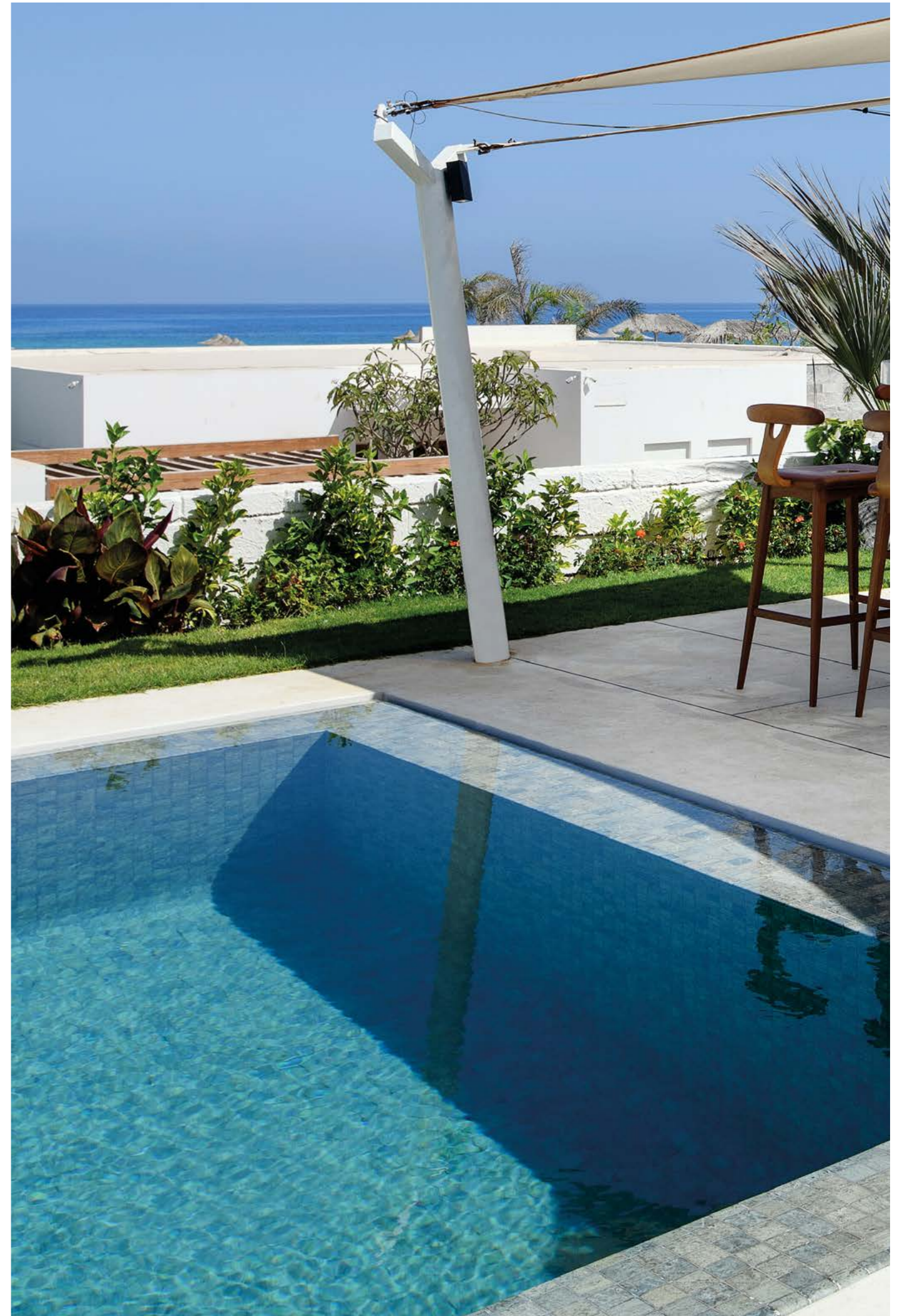

Bali Stone 50
Zen Collection

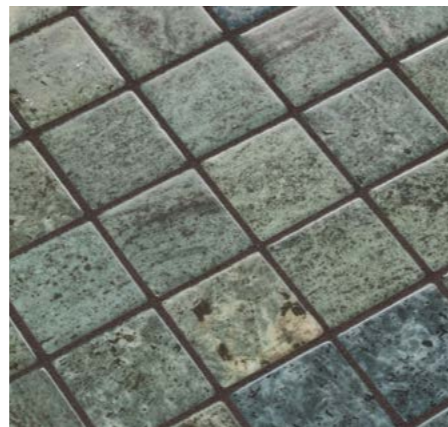



Tomahawk 25
Cocktail Collection

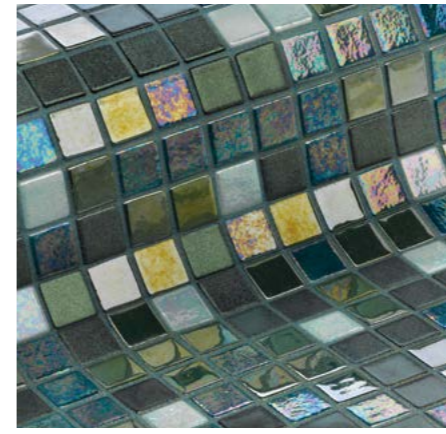



Nickel 25
Metal Collection





Cuarzo 25
Iridescent Collection

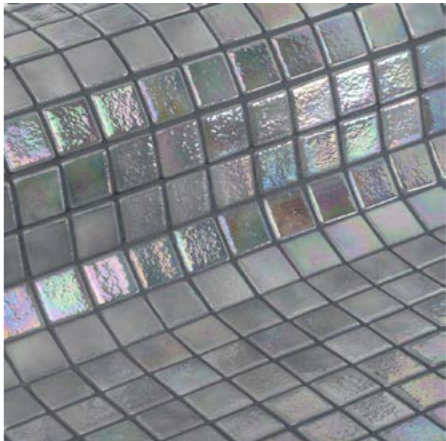

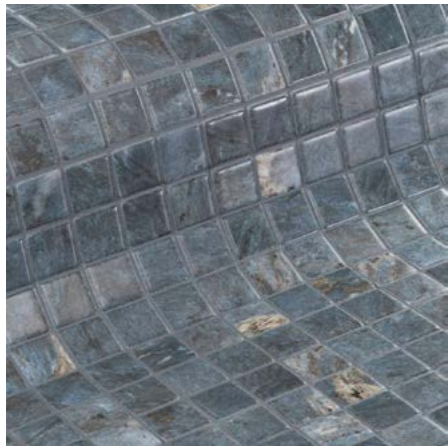

Dolerite 25
Zen Collection



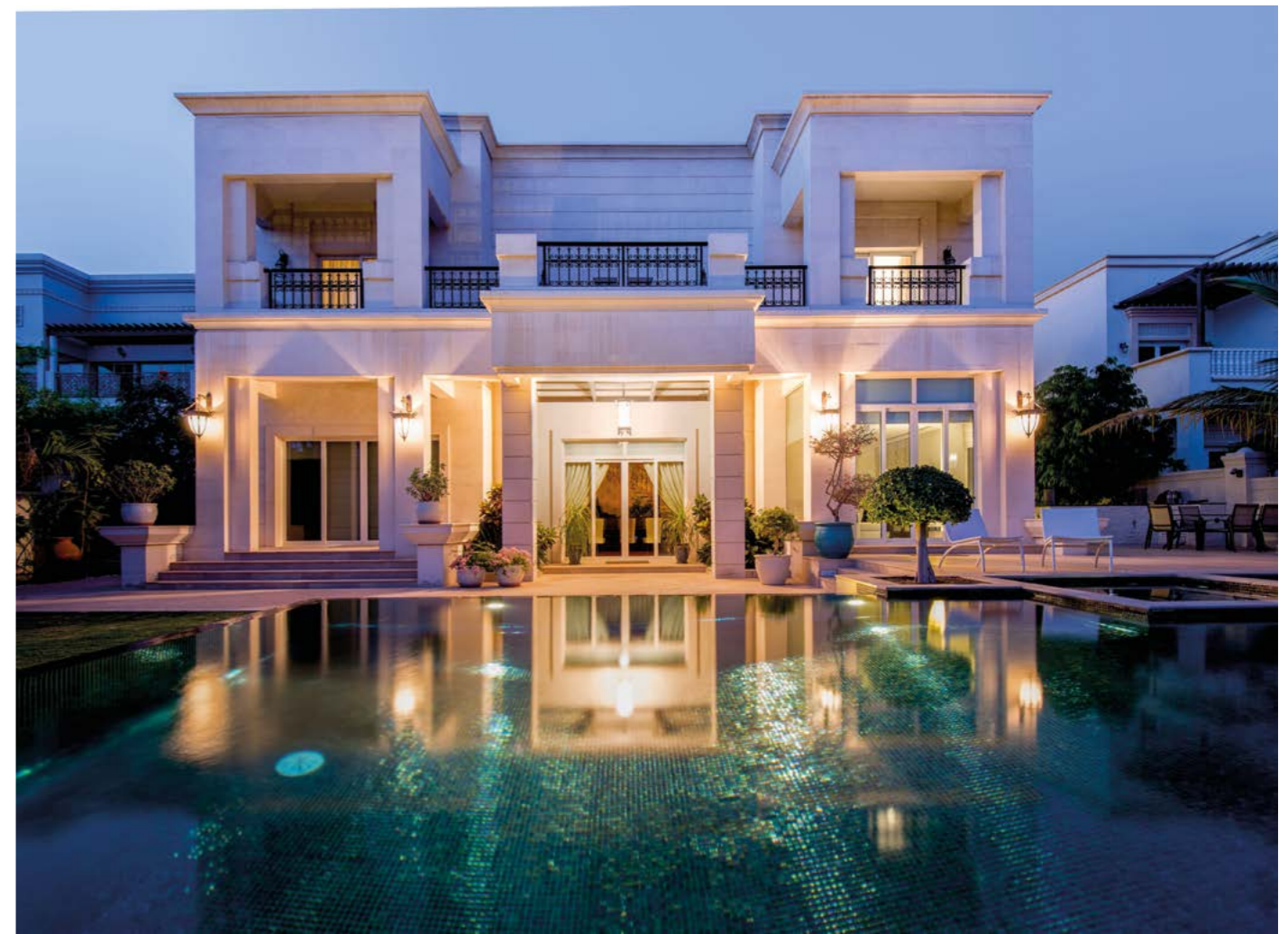

Ebano 25
Iridescent Collection

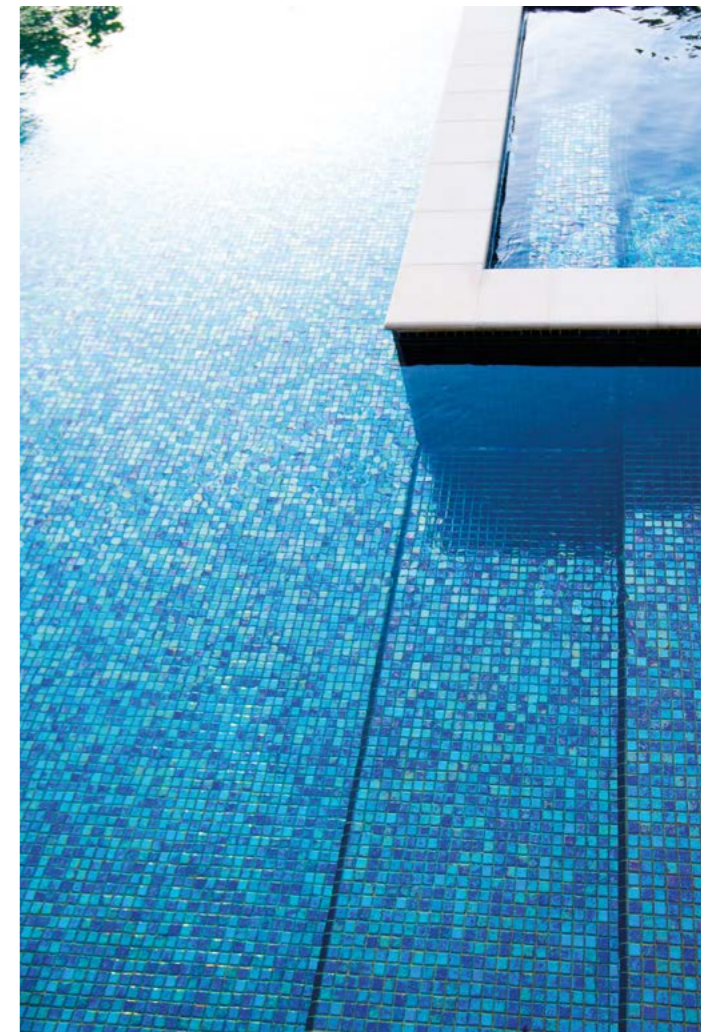
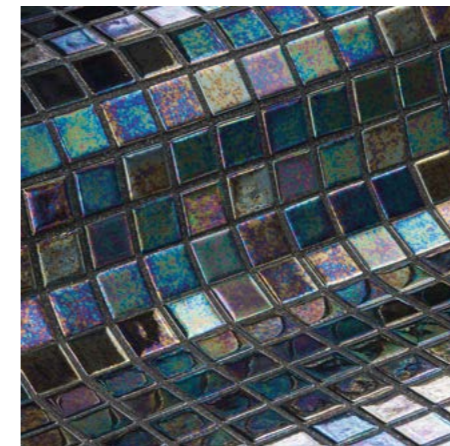



Argo 25
Fosfo Collection

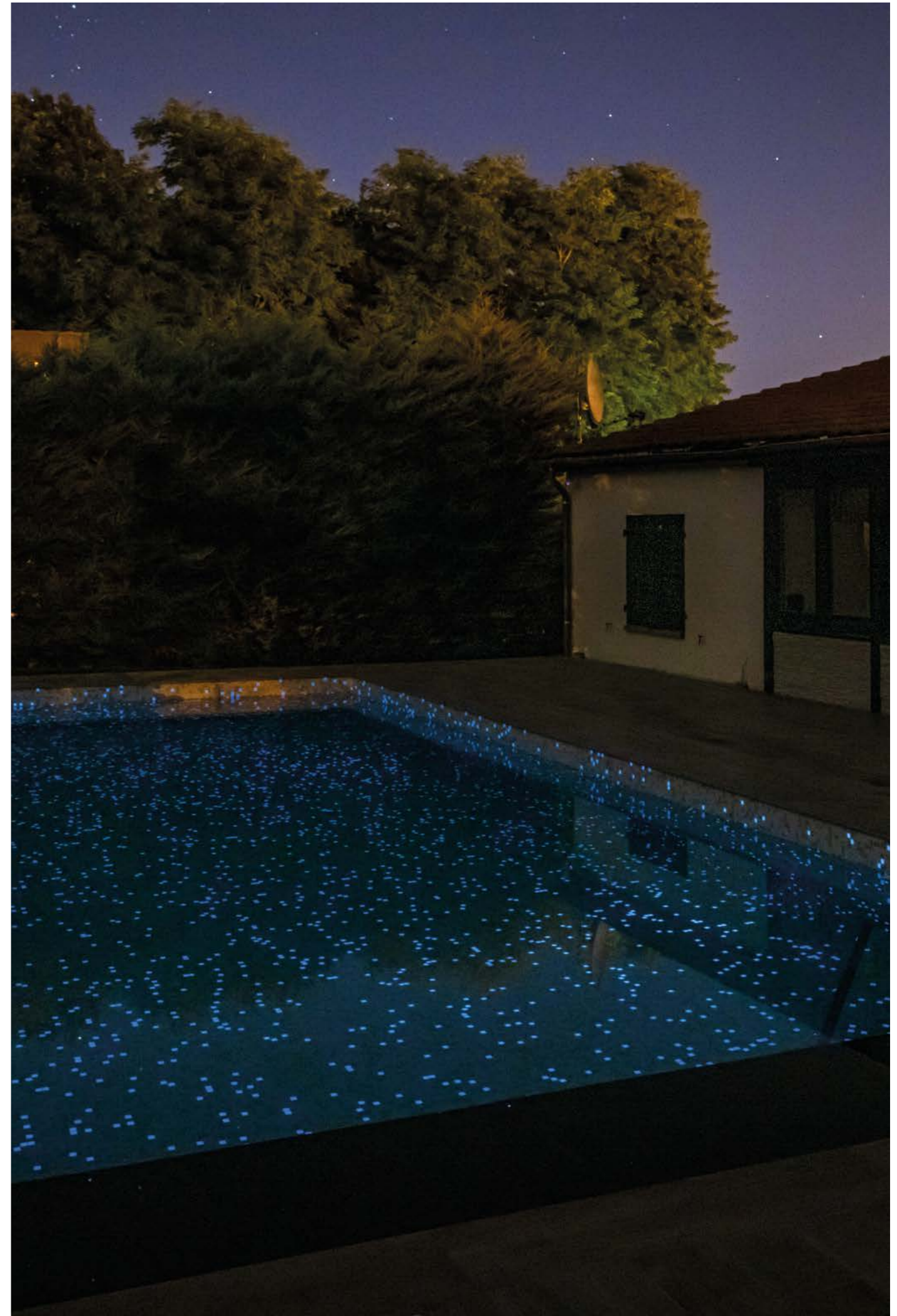
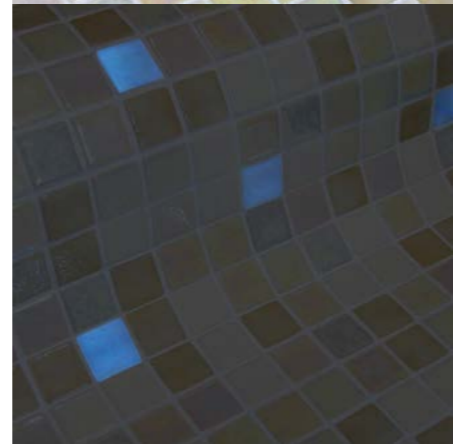



Inox 25
Metal Collection

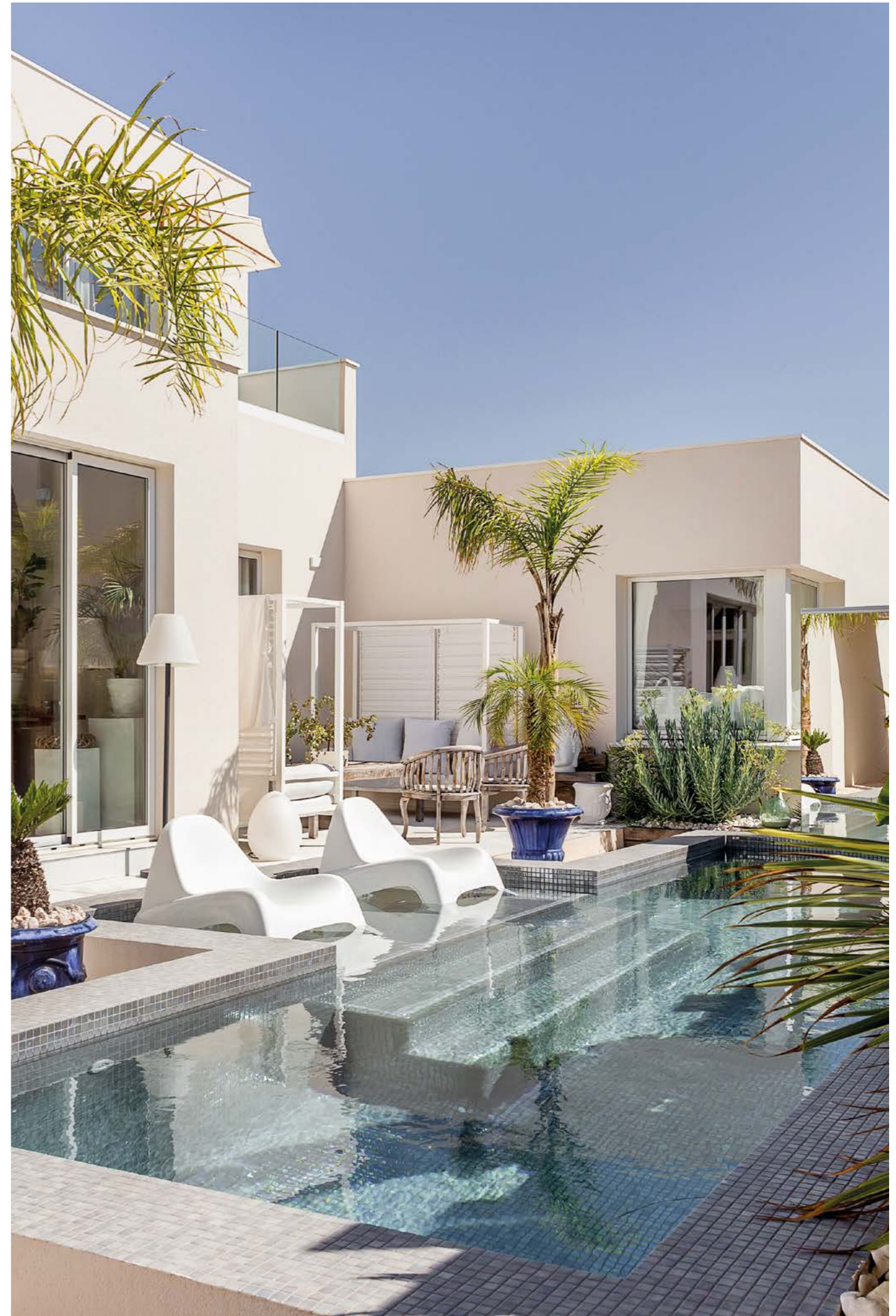



Green Pearl 25
Iridescent Collection

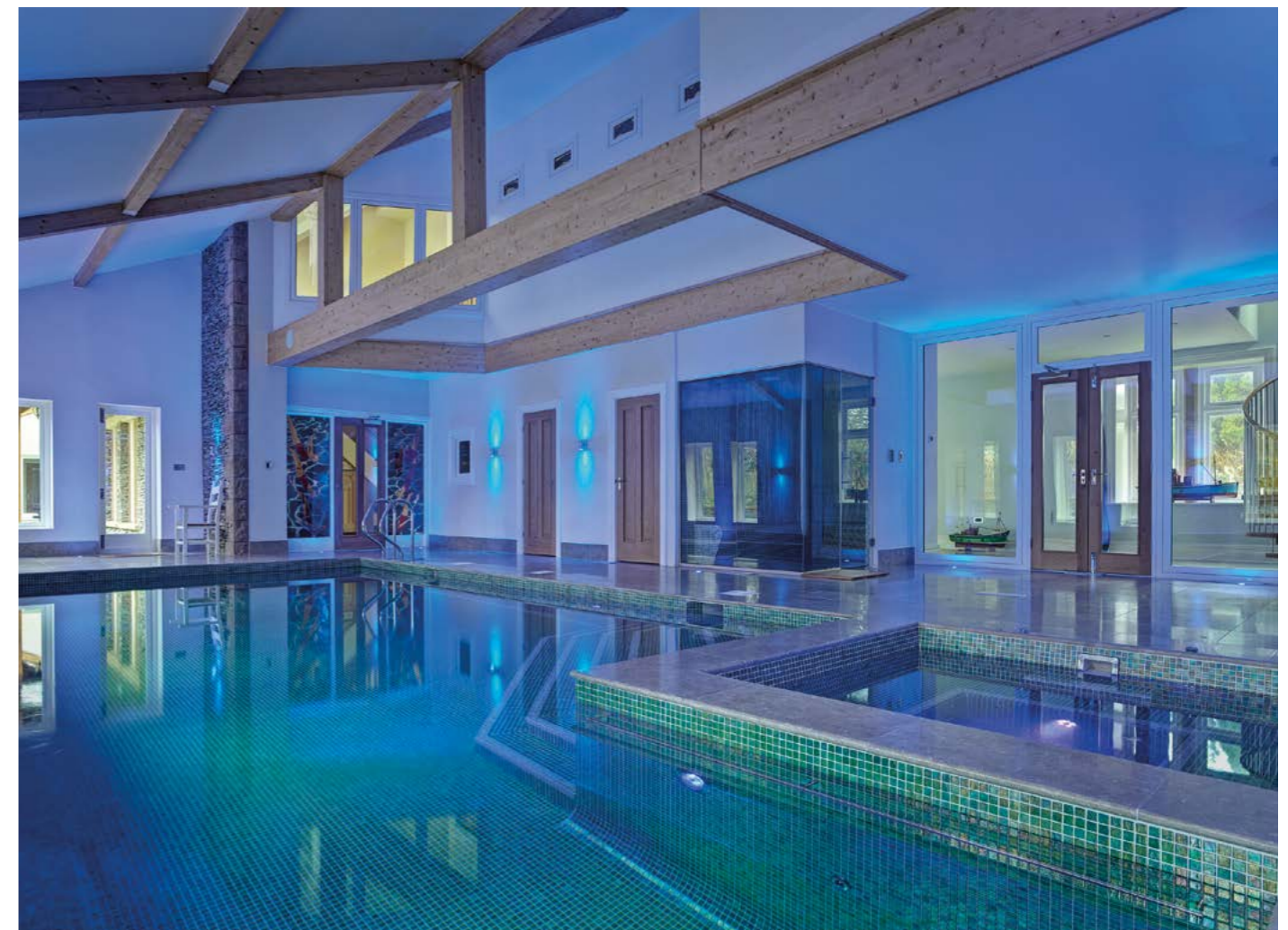
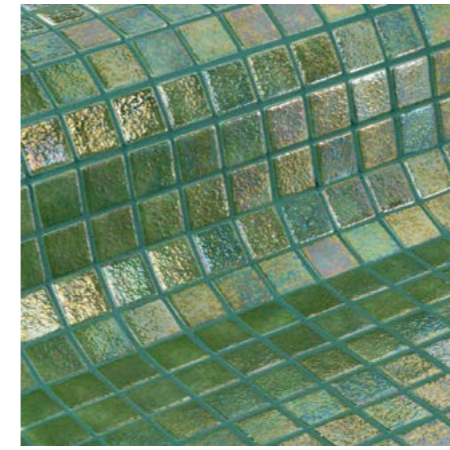



Tigrato 25
Zen Collection

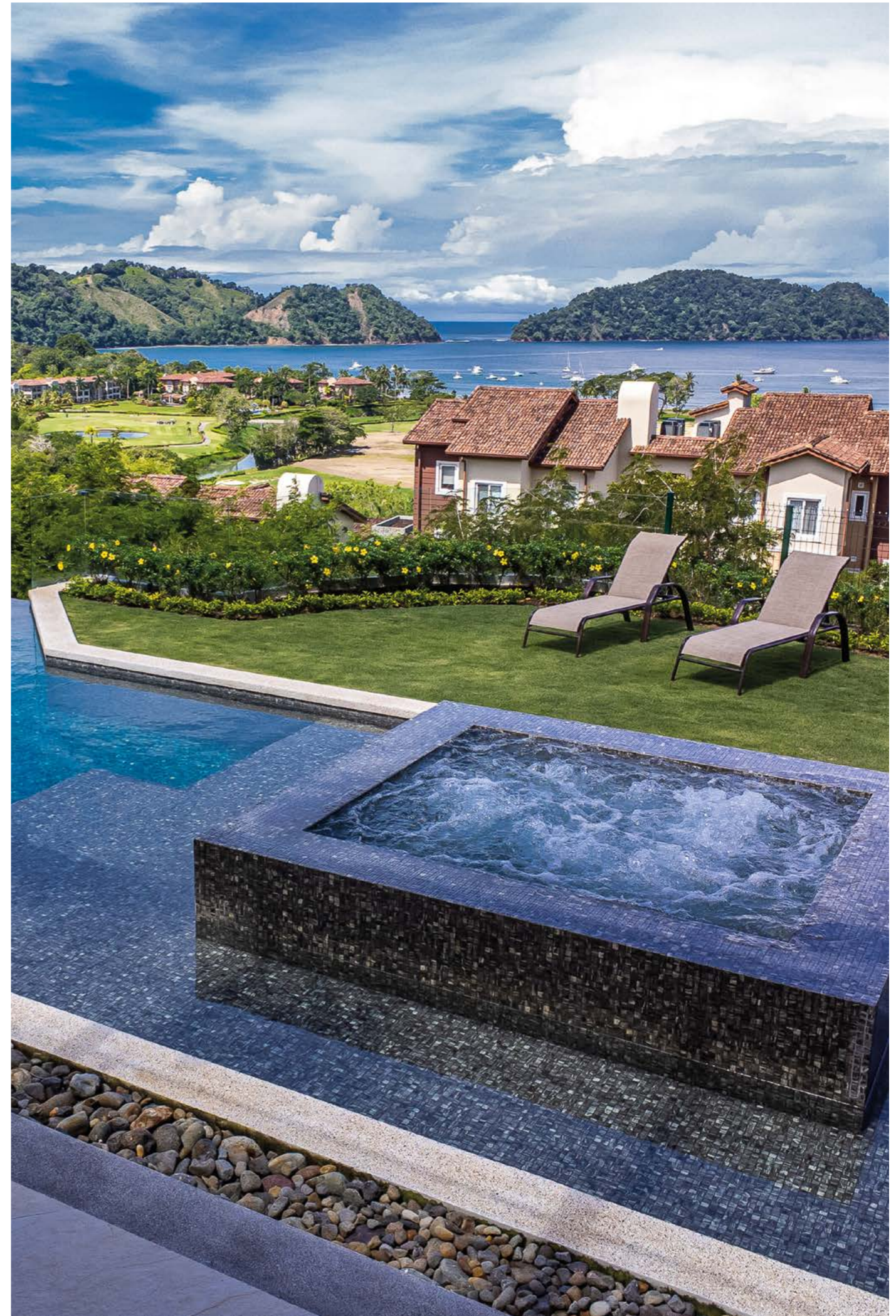
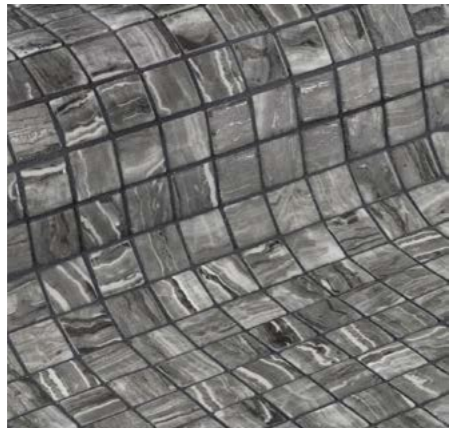

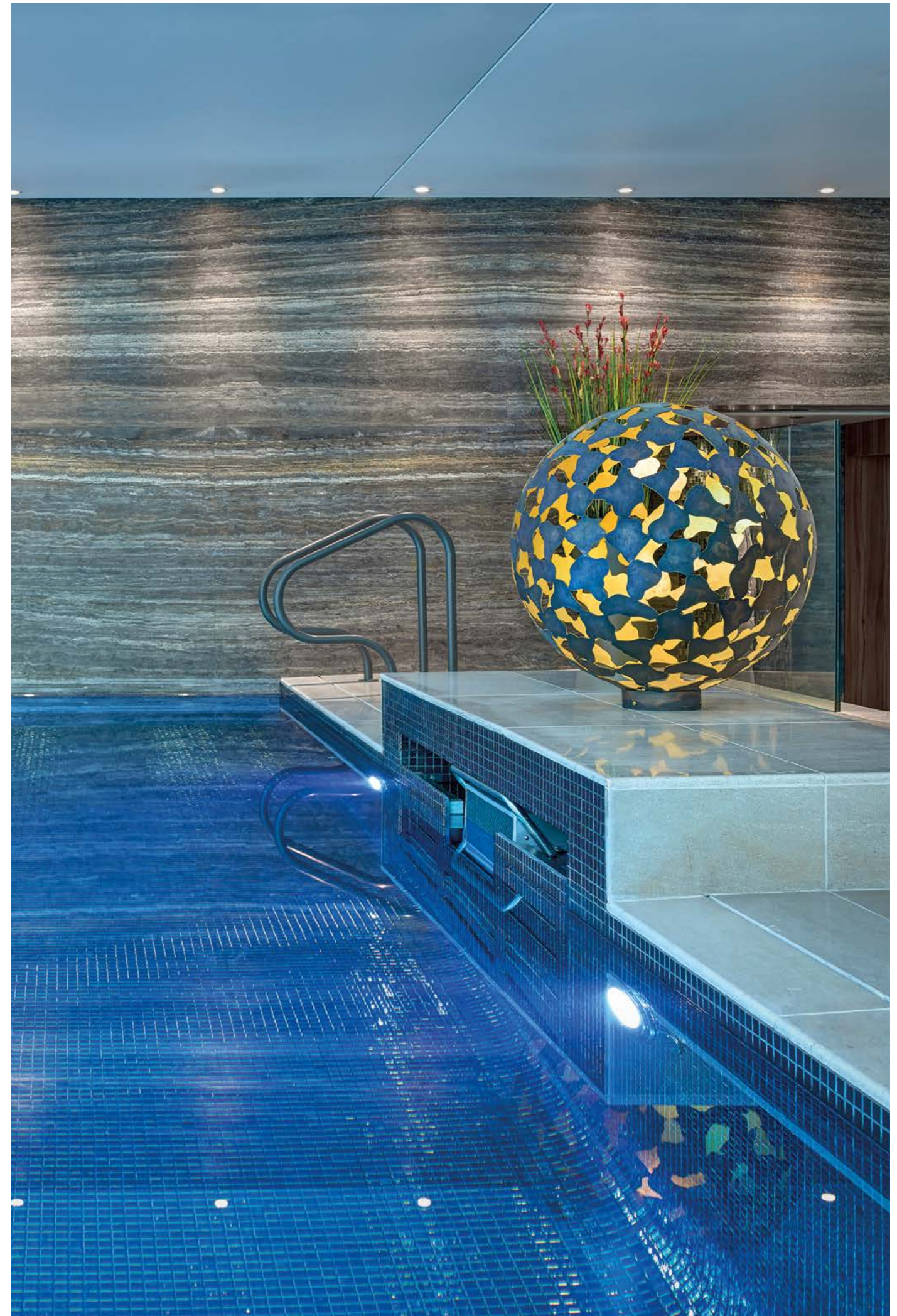

Lava 25
Metal Collection



Ocean 25
Iridescent Collection

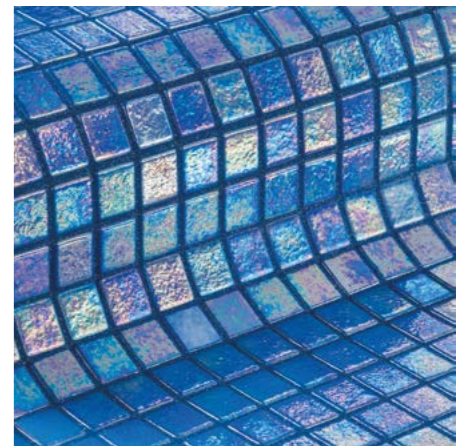

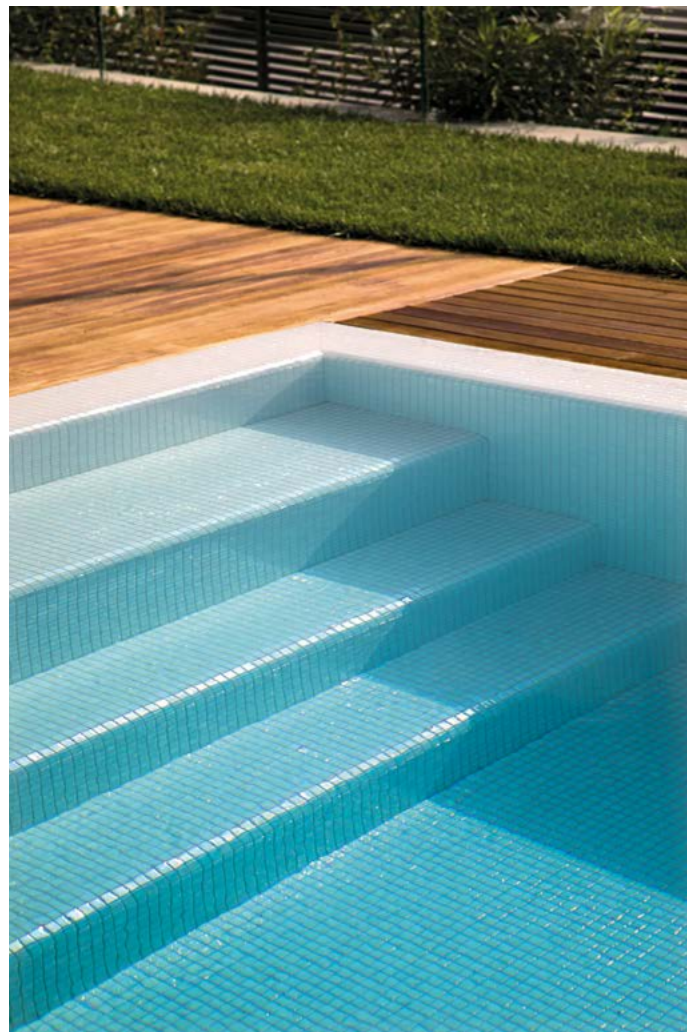

Perla 25
Iridescent Collection

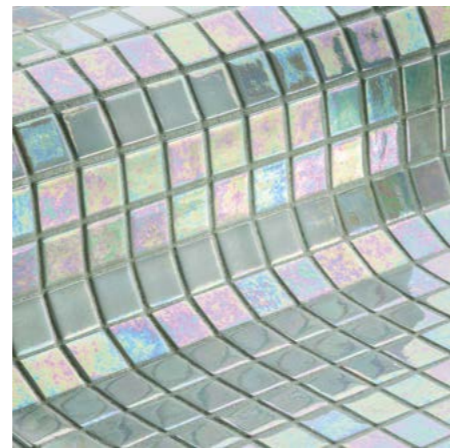



Sarsen 25
Zen Collection

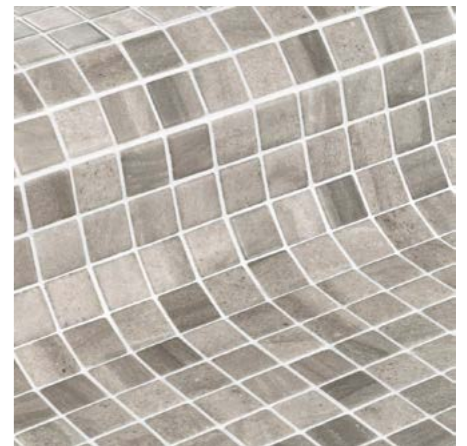



Taurus 25
Space Collection

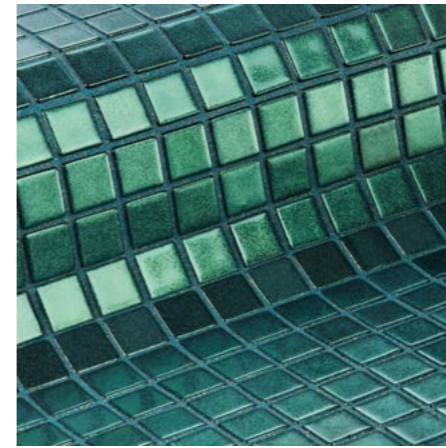



Travertino 25
Zen Collection



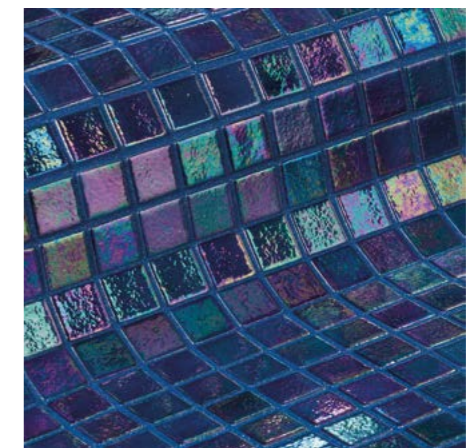
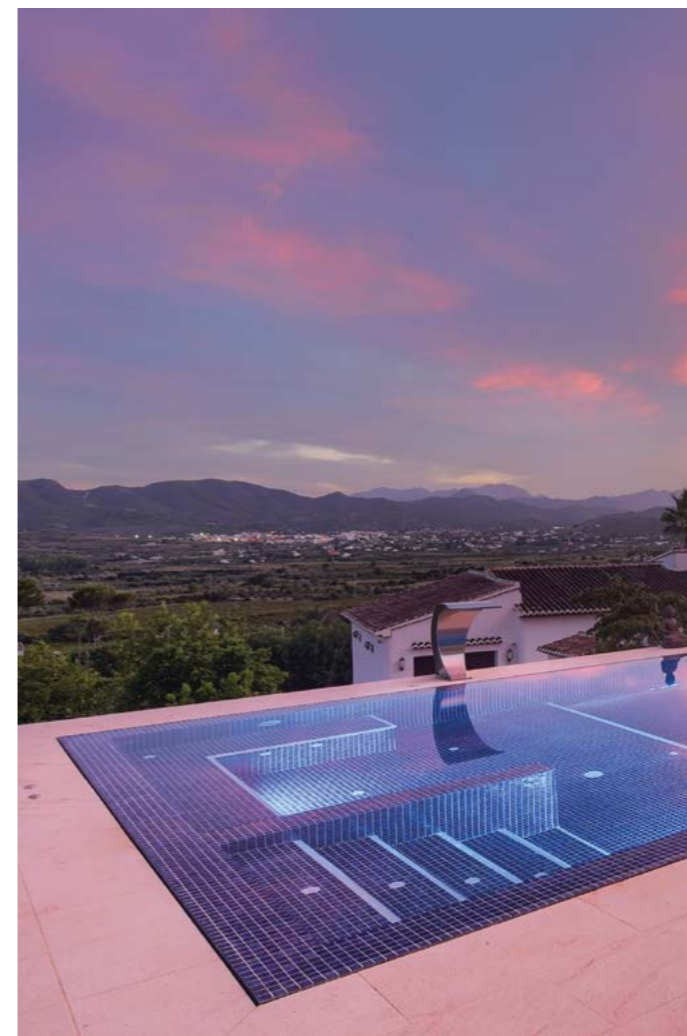
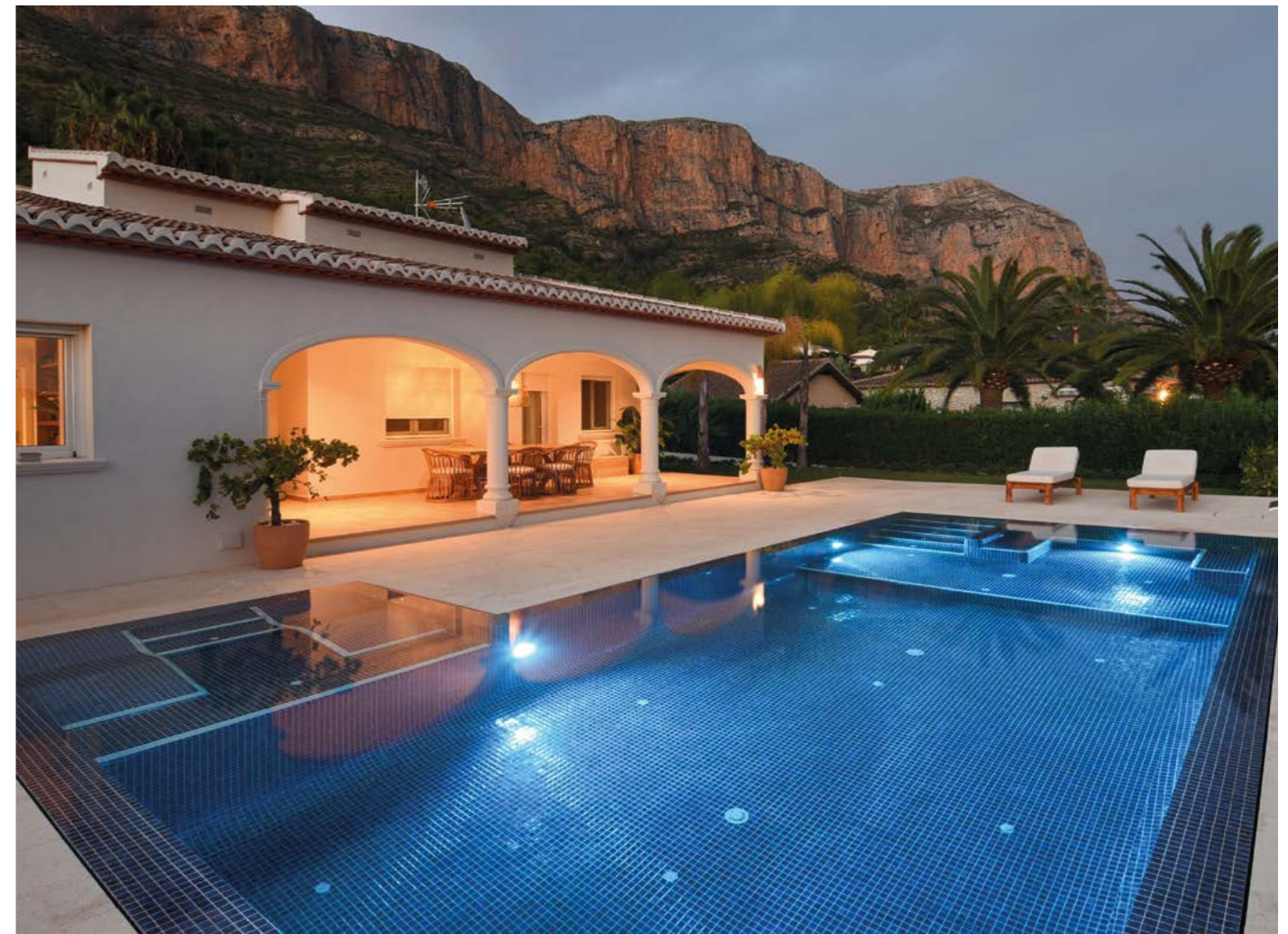

Zafiro 25
Iridescent Collection



2522-B 25
Niebla Collection

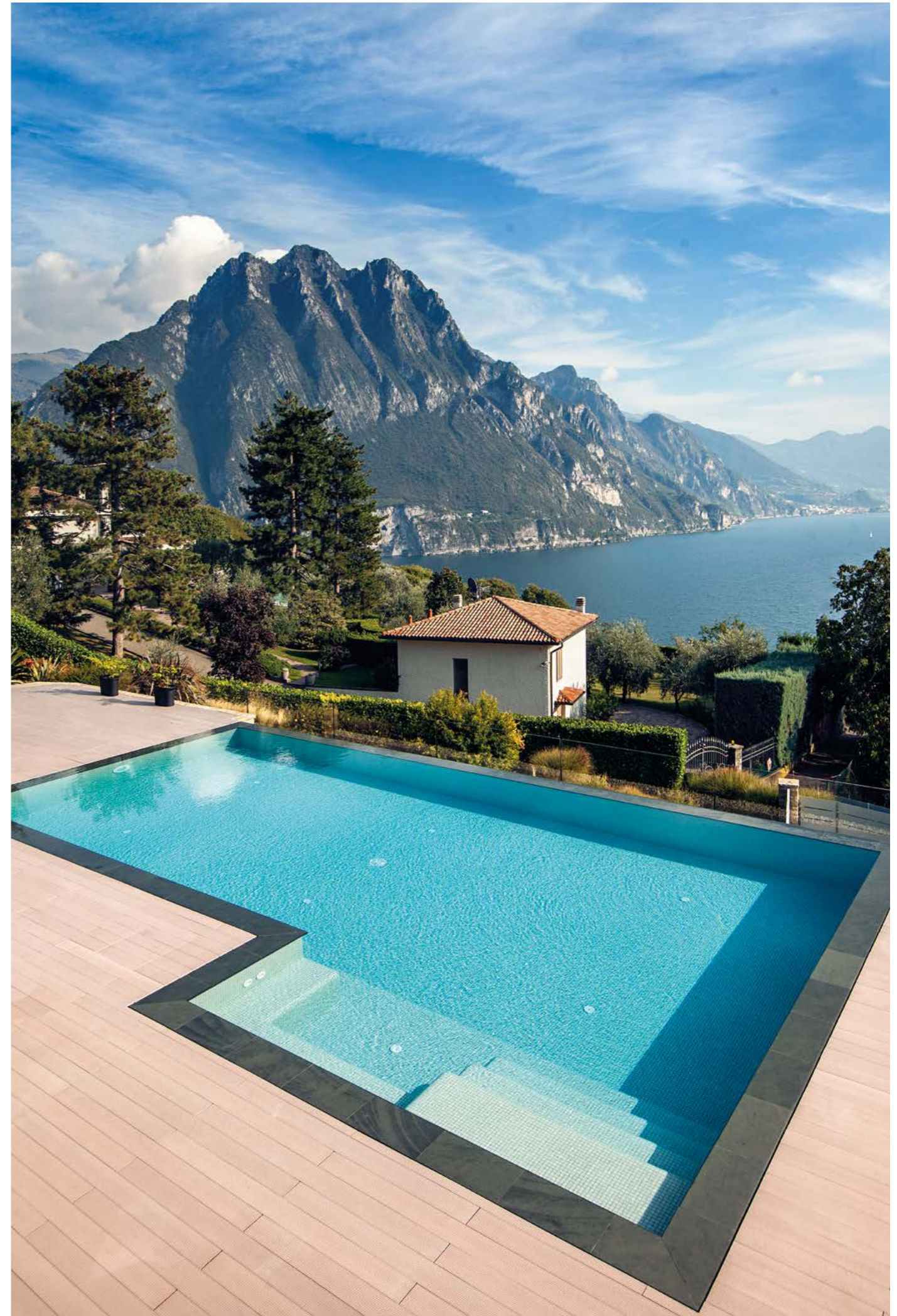
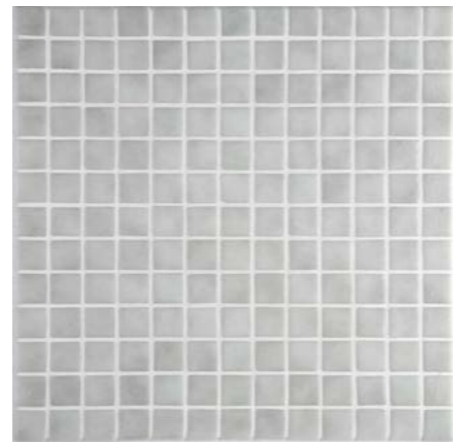

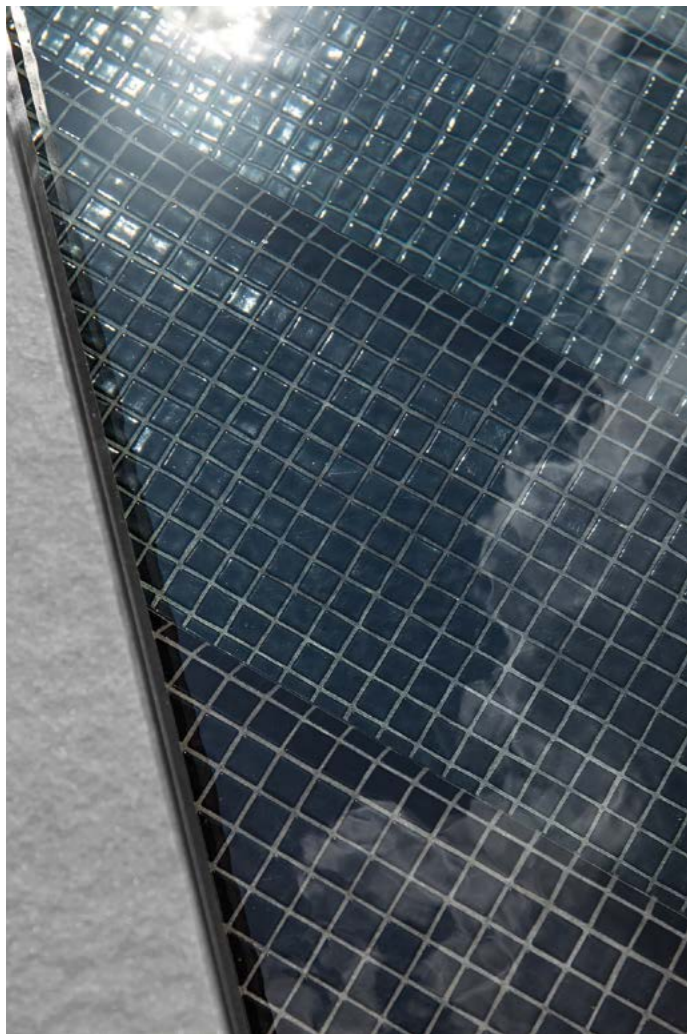

2530-D 25
Lisa Collection

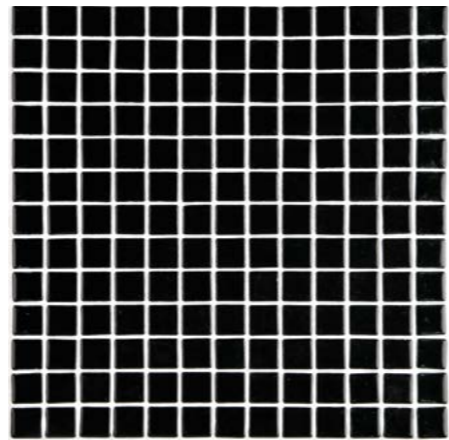



2505-A 25
Niebla Collection

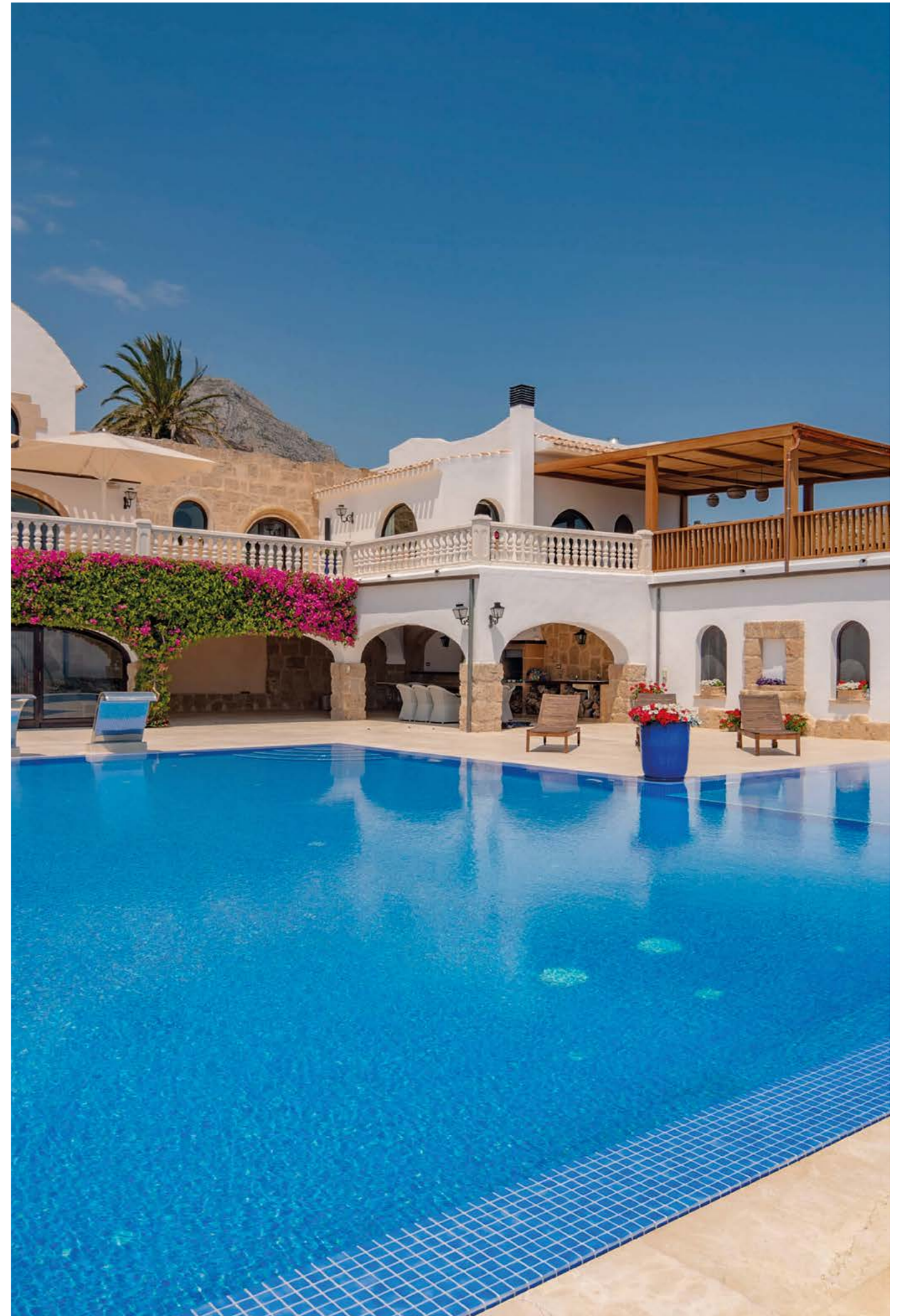



2560-A 25
Niebla Collection

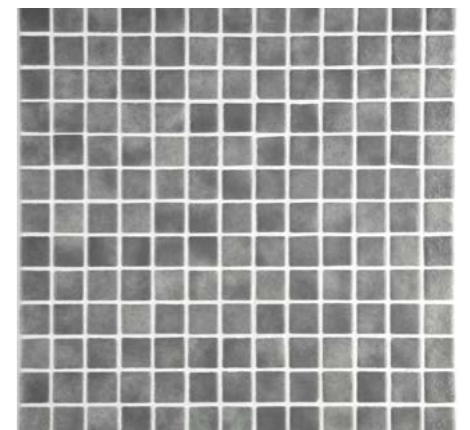

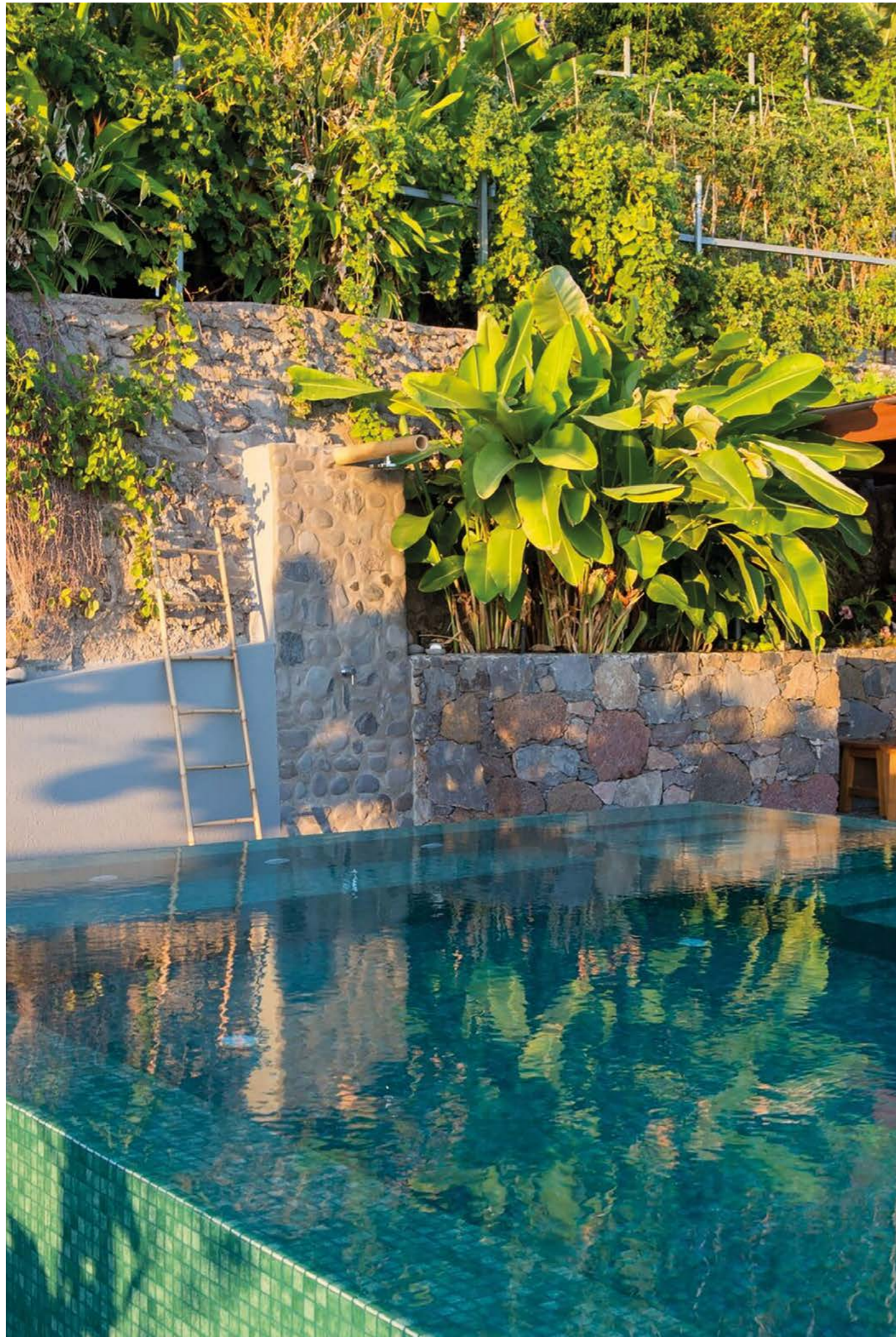

2586-B 25
Niebla Collection

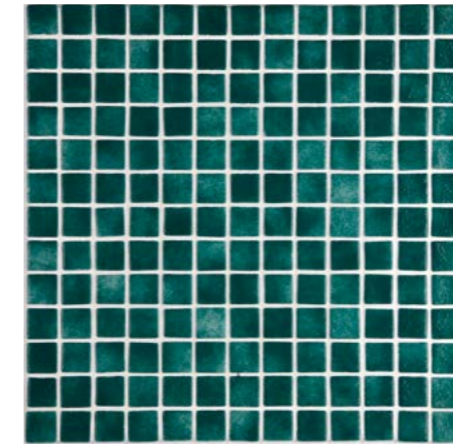



2543-D 36
Lisa Collection

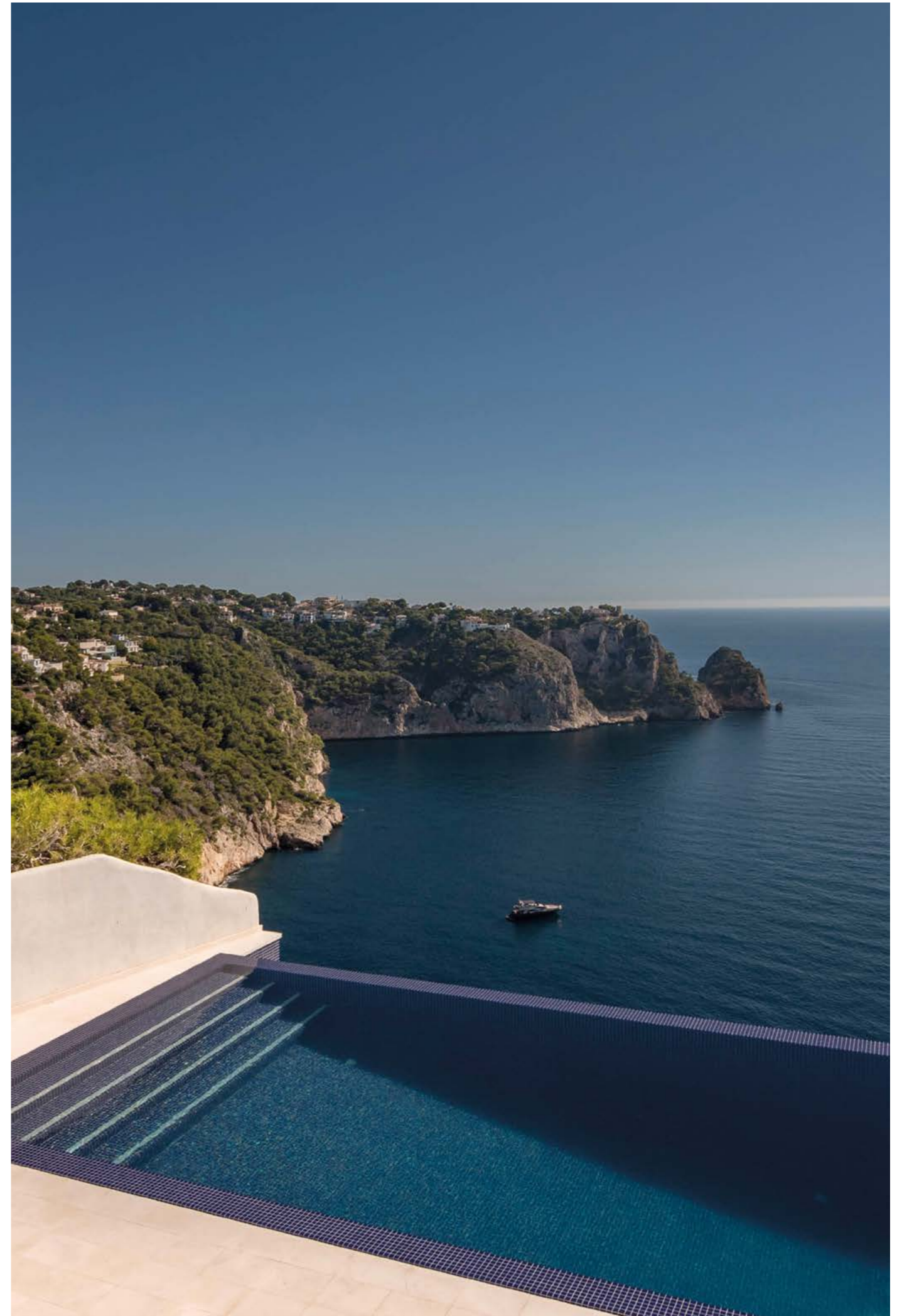
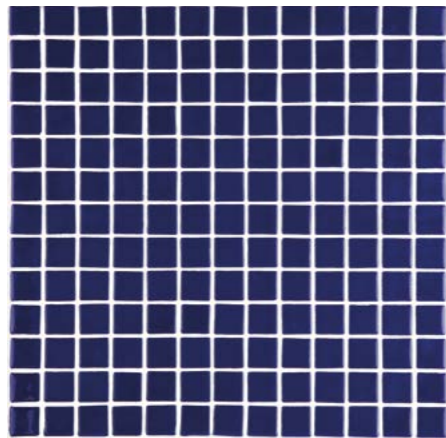



2585-B 50
Niebla Collection

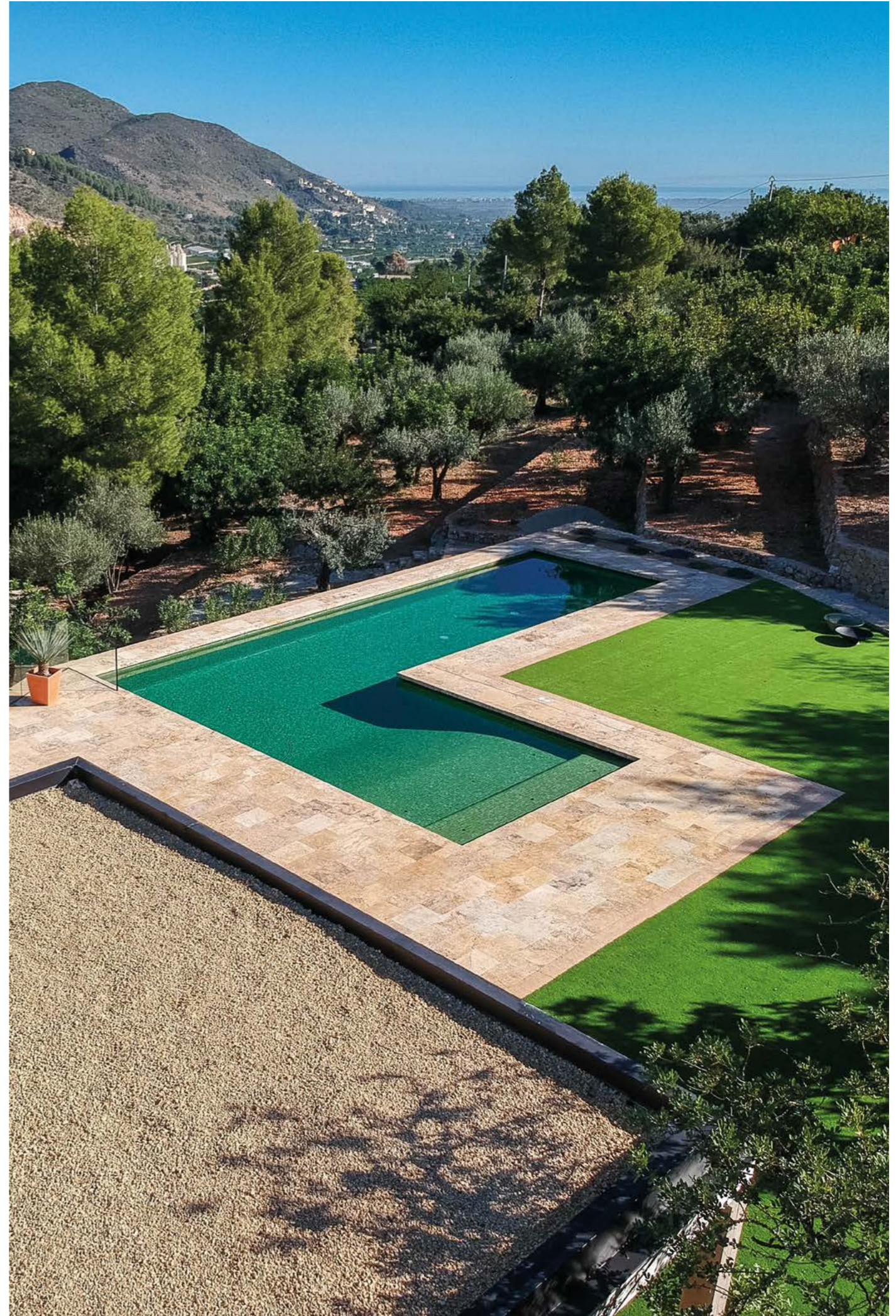

Home





Carrara 25
Zen Collection

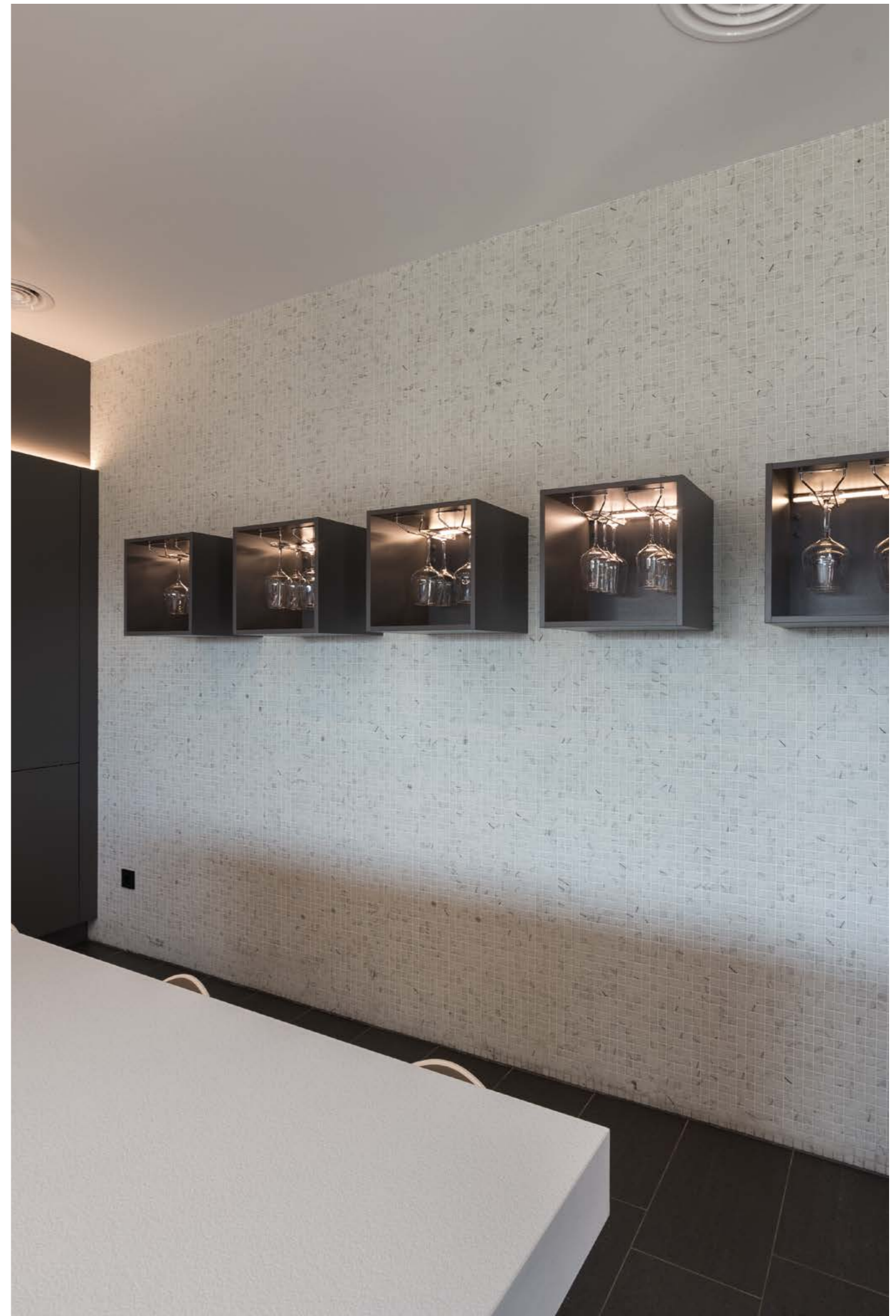

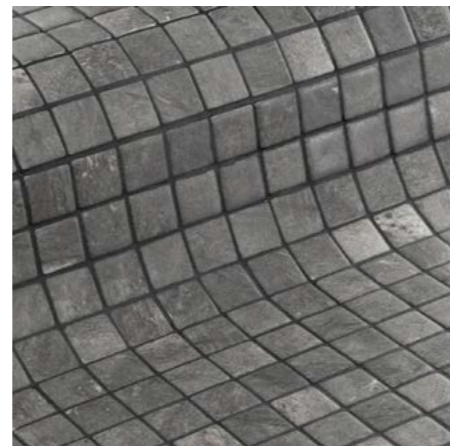
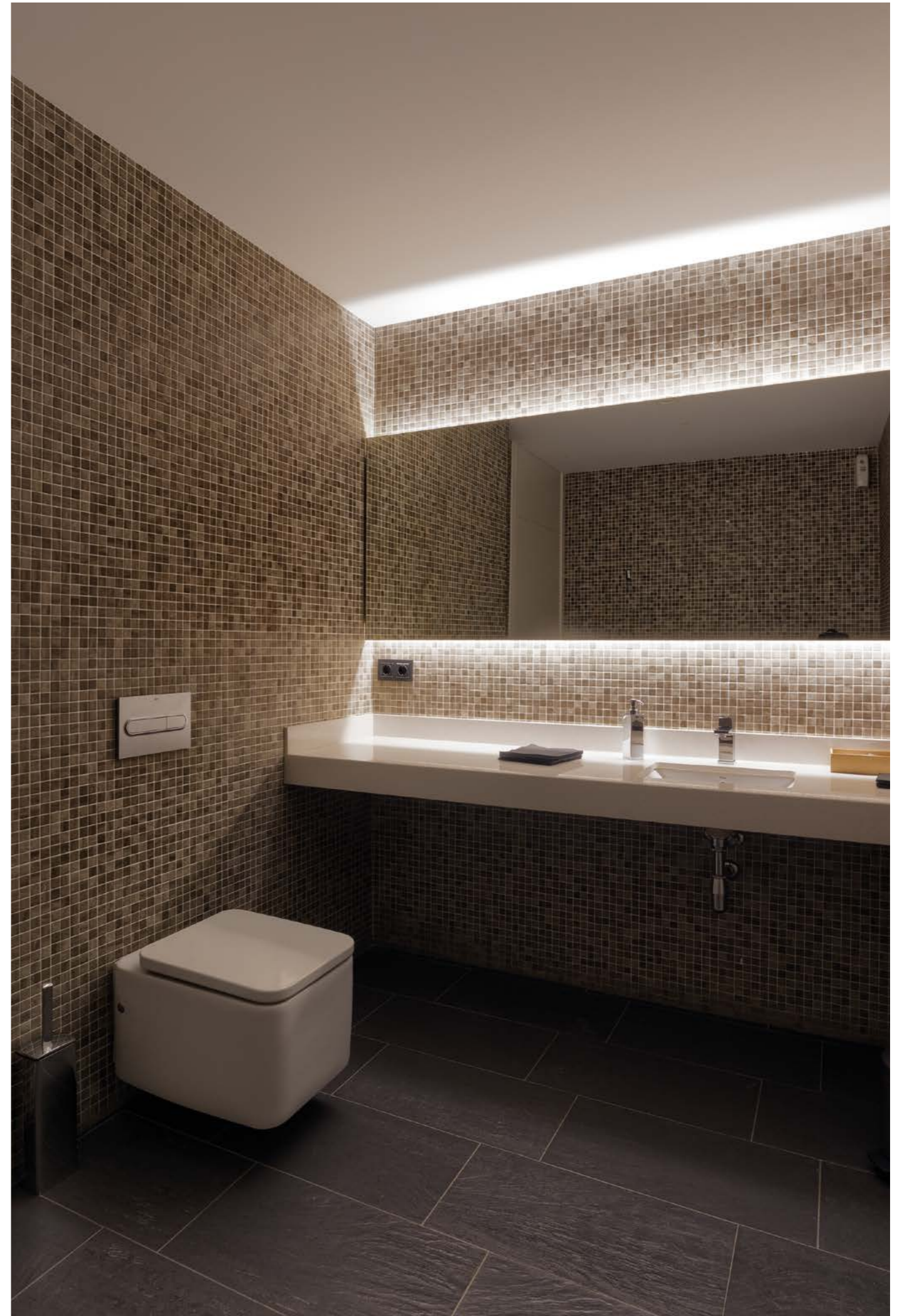

Phyllite 25
Zen Collection

Sarsen 25
Zen Collection

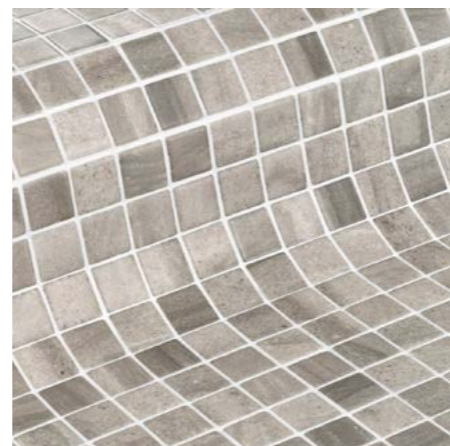

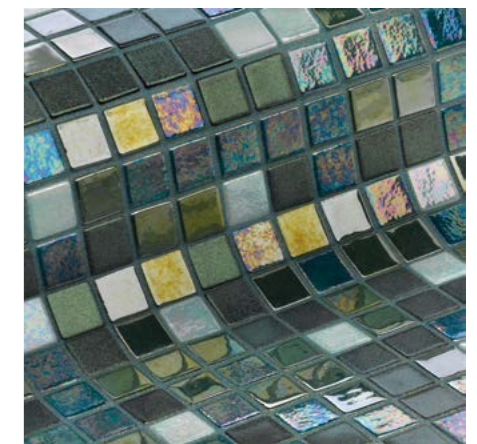

Tomahawk 25
Cocktail Collection

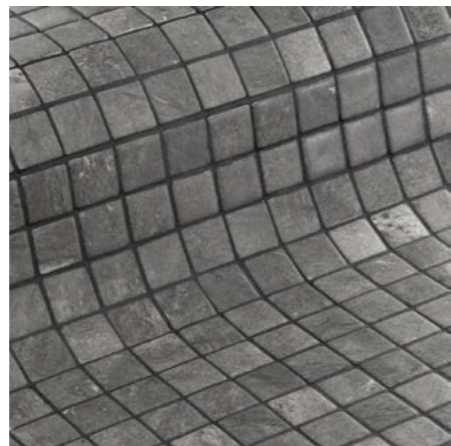
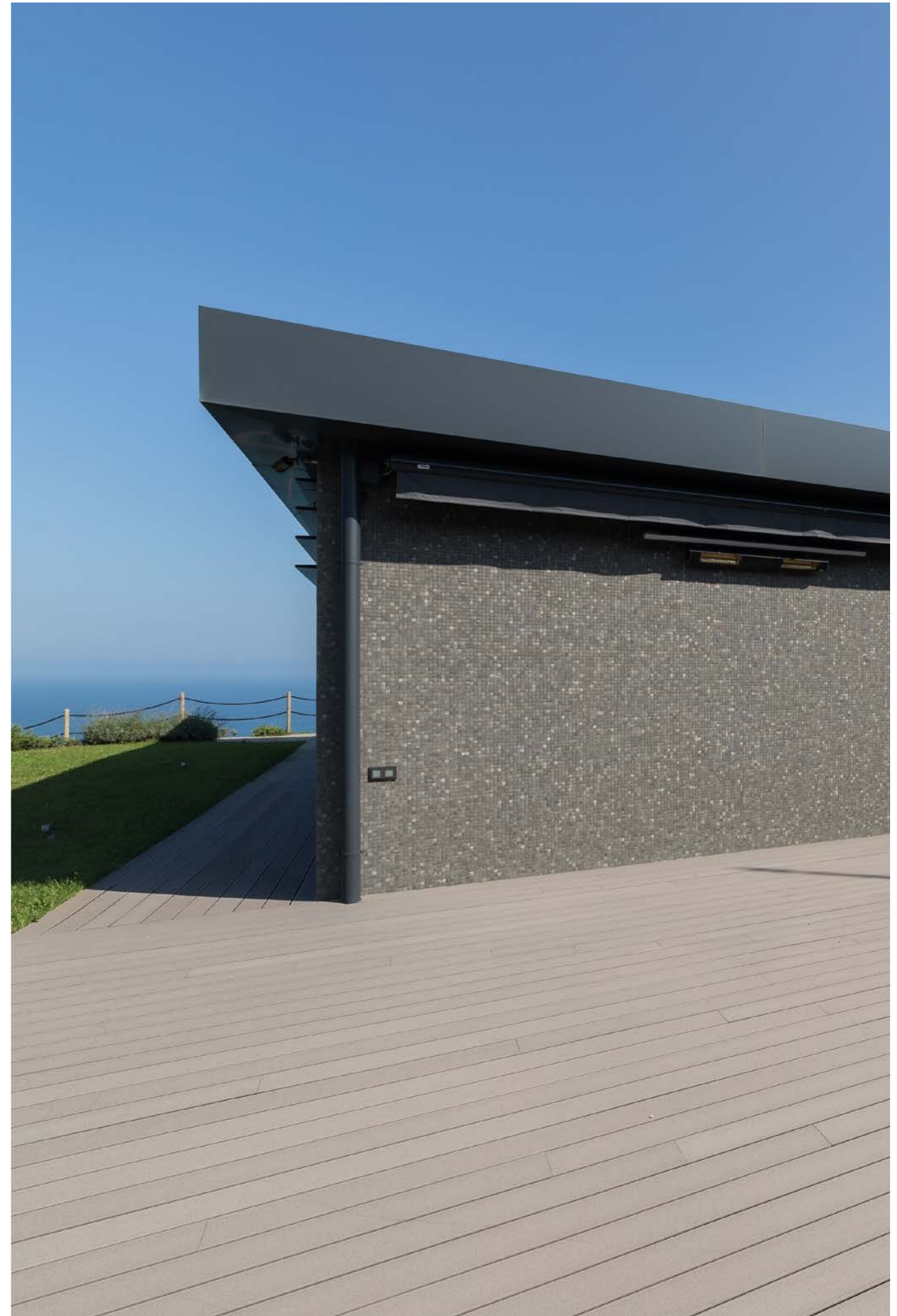

Phyllite 25
Zen Collection

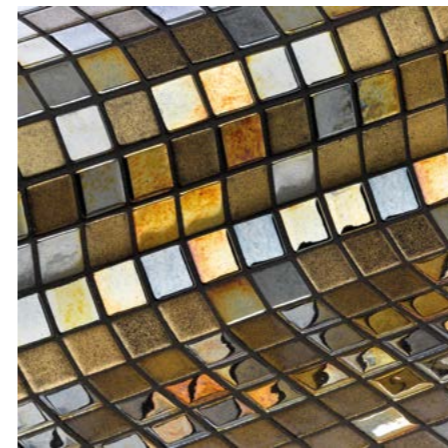

Alexander 25
Cocktail Collection

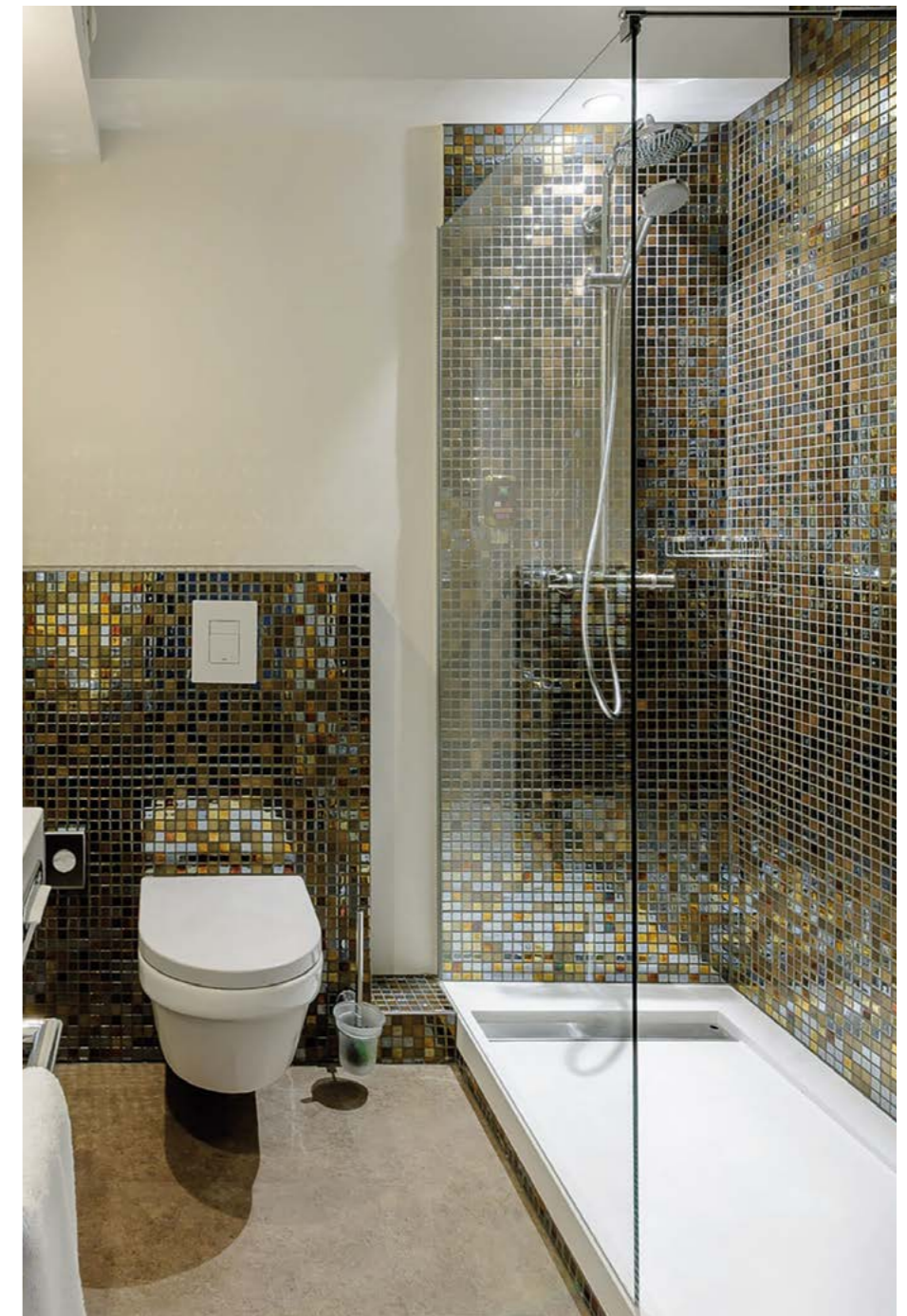



Lava 25
Metal Collection

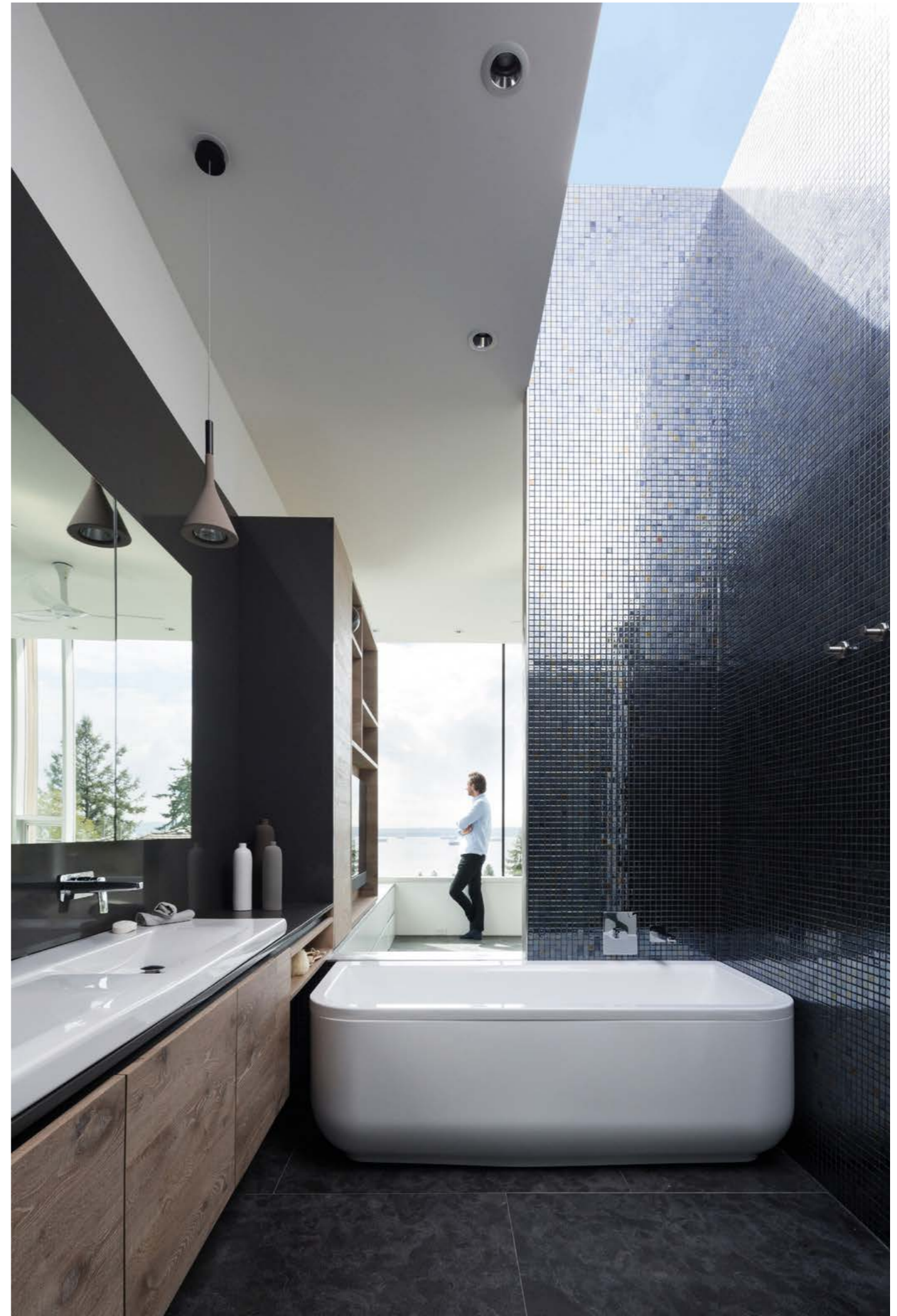



Sarsen 25
Zen Collection

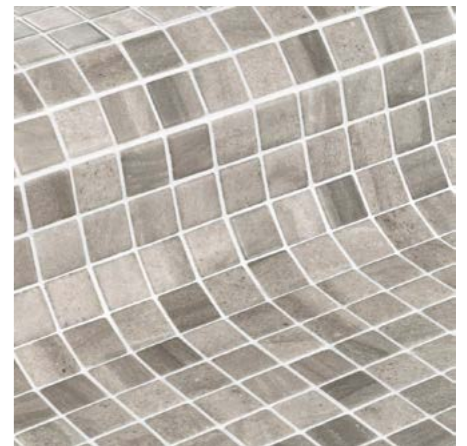



Custom Printed Mosaic
Custom Collection

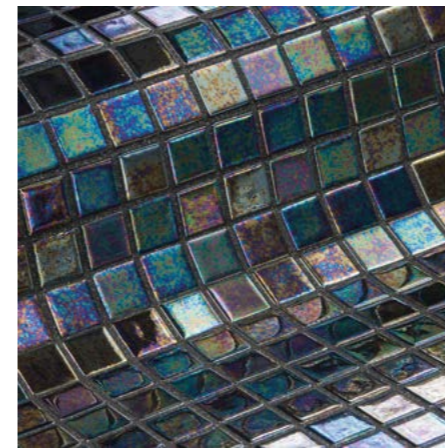

Ebano 25
Iridescent Collection

Premium Collections

Exclusive and elegant.

Collections for one-of-a-kind pool design ideas. For those who want to escape the daily routine and turn their space and the time they spend in it into something spectacular. Collections full of personality, distinction and character.



Exclusiva y elegante.

Unas colecciones para aquellos que buscan un resultado especial, diferente y único. Para quienes persiguen salir de su rutina diaria y convierten tanto su espacio, como el tiempo que pasan en él, en una experiencia singular. Colecciones con personalidad a raudales, llenas de distinción y carácter.

Exclusive et élégante.

Des collections pour ceux qui recherchent un résultat spécial, différent et unique. Pour ceux qui cherchent à sortir de leur routine quotidienne et à transformer à la fois leur espace et le temps qu'ils y passent en une expérience unique. Des collections avec une personnalité en abondance, pleines de distinction et de caractère.

Aquarelle Collection

 Antislip mosaic
 Corner & Cove available

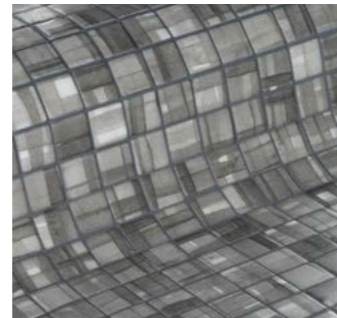
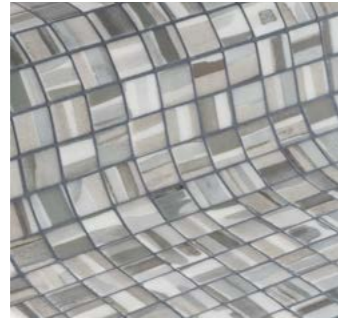

Shades 25
Joint: 100

Layers 25
Joint: 130

Stripes 25
Joint: 130

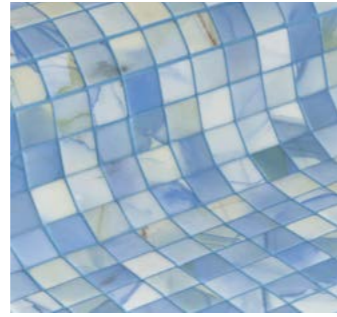
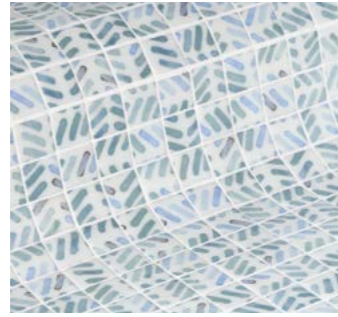
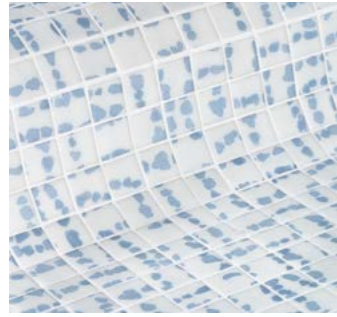

Rims 25
Joint: 100

Strokes 25
Joint: 100

Washes 25
Joint: 340

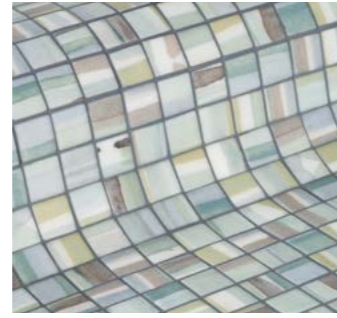
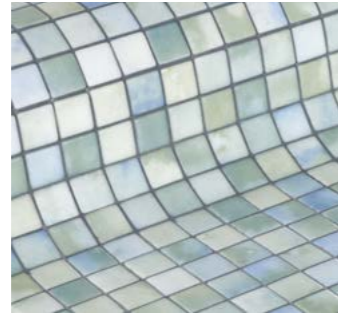

Blots 25
Joint: 100

Fluid 25
Joint: 130

Pigment 25
Joint: 130



Sponge 25
Joint: 100

Wet-in-wet 25
Joint: 100

Effect 25
Joint: 130

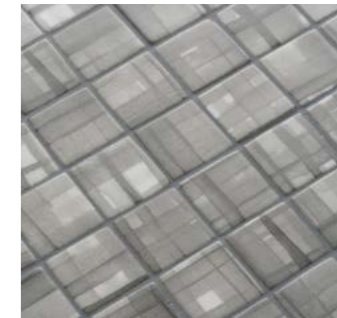

Shades 50
Joint: 100

Layers 50
Joint: 130

Stripes 50
Joint: 130

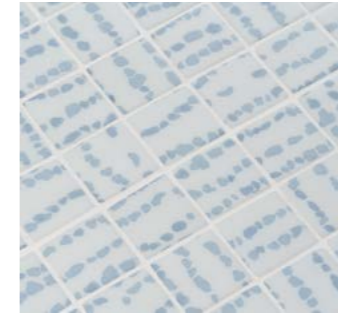

Rims 50
Joint: 100

Strokes 50
Joint: 100

Washes 50
Joint: 340

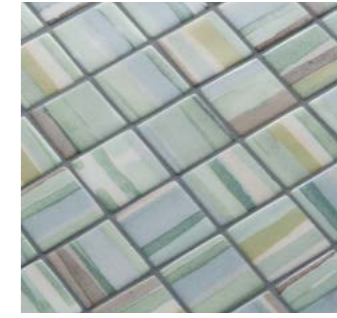
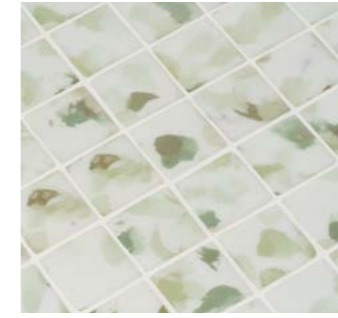

Blots 50
Joint: 100

Fluid 50
Joint: 130

Pigment 50
Joint: 130





Sponge 50
Joint: 100

Wet-in-wet 50
Joint: 100

Effect 50
Joint: 130

Zen Collection

-  Antislip version available
-  Antislip mosaic
-  Corner & Cove available

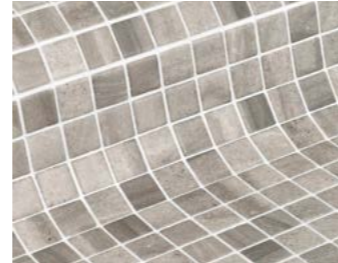
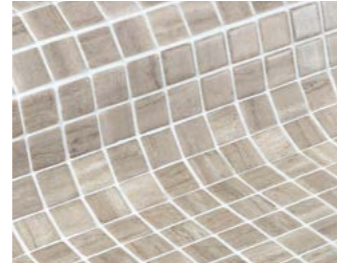

Carrara 25
Joint: 100

Ash 25
Joint: 100

Creamstone 25
Joint: 100

Sarsen 25
Joint: 100

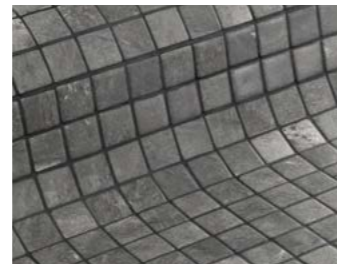
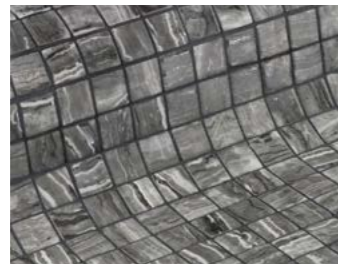

Fior di Bosco 25
Joint: 145

Tigrato 25
Joint: 145

Phyllite 25
Joint: 145

Black Marble 25
Joint: 145

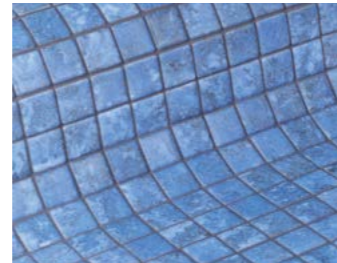
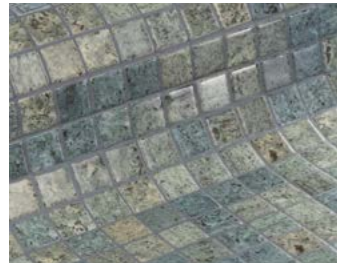

Bali Stone 25
Joint: 130

Makauba 25
Joint: 340

Bluestone 25
Joint: 130

Dolerite 25
Joint: 130



Pale Cherry 25
Joint: 100

Oak 25
Joint: 100

Sandstone 25
Joint: 100

Travertino 25
Joint: 100

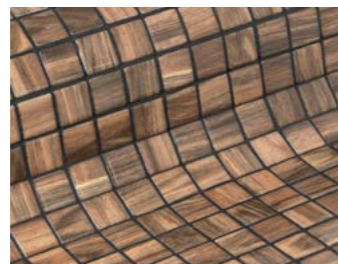

Riverstone 25
Joint: 145

Palisandro 25
Joint: 145

Rustic 25
Joint: 145



Carrara 50
Joint: 100

Ash 50
Joint: 100

Creamstone 50
Joint: 130

Sarsen 50
Joint: 130

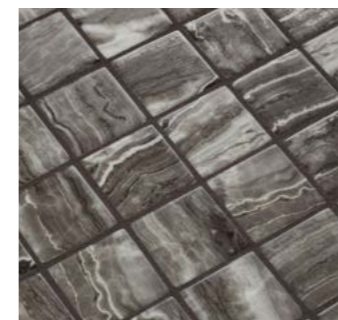

Flor di Bosco 50
Joint: 145

Tigrato 50
Joint: 145

Phyllite 50
Joint: 145

Bali Stone 50
Joint: 145

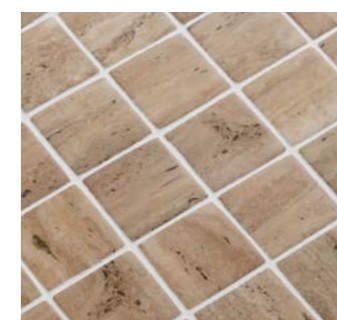
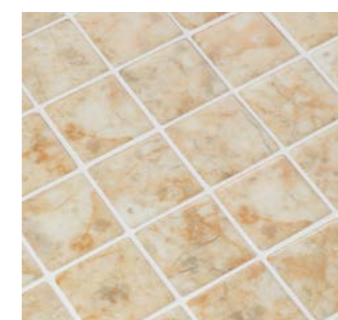
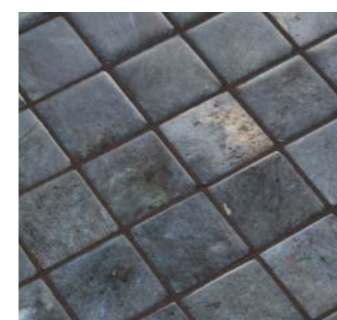

Dolerite 50
Joint: 145

Bluestone 50
Joint: 130

Sandstone 50
Joint: 100

Travertino 50
Joint: 100

Gold Collection

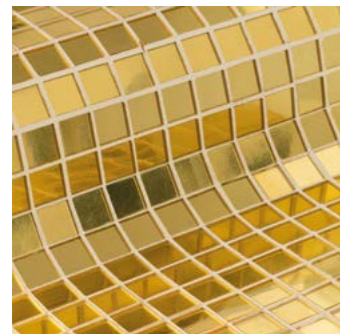

Gold 25
Joint: 208 + Gold

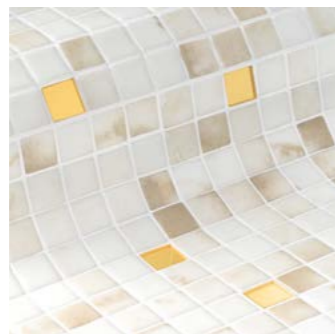

Sponge Gold 25
Joint: 100
Sponge 25 (98%)
Gold 25 (2%)

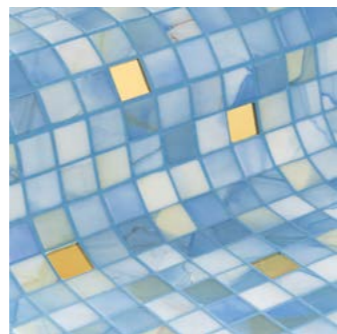

Washes Gold 25
Joint: 340
Washes 25 (98%)
Gold 25 (2%)



Carrara Gold 25
Joint: 100
Carrara 25 (98%)
Gold 25 (2%)

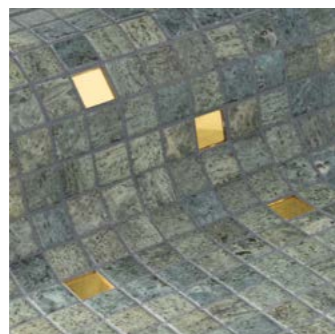

Bali Stone Gold 25
Joint: 130
Bali Stone 25 (98%)
Gold 25 (2%)

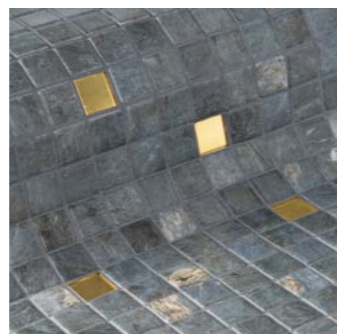

Dolerite Gold 25
Joint: 130
Dolerite 25 (98%)
Gold 25 (2%)

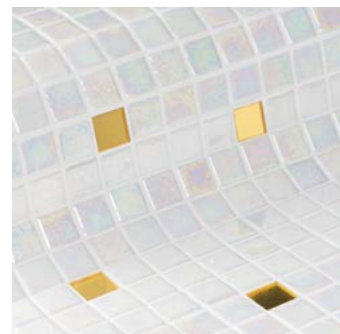

Perla Gold 25
Joint: 100
Perla 25 (98%)
Gold 25 (2%)

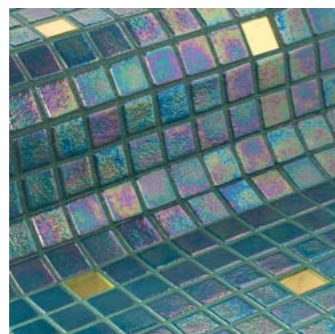

Jade Gold 25
Joint: 430+Gold
Jade 25 (98%)
Gold 25 (2%)

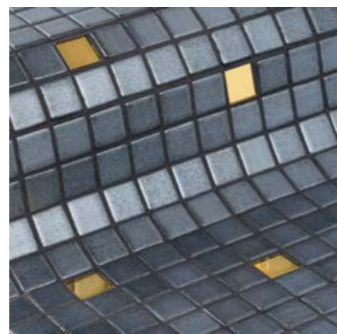

Capricorn Gold 25
Joint: 145
Capricorn 25 (98%)
Gold 25 (2%)

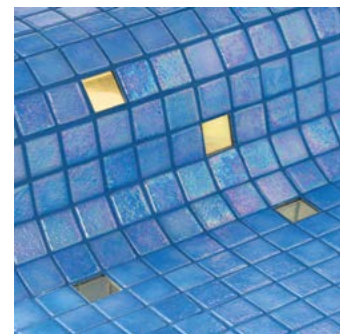

Ocean Gold 25
Joint: 350
Ocean 25 (98%)
Gold 25 (2%)

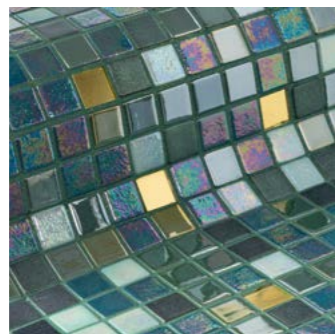

Tomahawk Gold 25
Joint: 430+Gold
Gold 25 (2%)
Coral 25 (10%)
Jade 25 (29%)
Esmeralda 25 (29%)
Taurus 25 (30%)



Alexander Gold 25
Joint: 145
Gold 25 (2%)
Oxido 25 (32%)
Lava 25 (33%)
Scorpio 25 (33%)

Cocktail Collection



Mojito 25
Joint: 100
Teide 25 (85%)
Capricorn 25 (10%)
Lava 25 (5%)

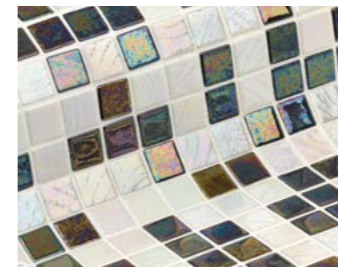

Manhattan 25
Joint: 100
Teide 25 (50%)
Ebano 25 (50%)



Daikiri 25
Joint: 100 Spotlight
Kilauea 25 (50%)
Perla 25 (40%)
Oxido 25 (10%)

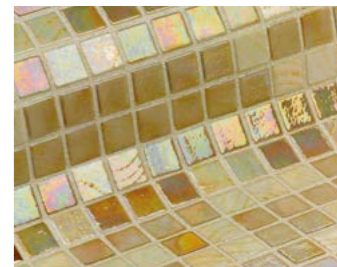

Bellini 25
Joint: 100 Gold
Arena 25 (60%)
Sajama 25 (36%)
Aurum 25 (4%)



Alexander 25
Joint: 145
Scorpio 25 (34%)
Lava 25 (33%)
Oxido 25 (33%)

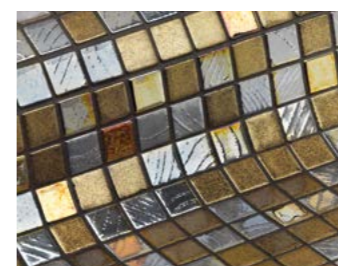

Kir Royal 25
Joint: 145
Etna 25 (45%)
Scorpio 25 (45%)
Oxido 25 (10%)

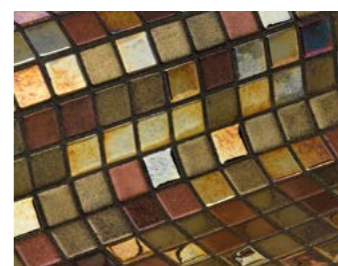

Cosmopolitan 25
Joint: 145 Gold
Scorpio 25 (34%)
Leo 25 (33%)
Oxido 25 (33%)

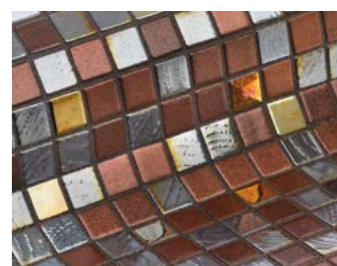

Bloody Mary 25
Joint: 145 Spotlight
Oxido 25 (10%)
Etna 25 (45%)
Leo 25 (45%)



Margarita 25
Joint: 145
Lava 25 (90%)
Aurum 25 (10%)

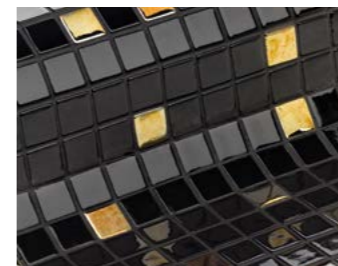

Eclipse 25
Joint: 145
2530-D 25 (90%)
Oxido 25 (10%)



Gin Fizz 25
Joint: 145 Spotlight
Inox 25 (10%)
2560-A 25 (10%)
Capricorn 25 (70%)
Lava 25 (10%)

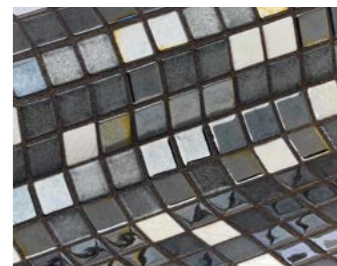

San Francisco 25
Joint: 145
Teide 25 (10%)
Capricorn 25 (45%)
Lava 25 (45%)



Caipirinha 25
Joint: 320
Coral 25 (70%)
Teide 25 (20%)
Capricorn 25 (10%)



Long Island 25
Joint: 350 Spotlight
Ocean 25 (60%)
Stromboli 25 (30%)
Sagittarius 25 (10%)

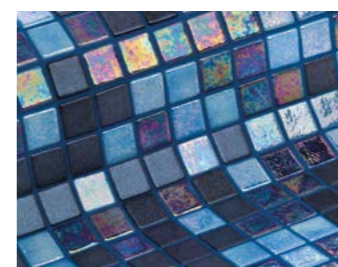

Blue Lagoon 25
Joint: 350
Azur 25 (33%)
Zafiro 25 (33%)
Sagittarius 25 (34%)

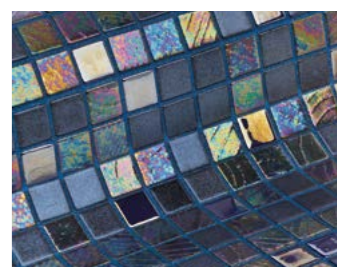

Blue Moon 25
Joint: 350 Spotlight
Vesubio 25 (45%)
Sagittarius 25 (45%)
Azurita 25 (10%)

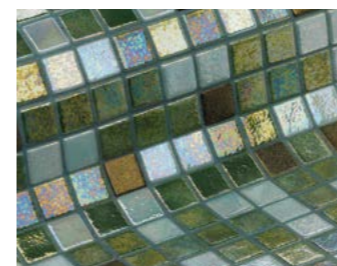

Grasshopper 25
Joint: 340 Gold
Green Pearl 25 (62%)
Coral 25 (30%)
Aquarius 25 (8%)

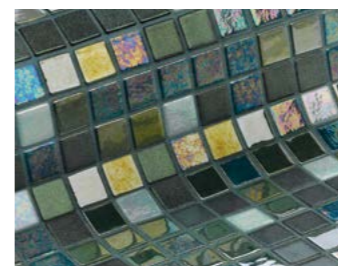

Tomahawk 25
Joint: 340 Gold
Jade 25 (30%)
Coral 25 (10%)
Esmeralda 25 (30%)
Taurus 25 (30%)

Iridescent Collection

 Antislip version available

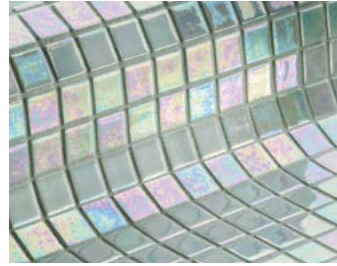

Perla 25
Joint: 100 Spotlight



Diamond 25
Joint: 100 Spotlight

Perla 25 (30%)
2545-A 25 (70%)

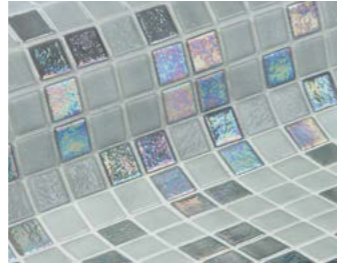

Stone 25
Joint: 100 Spotlight

Cuarzo 25 (30%)
2522-B 25 (70%)

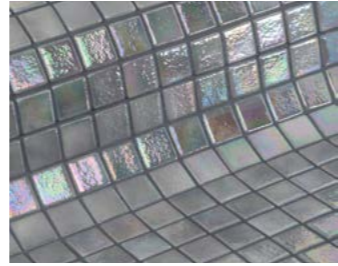

Cuarzo 25
Joint: 130

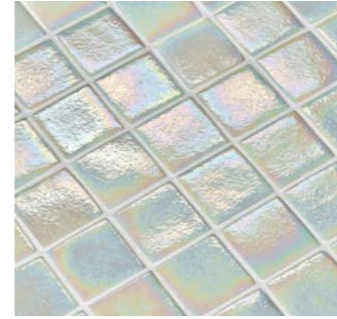

Perla 50
Joint: 100

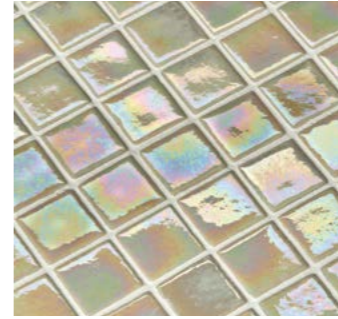

Marfil 50
Joint: 100

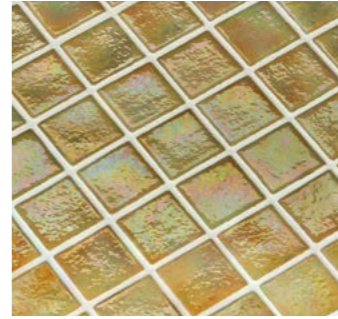

Arena 50
Joint: 100

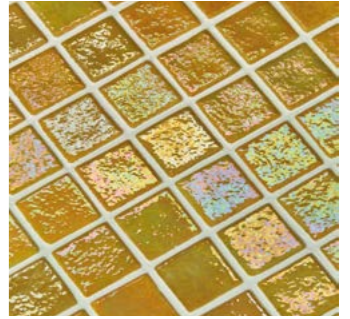

Ambar 50
Joint: 100

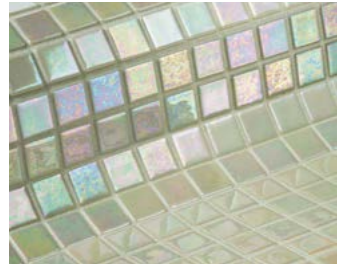

Marfil 25
Joint: 100 Gold



Sahara 25
Joint: 100 Gold

Marfil 25 (33%)
2597-B 25 (20%)
2596-B 25 (47%)

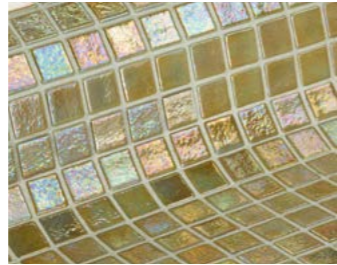

Arena 25
Joint: 100 Gold

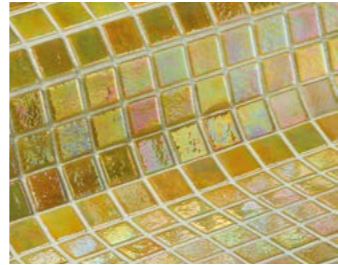

Ambar 25
Joint: 100 Gold

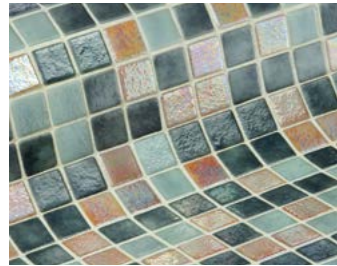

Moon 25
Joint: 100 Gold

Nacar 25 (33%)
2560-B 25 (47%)
2522-B 25 (20%)

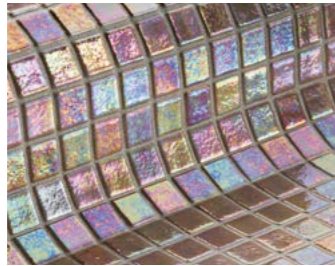

Nacar 25
Joint: 100 Spotlight

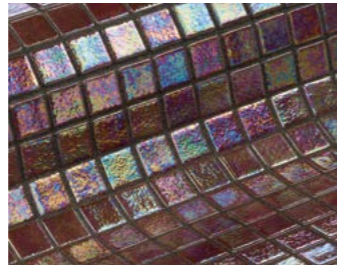

Cobre 25
Joint: 145 Gold

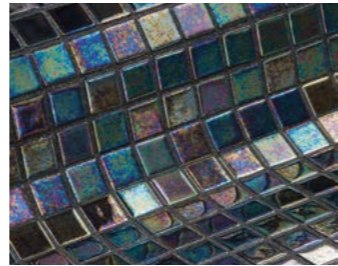

Ebano 25
Joint: 145 Spotlight

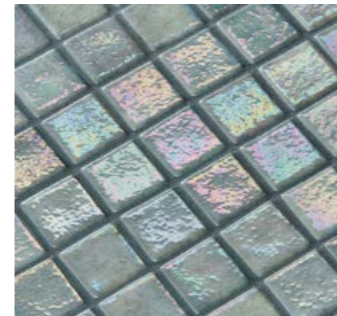

Cuarzo 50
Joint: 130

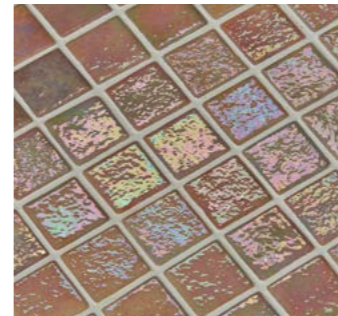

Nacar 50
Joint: 100

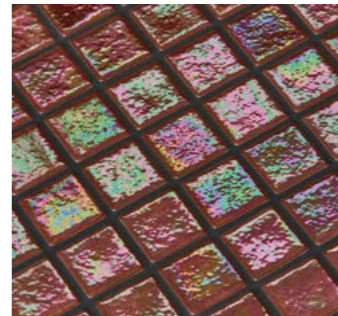

Cobre 50
Joint: 145

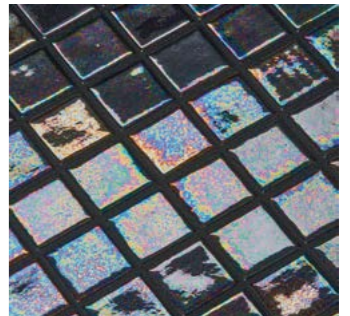

Ebano 50
Joint: 145

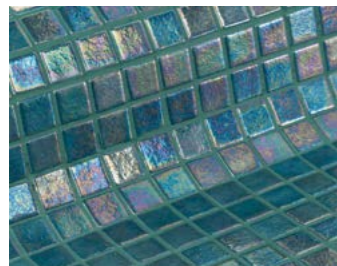

Jade 25
Joint: 430

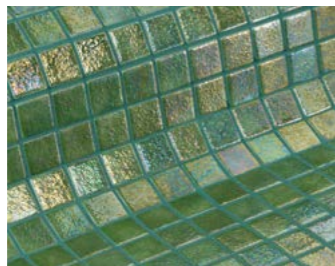

Green Pearl 25
Joint: 430

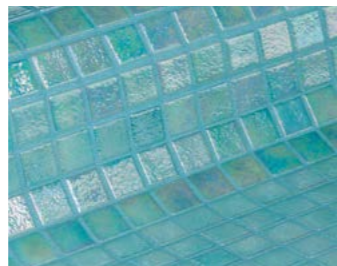

Coral 25
Joint: 320 Spotlight

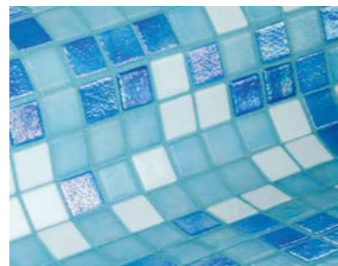

Sky 25
Joint: 320 Spotlight

Azur 25 (33%)
2545-A 25 (20%)
2521-B 25 (47%)

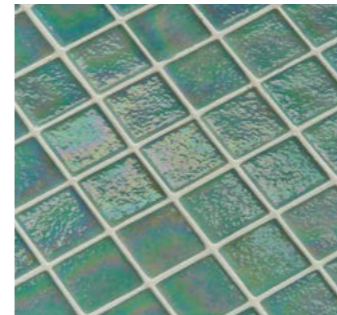

Coral 50
Joint: 100

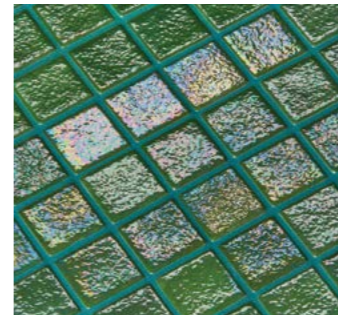

Green Pearl 50
Joint: 430

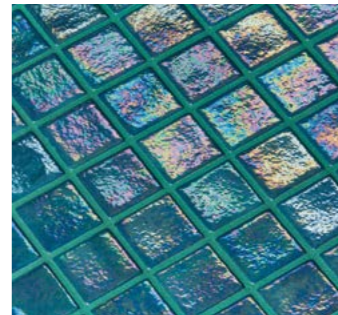

Jade 50
Joint: 430



Azur 25
Joint: 340 Spotlight

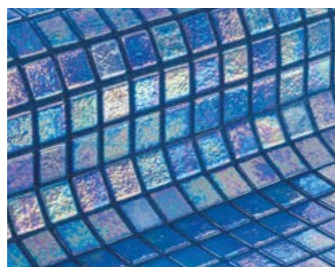

Ocean 25
Joint: 350 Spotlight



Oasis 25
Joint: 340 Spotlight

Azur 25 (33%)
2545-A 25 (20%)
2512-C 25 (47%)

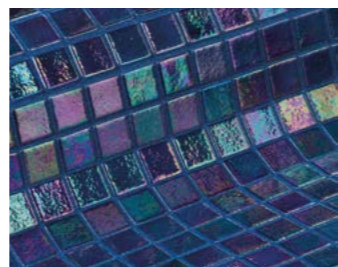

Zafiro 25
Joint: 350 Spotlight

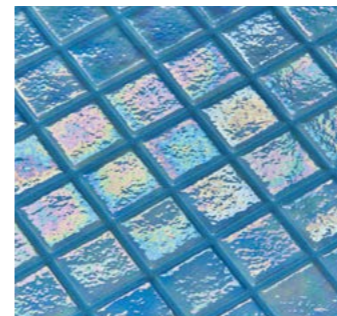

Azur 50
Joint: 340

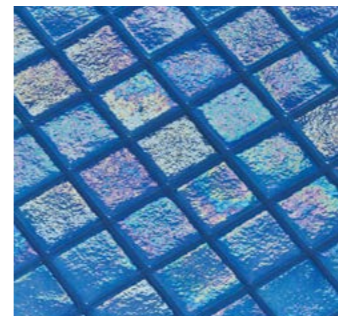

Ocean 50
Joint: 350

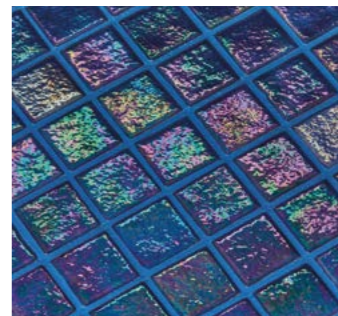

Zafiro 50
Joint: 350

Gemma Collection



Quartz 25 Joint: 100



Berilo 25 Joint: 100



Garnet 25 Joint: 130



Peridot 25 Joint: 100

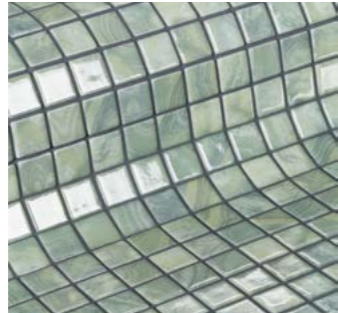

Lace 25 Joint: 130

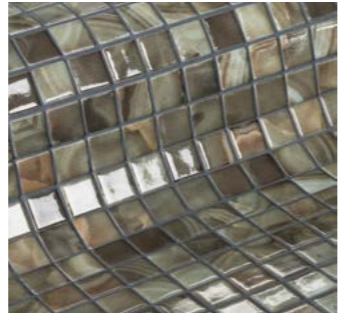

Cuprite 25 Joint: 130



Celestite 25 Joint: 100

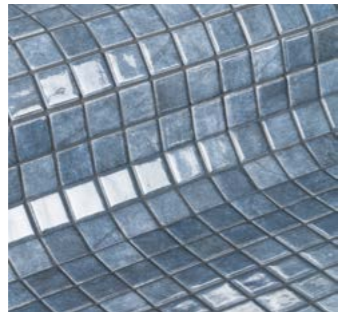

Lapis 25 Joint: 130

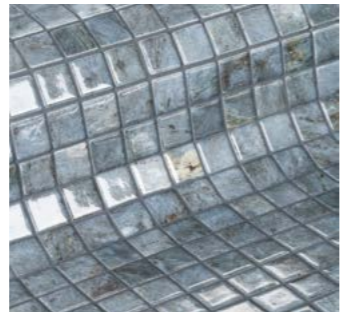

Hematite 25 Joint: 130



Gibeon 25 Joint: 100

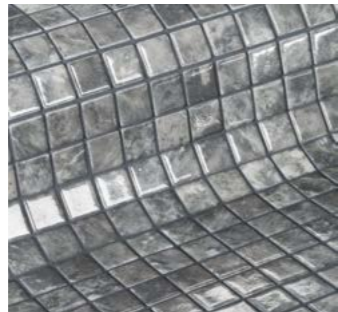

Magnet 25 Joint: 130

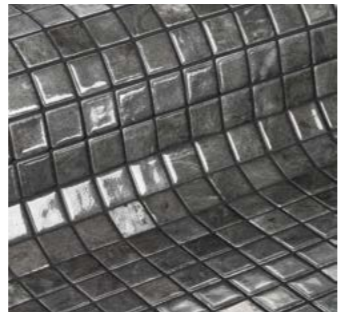

Zircon 25 Joint: 145

Metal Collection



Nickel 25 Joint: 100 Spotlight

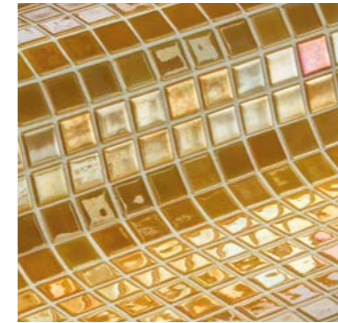

Aurum 25 Joint: 100 Gold

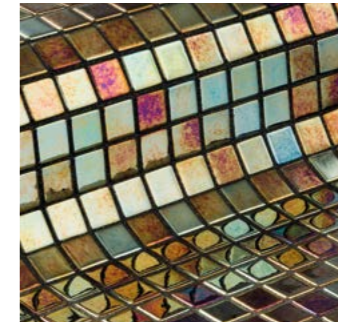

Oxido 25 Joint: 145 Gold



Inox 25 Joint: 100 Spotlight



Rubi 25 Joint: 145 Gold

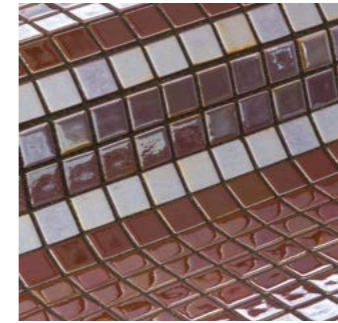

Opalo 25 Joint: 145 Gold

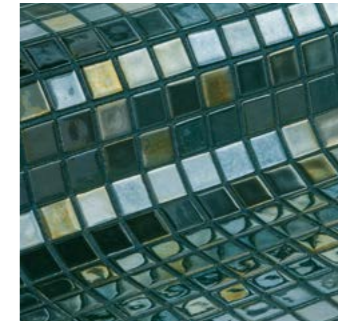

Esmeralda 25 Joint: 340 Gold



Lava 25 Joint: 145 Spotlight



Azurita 25 Joint: 350 Spotlight



Vanadium 25 Joint: 340 Spotlight

Space Collection

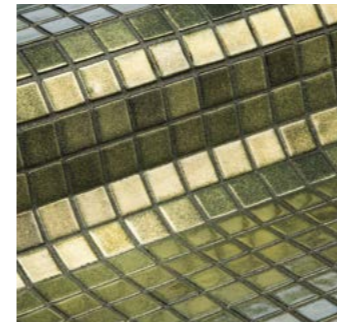

Aquarius 25 Joint: 145 Gold

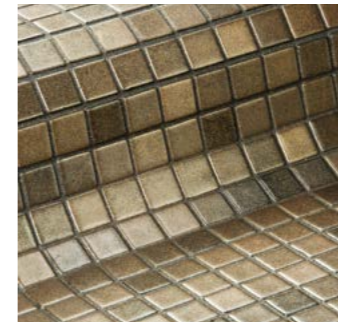

Scorpio 25 Joint: 145 Gold

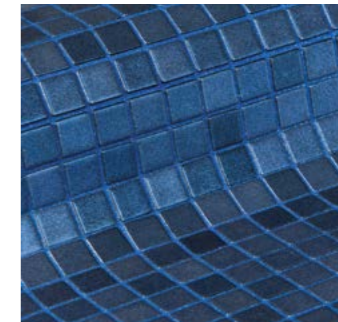

Sagittarius 25 Joint: 350 Spotlight

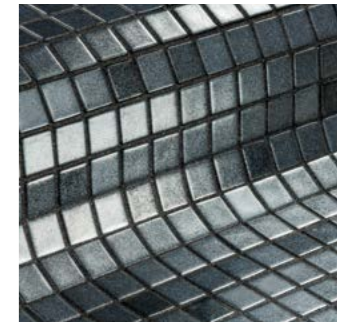

Capricorn 25 Joint: 145 Spotlight

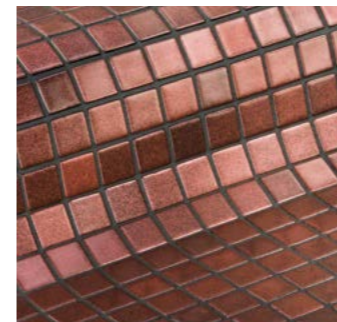

Leo 25 Joint: 145

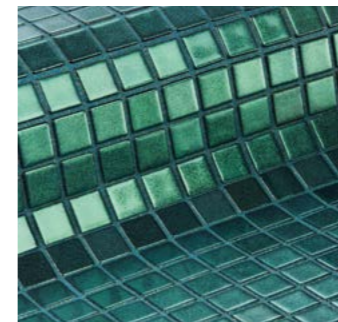

Taurus 25 Joint: 340 Gold

Fosfo Collection

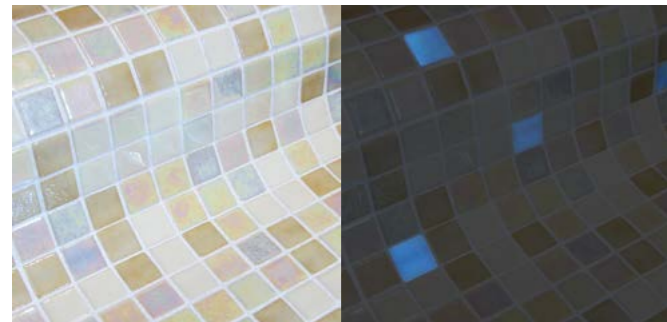

Argo 25 Joint: 100 Gold
Fosfo Beige Iridescent 25 (4%) 2597-B 25 (26%)
2551-A 25 (26%) Marfil 25 (44%)

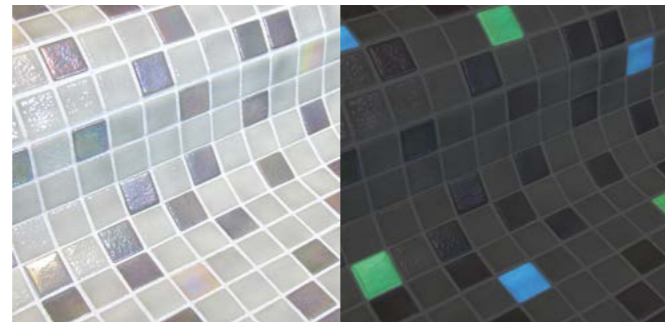

Serpens 25 Joint: 100 Spotlight
Fosfo Beige Iridescent 25 (2%) Cuarzo 25 (24%)
Fosfo Grey Iridescent 25 (2%) 2522-B 25 (72%)

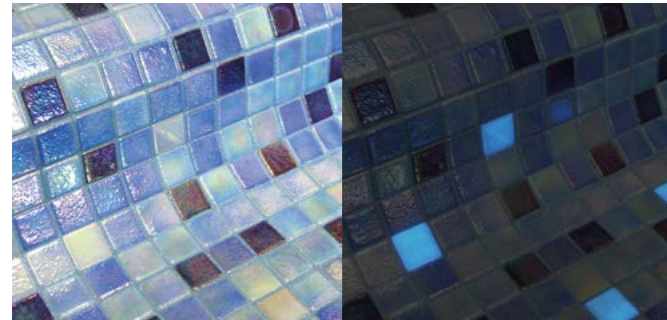

Delphinus 25 Joint: 340 Spotlight
Fosfo Blue Iridescent 25 (4%) Ocean 25 (40%)
Azur 25 (42%) Zafiro 25 (14%)

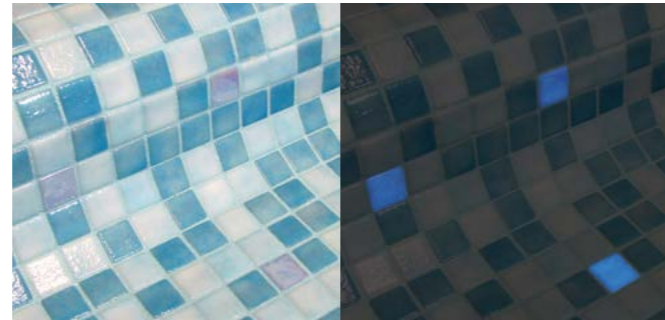

Aquila 25 Joint: 320 Spotlight
Fosfo Blue Iridescent 25 (4%) 2508-A 25 (48%)
2521-B 25 (48%)



Draco 25 Joint: 100 Gold
Fosfo Beige Iridescent 25 (4%) Lava 25 (10%)
Perla 25 (14%) 2545-A 25 (72%)

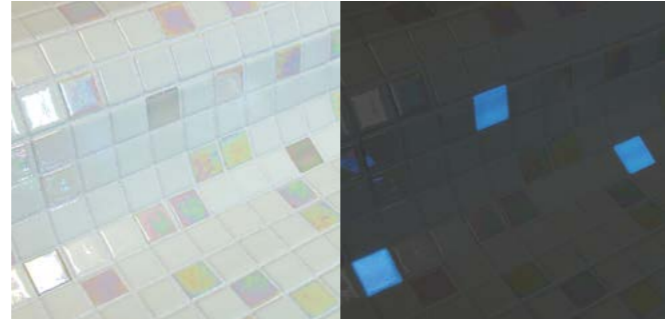

Lepus 25 Joint: 100 Spotlight
Fosfo Beige Iridescent 25 (4%) 2545-A 25 (72%)
Perla 25 (24%)

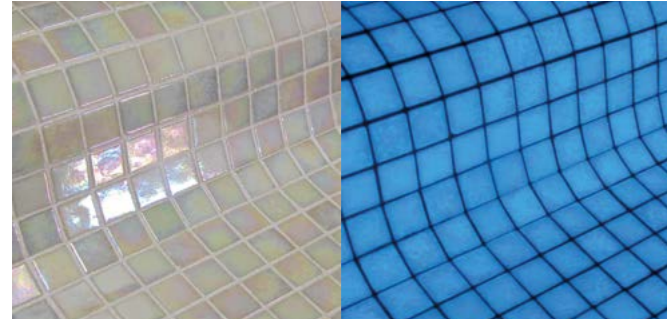

Fosfo Beige Iridescent 25 Joint: 100 Gold

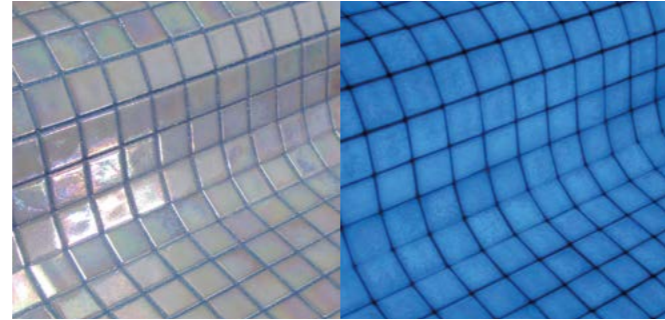

Fosfo Blue Iridescent 25 Joint: 340 Spotlight

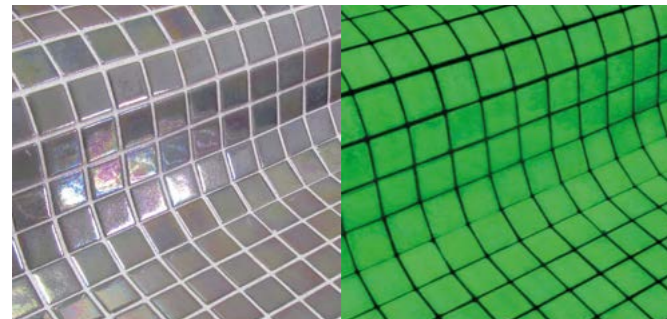

Fosfo Grey Iridescent 25 Joint: 100 Spotlight

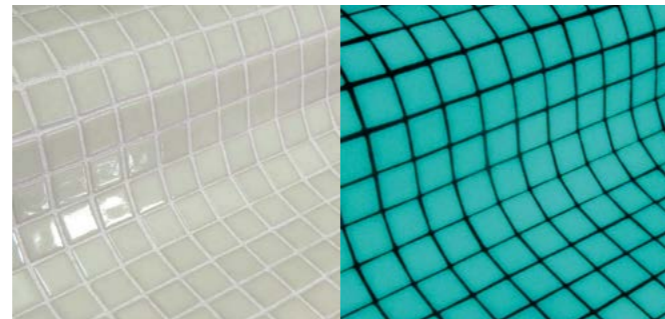

Fosfo 25 Joint: 100 Gold



Vulcano Collection

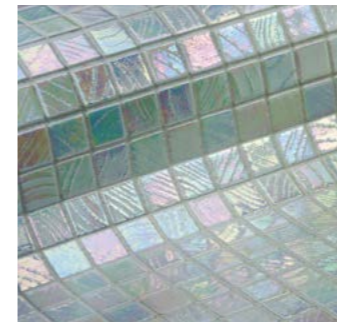

Teide 25 Joint: 100 Spotlight

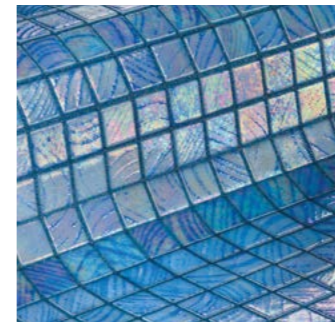

Stromboli 25 Joint: 340 Spotlight

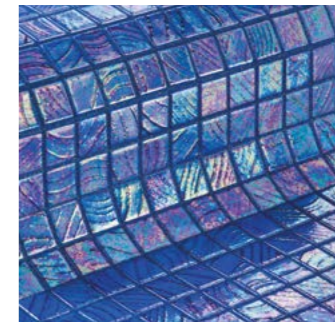

Santorini 25 Joint: 350 Spotlight

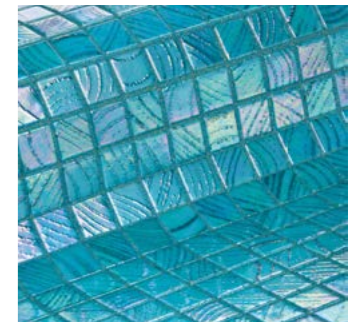

Fuji 25 Joint: 340 Gold

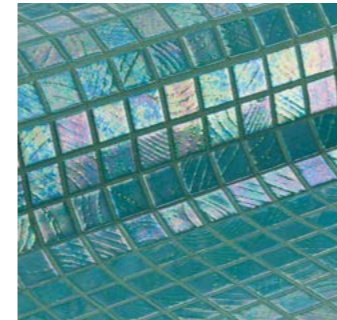

Irazu 25 Joint: 320 Gold

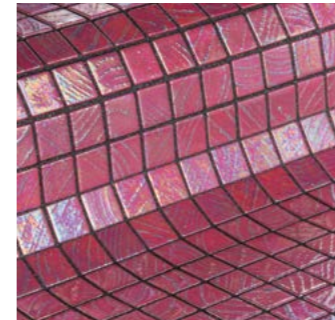

Mauna Loa 25 Joint: 145 Spotlight

Topping Collection

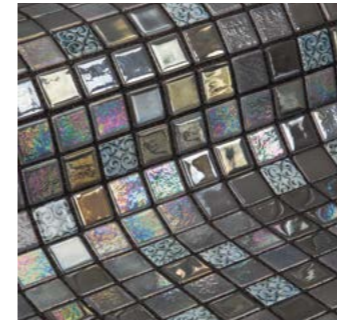

Mochi 25 Joint: 145 Spotlight
Inox 25 (40%) Cuarzo 25 (40%)
2560-A 25 (10%) Mochi Mosaic 25 (10%)

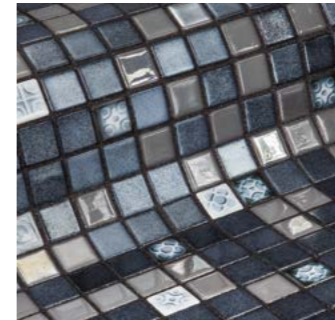

Silver Bits 25 Joint: 145 Spotlight
Capricorn 25 (55%) Inox 25 (10%)
2544-A 25 (25%) Silver Bits Mosaic 25 (10%)

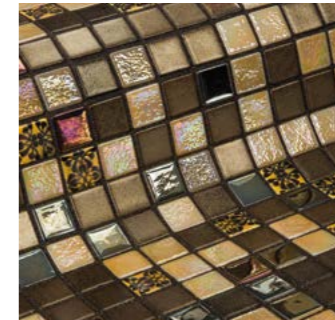

Almonds 25 Joint: 145 Gold
Oxido 25 (20%) Arena 25 (25%)
Scorpio 25 (47%) Almonds Mosaic 25 (8%)

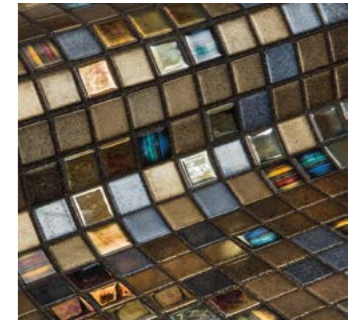

Pecans 25 Joint: 145 Gold
Oxido 25 (20%) Capricorn 25 (25%)
Scorpio 25 (45%) Pecans Mosaic 25 (10%)



Drops 25 Joint: 340 Spotlight
2510-A 25 (25%) Azur 25 (40%)
2508-A 25 (25%) Drops Mosaic 25 (10%)

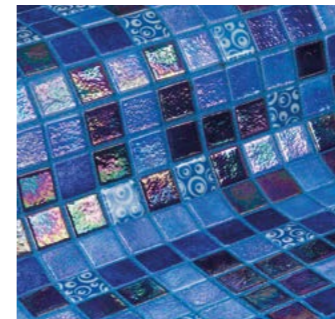

Blueberries 25 Joint: 340 Spotlight
Zafiro 25 (25%) 2562-B 25 (25%)
Ocean 25 (40%) Blueberries Mosaic 25 (10%)

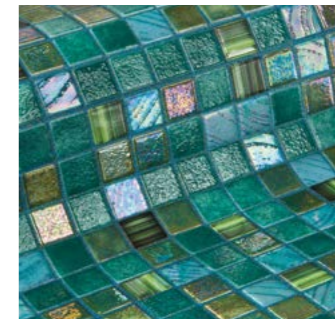

Kiwi 25 Joint: 340 Gold
Green Pearl 25 (45%) Fuji 25 (10%)
2586-B 25 (35%) Kiwi Mosaic 25 (10%)



Violet 25 Joint: 100 Gold
2564-B 25 (25%) 2524-B 25 (30%)
Nacar 25 (35%) Violet Mosaic 25 (10%)

Safe Steps ANTI-SLIP System

Ezarrí's Safe-Steps no-slip system can be applied to a wide variety of SKUs from different collections, all in stock.

El sistema antideslizante Safe-Steps de ezarri se aplica a una amplia variedad de referencias de distintas colecciones, todas ellas en stock.

Le système antidérapant Safe Steps d'ezarri s'applique à une grande variété de références de différentes collections, toutes en stock.

Maximun Safety

Mets the technical Building Code and the highest international standards. Perfect for wet, slippery, or sloped outdoors. excellent for damp areas inside or out.

Máxima seguridad

Cumpliendo tanto con el Código técnico de la edificación como con los estándares más estrictos a nivel internacional. Indicado para exteriores mojados, resbaladizos y superficies en pendiente. excelente para zonas húmedas tanto interiores como exteriores.

Sécurité maximale

Respecte le Code technique de la construction tout comme les normes les plus strictes au niveau international. Indiqué pour les extérieurs mouillés et glissants ainsi que les surfaces en pente. Excellent pour les zones humides intérieures comme extérieures.

Non-bumpy texture

Smooth finish so you can walk safely. Enjoy the texture of safe-steps:

- Smooth
- Not bumpy
- Not rough
- Not coarse

Textura no rugosa

Acabados suaves que aportan seguridad al caminar.sorpréndete con la textura de safe-steps:

- Suave
- No rugoso
- No áspero
- No agresivo

Texture non ruguese

Finitions douces qui offrent plus de sécurité pour la marche. Laissez-vous surprendre par la texture de safe-steps :

- Doux
- Non rugueux
- Non raboteux
- Non agressif

Easy to clean

Its smooth texture make it easy to clean the mosaic during installation and throughout its use.All usual cleaning products can be used. Passes the chemical resistance test (UNE EN ISO 10545-13) Usual pool cleaning products can be used.

Facilidad de limpieza

Su textura suave facilita la limpieza tanto en la instalación del mosaico como en su mantenimiento. Sin problema en la utilización de productos de limpieza habituales.supera el test de Resistencia química (UEE EN ISO 10545-13). Apto para utilización de productos habituales de limpieza en piscina.

La facilité de nettoyage

Sa texture douce simplifie le nettoyage, que ce soit lors de l'installation de la mosaïque ou de son entretien. Aucun problème lors de l'utilisation de produits de nettoyage habituels.Passe le test de résistance chimique (UNE EN ISO 10545-13). Apte pour l'utilisation de produits habituels de nettoyage dans les piscines.

Our icons to identify:



Antislip version available

Reference available in antislip and non-antislip version.

Referencia disponible en acabados normal y antideslizante.

Référence disponible en finition lise et antidérapante.



Antislip mosaic

Reference only available in antislip finish.

Referencia disponible únicamente en acabado antideslizante.

Référence uniquement disponible en finition antidérapante.

Anti-slip DIN 51097	C
Anti-slip DIN 51130	R10
Anti-slip (Pendulum)	Class 3
UNE-ENU 12633: 2003	



Special Pieces: Corner & Cove

Corner and Cove pieces give your pool a graceful premium finish. They are perfect for finishing off the edges of steps and providing a seamless transition from vertical to horizontal surfaces.

The finish is slip-resistant, using the Ezarri Safe-Steps system.

Special Corner and Cove pieces are available in a wide range of styles, all in stock.

Our icons to identify:



Corner & Cove available

Corner & Cove pieces available.

Piezas Corner & Cove disponibles.

Pièces Corner et Cove disponibles

Las piezas Corner y Cove proporcionan una terminación premium para tu proyecto. Resultan perfectas para rematar las aristas de escalones, coronaciones de piscina y transiciones entre pavimentos y paredes verticales.

El acabado es antideslizante, utilizando el sistema Safe-Steps de Ezarri.

Las piezas especiales Corner y Cove están disponibles en una gran variedad de referencias, todas ellas en stock.

Les pièces Corner et Cove offrent une finition haut de gamme pour votre projet. Elles s'avèrent parfaites pour finir les bords de marches, les couronnements de piscine et les transitions entre les trottoirs et les murs verticaux.

En utilisant le système Safe-Steps d'Ezarri, la finition est antidérapante.

Les pièces spéciales Corner et Cove sont disponibles dans une variété de références, toutes en stock.



Cove

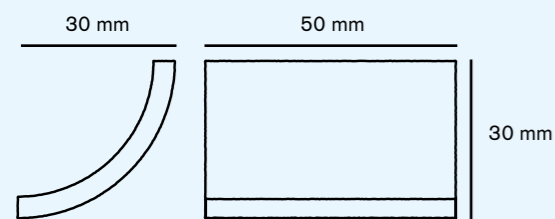

Corner

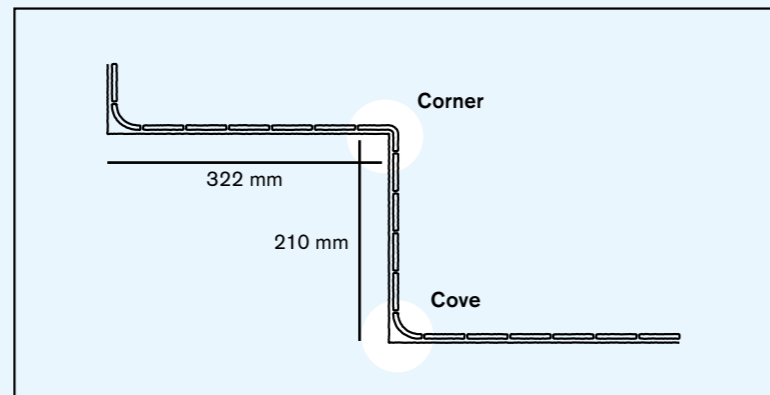
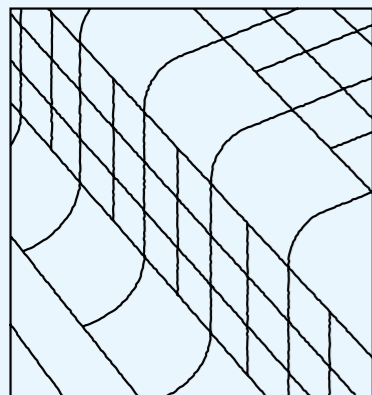
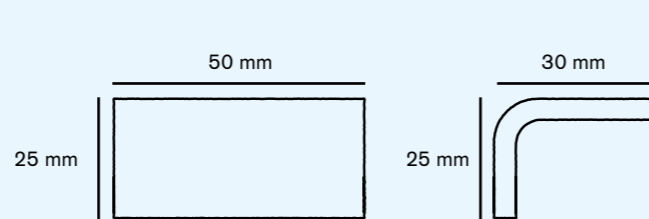

Classic Collections

Timeless and harmonious.

Collections that align perfectly with the surroundings, trends and the test of time.

With their timeless, high-quality design, any of the Classic collections are a safe bet for those who have always dreamed of owning a swimming pool - and enjoying it forever.

Atemporal y armónica.

Unas colecciones que se integran perfectamente al entorno, a las tendencias y al paso del tiempo.

Con un diseño clásico de alta calidad, cualquiera de las colecciones Classic son una apuesta segura para quienes sueñan con una piscina desde siempre... y para siempre.

Intemporel et harmonique.

Des collections qui s'intègrent parfaitement dans le cadre, les tendances et le passage du temps.

Avec un design classique de haute qualité, n'importe quelle collection Classic est une valeur sûre pour ceux qui rêvent d'une piscine depuis toujours... et pour toujours.

Lisa Collection



Niebla Collection

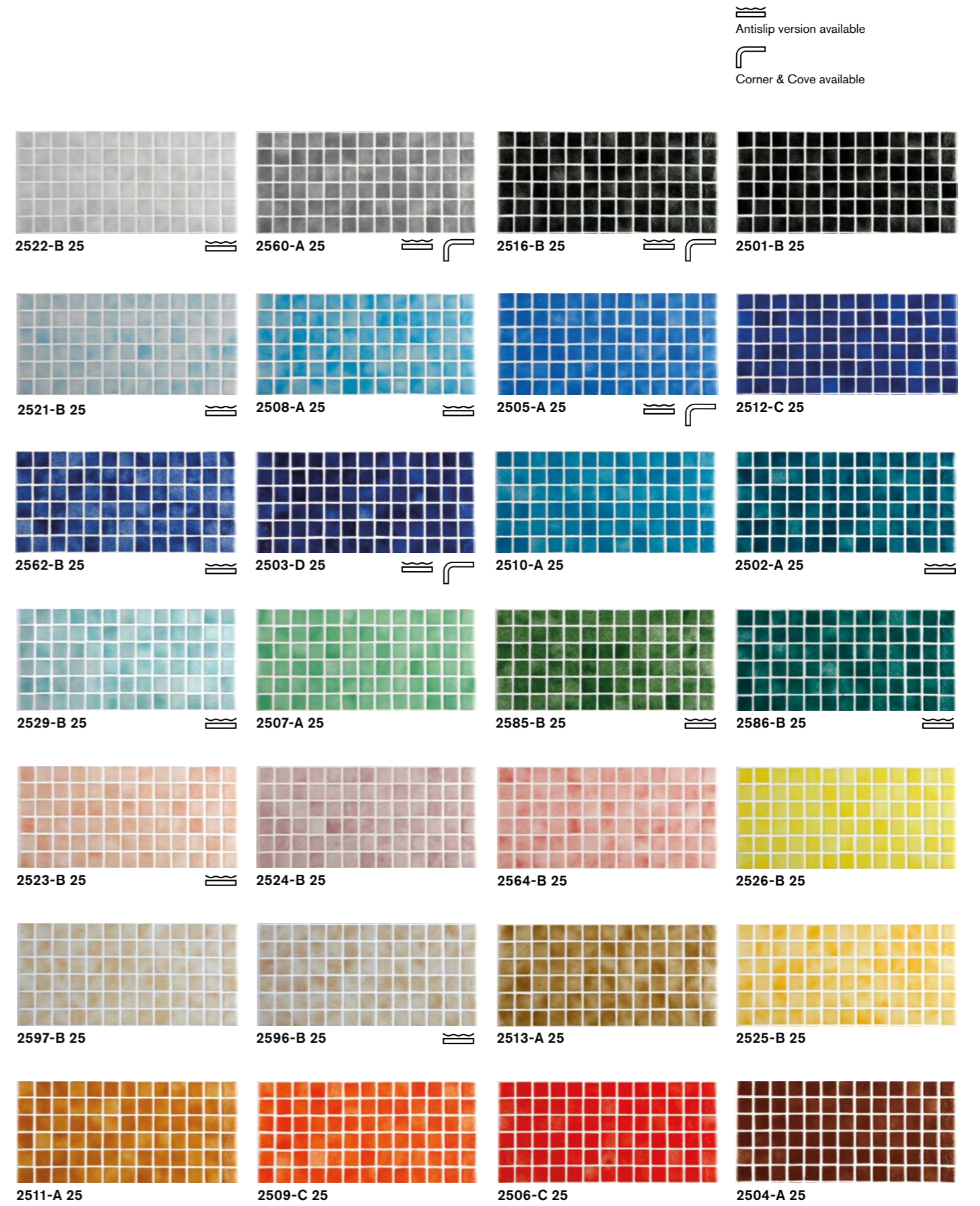







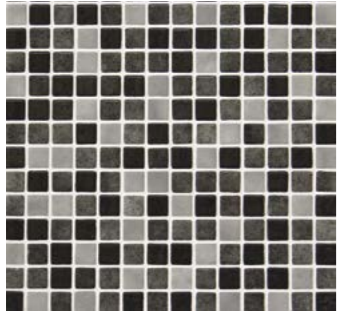

Antislip version available

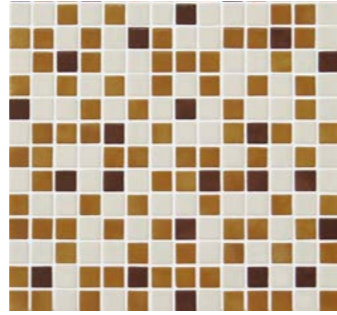
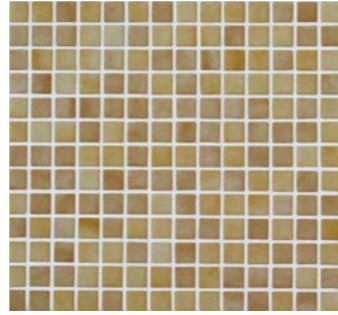
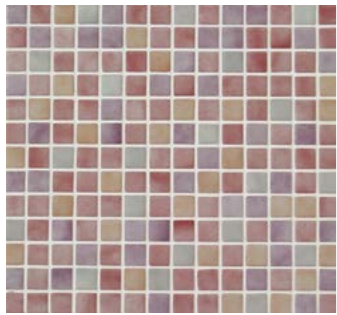
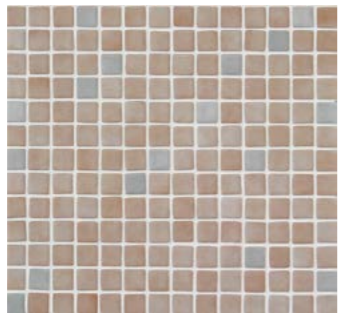
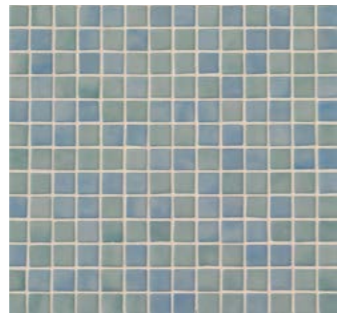
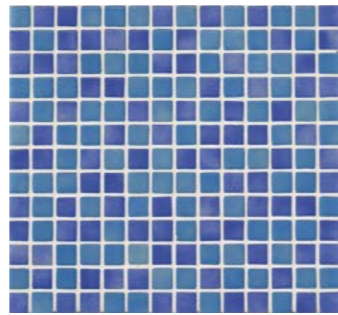
Corner & Cove available

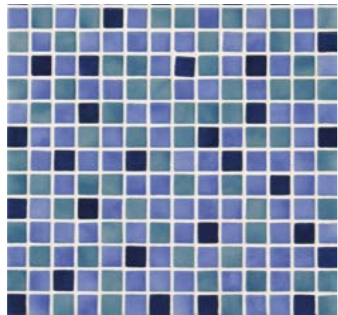

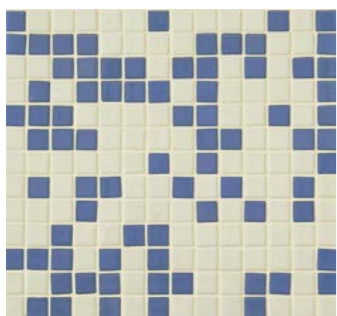

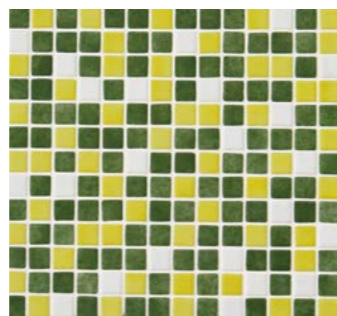
Mix Collection

Degradados

 <p>25007-C 25</p> <ul style="list-style-type: none"> 2501-B 25 (30%) 2560-A 25 (22%) 2516-B 25 (48%) 	 <p>25008-D 25</p> <ul style="list-style-type: none"> 2501-B 25 (20%) 2522-B 25 (34%) 2560-A 25 (27%) 2545-A 25 (19%) 	 <p>25012-C 25</p> <ul style="list-style-type: none"> 2504-A 25 (12%) 2551-A 25 (44%) 2560-A 25 (27%) 2511-A 25 (44%) 	 <p>2576-B 25</p> <ul style="list-style-type: none"> 2596-B 25 (50%) 2597-B 25 (50%)
 <p>25009-D 25</p> <ul style="list-style-type: none"> 2522-B 25 (10%) 2524-B 25 (24%) 2564-B 25 (51%) 2523-B 25 (15%) 	 <p>2514-B 25</p> <ul style="list-style-type: none"> 2523-B 25 (90%) 2522-B 25 (10%) 	 <p>2518-B 25</p> <ul style="list-style-type: none"> 2521-B 25 (50%) 2529-B 25 (50%) 	 <p>25004-B 25</p> <ul style="list-style-type: none"> 2508-A 25 (50%) 2505-A 25 (50%)
 <p>25003-B 25</p> <ul style="list-style-type: none"> 2562-B 25 (49%) 2508-A 25 (51%) 	 <p>25001-C 25</p> <ul style="list-style-type: none"> 2503-D 25 (16%) 2510-A 25 (34%) 2505-A 25 (50%) 	 <p>2577-C 25</p> <ul style="list-style-type: none"> 2503-D 25 (50%) 2505-A 25 (50%) 	 <p>25002-C 25</p> <ul style="list-style-type: none"> 2562-B 25 (30%) 2505-A 25 (45%) 2521-B 25 (25%)
 <p>2578-B 25</p> <ul style="list-style-type: none"> 2545-A 25 (50%) 2542-B 25 (50%) 	 <p>25010-D 25</p> <ul style="list-style-type: none"> 2502-A 25 (42%) 2529-B 25 (18%) 2507-A 25 (29%) 2545-A 25 (11%) 	 <p>25011-D 25</p> <ul style="list-style-type: none"> 2585-B 25 (57%) 2545-A 25 (13%) 2526-B 25 (30%) 	

Tramo Section 0,5m

2,50m

1				
2				
3				
4				
5				
6				
7				
8				

Rock	Azul	Gris	Marrón
Zafiro 25 Ocean 25	Azur 25 Perla 25	2545-A 25 Especial 25 2503-D 25	2545-A 25 2560-A 25 2516-B 25 2501-B 25
		2551-A 25 2511-A 25	2576-B 25 2504-A 25

Custom Collections

Bespoke, just for you.

Collections to create your dream pool. Mosaic solutions that adapt to you and your space, allowing you to combine our mosaics to build a pool that matches your style and vision.

A medida, en exclusiva para ti.

Unas colecciones que traducen tus sueños y los hace realidad. Soluciones en mosaico que se adaptan a ti y a tu espacio, permitiéndote personalizar y combinar nuestros mosaicos para construir tu piscina a tu estilo, a tu manera.

Sur mesure, exclusivement pour vous.

Des collections qui traduisent vos rêves et les réalisent. Des solutions de mosaïque qui s'adaptent à vous et à votre espace, vous permettant de personnaliser et de combiner nos mosaïques pour construire votre piscine dans votre style, à votre façon.



50% Jade + 50%Coral

Custom Mix

At Ezarri, you can create your own blend of mosaics. Visit the Mix Generator on the Ezarri website to mix and match our mosaic tiles to your heart's delight.

Find the winning combination that works for you.

En ezarri, te damos la oportunidad de que generes tu propia mezcla de mosaicos. Visita el Generador de Mezclas de nuestra página web, y combina nuestras referencias como quieras.

¿El resultado? La mezcla de mosaicos perfecta para ti.

Chez Ezarri, nous vous donnons la possibilité de réaliser votre propre mélange de mosaïques. Visitez le Générateur de Mélanges sur notre site Web et combinez nos références à votre guise.

Le résultat ? Le mélange de mosaïque parfait pour vous.

Mix generator

ezarri.com/en/mix-generator



Try our mosaic mix generator in our website

Pruebe nuestro generador de mezclas de mosaicos en nuestra web.

Essayez notre générateur de mélanges de mosaïques sur notre site web.

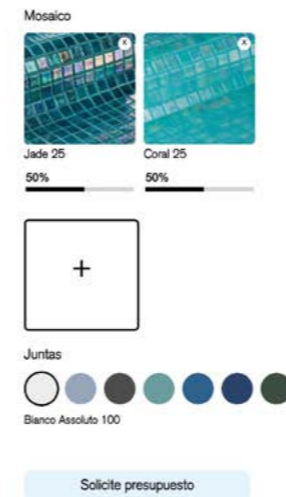

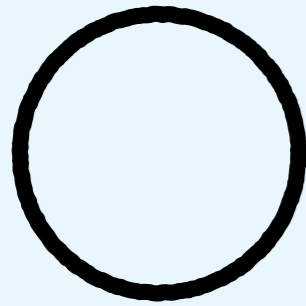

Original Image

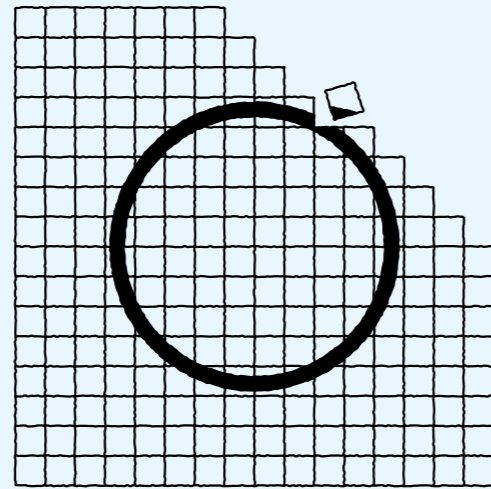

Adaptation to printed mosaic:
The image is printed on the mosaic.

Custom Printed Mosaic

We print your favourite photo or image on mosaic. Create customised art by simply sending us an image and Ezarri will turn it into a faithful reproduction on mosaic. This system maintains the properties of the mosaic, so it can be installed with absolute confidence in all types of settings: swimming pools, spas, showers, kitchens, bathrooms...

Resulting in exclusive projects to suit each individual need.

Imprimimos sobre mosaico tu foto o imagen favorita. Es tan sencillo como enviarnos la imagen con la que quieras personalizar tu proyecto y en Ezarri la plasmaremos sobre mosaico, reproduciendo fielmente la imagen elegida. Este sistema mantiene las propiedades del mosaico, por lo que puede colocarse con absoluta confianza en todo tipo de ambientes: piscinas, spas, duchas, cocinas, aseos...

El resultado, proyectos exclusivos al gusto de cada uno.

Nous imprimons votre photo ou image préférée sur la mosaïque. C'est aussi simple que de nous envoyer l'image avec laquelle vous souhaitez personnaliser votre projet et Ezarri la capturera sur mosaïque, reproduisant fidèlement l'image choisie. Ce système conserve les propriétés de la mosaïque, de sorte qu'il peut être placé en toute confiance dans tous les types d'environnements: piscines, spas, douches, cuisines, toilettes ...

Le résultat, des projets exclusifs au goût de chacun.



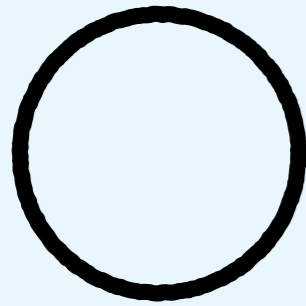

Original Image

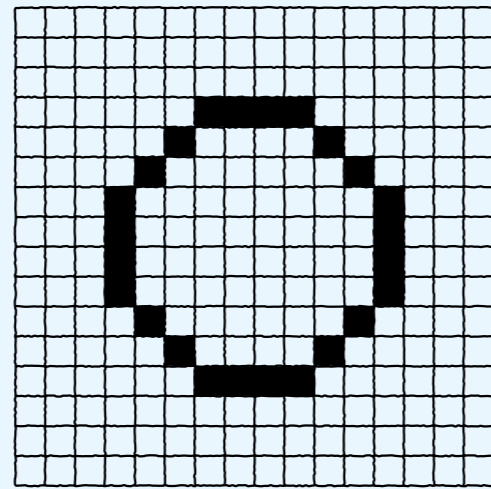

Pixel mosaic adaptation:
The image is created pixel by pixel with the mosaics.

Custom Pixel Mosaic

One mosaic, one pixel. Designs based on an image to personalise the space 100%. A system especially suitable for simple images, repeating patterns or geometric shapes. The greatest advantage: being able to mix various mosaic finishes and textures, such as pearly, smooth, metallic, etc, to make your project truly special and unique.

Cada mosaico, un pixel. Propuestas diseñadas a partir de una imagen para personalizar el espacio al 100%. Un sistema especialmente indicado para imágenes sencillas, patrones repetitivos o formas geométricas. Su mejor ventaja: la posibilidad de mezclar múltiples acabados y texturas de mosaico como nacarados, lisos, metalizados, etc, para hacer de tu proyecto algo absolutamente especial y único.

Chaque mosaïque, un pixel. Propositions conçues à partir d'une image pour personnaliser l'espace à 100%. Un système particulièrement adapté aux images simples, aux motifs répétitifs ou aux formes géométriques. Son plus grand avantage: la possibilité de mélanger plusieurs finitions et textures de mosaïque telles que nacrées, lisses, métallisées, etc., pour faire de votre projet quelque chose d'absolument spécial et unique.



Standard Mosaic

Printed Mosaic



Dolphin Family
257x147 cm



Happy Dolphins
220x257 cm



Sea View
110x110 cm

Pixel Mosaic



D-17
255x128 cm



D-15
255x146 cm



D-2
210x73 cm



D-13
417x263 cm



D-42
292 x 292 cm



D-18
206x206 cm



D-56
250x250 cm



D-9
156x203 cm



Cenefa 1
2545-A 2543-D



Cenefa 6
2508-A 2503-D

Epoxy Joints

Ezarri considers joints to be an essential element within its colorful designs. The aesthetic component of the joint used is very important and when combined with the ezarri mosaic tile ranges can give surprising results. By combining different colored tiles and joints we have been able to develop a new range of color schemes to offer our clients.

In technical terms, ezarri recommends the use of epoxy joints mortars. Apart from offering a wide range of colors and effects such joints have excellent technical specifications; they are damp-resistant, water-repellant, and have great durability. Moreover, this type of joint does not absorb stains, offering total cleanliness and hygiene.

The use of epoxy joints is linked to the use of specific tools and finishing products, both of which are also supplied by ezarri. We recommend you use these specific tools and products in order to ensure a perfect finish and results.

Ezarri hace de las juntas un elemento esencial en sus propuestas de colorido. El componente estético de las juntas es importantísimo y conjugándolo con las colecciones de mosaico ezarri, dan unos resultados sorprendentes. La combinación de colores entre mosaico y junta nos ha permitido desarrollar una propuesta cromática que ponemos a disposición de nuestros clientes.

Técnicamente hablando, ezarri aconseja la utilización de juntas epóxicas. Además de contar con una amplia gama de colores y efectos, estas juntas tienen unas características técnicas excelentes; son insensibles a la humedad, repelen el agua y ofrecen una gran durabilidad. Además, las manchas no penetran en la junta por lo que la limpieza e higiene son totales.

La utilización de juntas epóxicas va vinculada a la utilización tanto de herramientas específicas, como de productos de finalización de obra. Ambos son suministrados también por ezarri. Recomendamos la utilización de estas herramientas y productos específicos para que la finalización y el resultado de la obra sean idóneos.

Pour ezarri, les joints sont un élément essentiel dans ses propositions de coloris. Le composant esthétique des joints est déterminant et leur mélange avec les collections de mosaïque ezarri fournit des résultats réellement suprenants. La combinaison des couleurs de la mosaïque ezarri nous a permis de développer une offre chromatique que nous mettons à la disposition de nos clients.

D'un point de vue technique, ezarri recommande d'utiliser des joints époxy. Leur gamme de couleurs et d'effets est très large et ils possèdent d'excellentes caractéristiques techniques: ils sont insensibles à l'humidité, repoussent l'eau et fournissent une grande durabilité. D'autre part, les taches ne pénètrent pas dans le joint, ce qui permet un nettoyage et une hygiène absolument parfaits.

La mise en place de joints époxy implique l'utilisation d'outils spécifiques et de produits finisseurs. L'ensemble est fourni par ezarri. Nous conseillons vivement d'utiliser tous ces éléments pour que les finitions et le résultat de l'ouvrage soient optimaux.

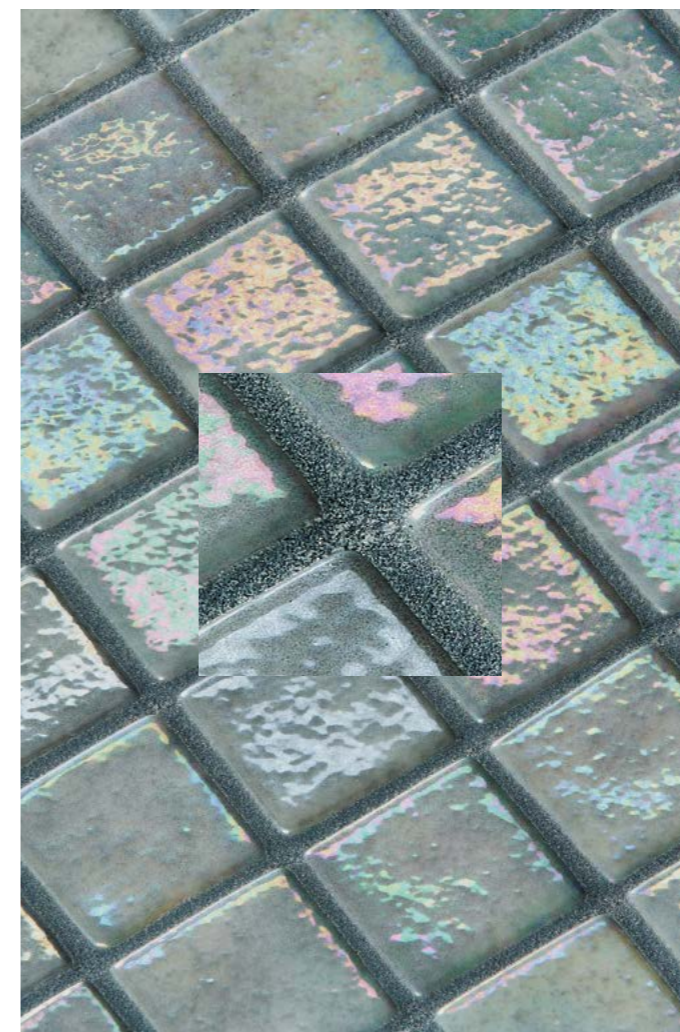



Think big

If you would like to see how our mosaics would work for your large-scale project, spa, hotel, wellness centre or hotel, don't hesitate to contact us and we'll send you our Large Projects catalogue.

Si tienes un proyecto a gran escala, un spa, hotel, wellness o alojamiento en el que quieras ver nuestro mosaico, no lo dudes, habla con nosotros y te enviaremos nuestro catálogo de Large Projects.

Si vous avez un projet d'envergure, un spa, un hôtel, un bien-être ou un hébergement où vous souhaitez voir notre mosaïque, n'hésitez pas, parlez avec nous et nous vous enverrons notre catalogue de Large Projects.

Technical Information

Información técnica

Information Technique

Data Sheets

ezarri.com/en/data-sheets



Ezarri makes Data Sheets of all its collections available to its customers.

Ezarri pone a disposición de sus clientes las fichas de producto de todas sus colecciones.

Ezarri met à la disposition de ses clients les fiches produits de toutes ses collections.

Certifications

ezarri.com/en/certifications



Quality Certifications

ISO 9001 quality certificate, which recognises the robustness and effectiveness of our quality management system and our commitment to continuous improvement.



Certificaciones de Calidad

Certificado de calidad ISO 9001, que reconoce la madurez y eficacia de nuestro sistema de gestión de calidad y nuestro compromiso con la mejora continua.



Certifications de Qualité

Certificat de qualité ISO 9001, qui reconnaît la maturité et l'efficacité de notre système de gestion de la qualité et notre engagement envers une amélioration continue.



Environmental Certifications

We have the ISO 14021 environmental product certification. We use 100% recycled glass for our mosaic tile.



Certificaciones Medioambientales

Contamos con la certificación medioambiental de producto ISO 14021. El 100% del vidrio que utilizamos como materia prima es vidrio reciclado.



Certifications Environnementales

Nous avons la certification environnementale de produit ISO 14021. 100% du verre que nous utilisons comme matière première est du verre recyclé.



Warranty on mosaics

Ezarri, subject to the terms and conditions herein, ensures the purchaser that its glass mosaics are free from manufacturing defects.

Garantía de mosaicos

Ezarri, con sujeción a los términos y condiciones aquí previstos, garantiza al comprador que sus mosaicos de vidrio están libres de defectos de fabricación.

Garantie des mosaïques

Ezarri, sous réserve des termes et conditions énoncés dans les présentes, garantit à l'acheteur que ses mosaïques de verre sont exemptes de défauts de fabrication.

Contact us

Do you want to know more?
ezarri.com

Operadora: (+34) 943 164 140
Comercial España & Portugal: (+34) 943 164 800
Export Sales Agent: (+34) 943 164 801
Commercial France: (+34) 943 164 802

Installation

ezarri.com/en/installation-mosaic-on-concrete



For optimal installation of mosaic tile, Ezarri recommends following the steps in the installation tutorial corresponding to the type of swimming pool:

Para conseguir una óptima instalación del mosaico, Ezarri recomienda seguir los pasos del siguiente tutorial de instalación, en función del tipo de piscina:

Pour obtenir une installation optimale de la mosaïque, Ezarri recommande de suivre les étapes du tutoriel d'installation suivant, en fonction du type de piscine:

Concrete

Hormigón

Béton

Galvanised steel

Acero Galvanizado

Acier galvanisé

Polystyrene

Poliestiereno

Polystyrène

Polypropylene

Polipropileno

Polypropylène

Polyester

Poliester

Polyester

info@ezarri.com

Zubierreka Industrialdea 58
20210 Lazkao (Gipuzkoa) Spain

**Dreams
are made
of mosaics**

ezarri

ezarri.com