



BUILD

CATÁLOGO CONSTRUCCIÓN

CONSTRUCTION CATALOGUE
CATALOGUE DE CONSTRUCTION

V.5

Future needs tools

V.5

CATÁLOGO CONSTRUCCIÓN

CONSTRUCTION CATALOGUE

CATALOGUE DE CONSTRUCTION

ÍNDICE

Index

O1. DISTANCIADORES PAVIMENTO Y REVESTIMIENTO

Wall and floor spacers

Espaceurs sol et mur

pag. 02

O2. HERRAMIENTAS Y ACCESORIOS

Tools and accessories

Outils et accessoires

pag. 09

O3. PLOTS: SOPORTES PARA SUELOS ELEVADOS

Pedestals: Supports for elevated floors

Plots: Supports pour sols surélevés

pag. 12

O4. FACHADA Y PAVÉS

Facade and glass block spacer

Façade et entretoise

pag. 18

O5. ACCESORIOS DE SEGURIDAD

Safety accessories

Accessoires de sécurité

pag. 20

O6. ACCESORIOS PARA ENCOFRADO

Formwork accessories

Accessoires pour coffrage

pag. 22



01. DISTANCIADORES PAVIMENTO Y REVESTIMIENTO

Wall and floor spacers
 Espaceurs sol et mur

CRUCETAS

Tile spacer / Croisillons



Grandes formatos
 Big sizes
 Grand formats



Alta resistencia
 High strength
 Haute resistance

Modo de uso
 Mode of use
 Mode d'utilisation



OPCIONAL
 Optional
 Optionnel

*CRUCETAS EXPOSITOR
 Tile spacer stand
 Présentoir des produits



CRUCETAS

Tile spacer / Croisillons

Código Code	Medidas Sizes / Mesures	Uds. bolsa Units bag / Unités sachet	Uds. caja Units pack / Unités pack	Cajas palet Packs pallet
910005	1 mm - 1/32"	500	60 bolsas / 30.000	30
910012	1,5 mm - 1/16"	500	60 bolsas / 30.000	30
910029	2 mm - 3/32"	500	60 bolsas / 30.000	20
910036	3 mm - 1/8"	500	60 bolsas / 30.000	20
910043	4 mm - 5/32"	300	45 bolsas / 13.500	20
910050	5 mm - 3/16"	300	45 bolsas / 13.500	20
910067	7 mm - 9/32"	300	20 bolsas / 6.000	20
910074	10 mm - 13/32"	100	30 bolsas / 3.000	20
910081	15 mm - 19/32"	100	12 bolsas / 1.200	42
912009	Cuña 1-5 mm	300	100 bolsas / 30.000	30



910005



910012



910029



910036



910043



910050



910067



910074



910081



912009

SISTEMA DE NIVELACIÓN

Levelling system / Système de nivellement



913839:
Pack expositor
Display stand
Présentoir

Modo de uso
Mode of use
Mode d'utilisation



Calculadora de bases
Bases calculator
Calculateur de bases



H: 3-12 mm BASE NIVELACIÓN

Levelling base / Base de nivellement

Código Code	Medidas Sizes / Mesures	Uds. bolsa Units bag / Unités sachet	Uds. caja Units pack / Unités pack	Cajas palet Packs pallet
913969	Base 0,5 mm - 1/64"	100	35 bolsas / 3.500 uds. caja	20
912504		250	14 bolsas / 3.500 uds. caja	20
912603		250 Poliamida	14 bolsas / 3.500 uds. caja	20
913983		500	7 bolsas / 3.500 uds. caja	20
913006	Base 1 mm - 1/32"	100	35 bolsas / 3.500 uds. caja	20
913013		250	14 bolsas / 3.500 uds. caja	20
912610		250 Poliamida	14 bolsas / 3.500 uds. caja	20
913020		500	7 bolsas / 3.500 uds. caja	20
913914	Base 1,5 mm - 1/16"	100	35 bolsas / 3.500 uds. caja	20
913921		250	14 bolsas / 3.500 uds. caja	20
913938		500	7 bolsas / 3.500 uds. caja	20
913037	Base 2 mm - 3/32"	100	35 bolsas / 3.500 uds. caja	20
913044		250	14 bolsas / 3.500 uds. caja	20
913051		500	7 bolsas / 3.500 uds. caja	20
913068	Base 3 mm - 1/8"	100	35 bolsas / 3.500 uds. caja	20
913075		250	14 bolsas / 3.500 uds. caja	20
913082		500	7 bolsas / 3.500 uds. caja	20
912641	Base 4 mm - 5/32"	100	35 bolsas / 3.500 uds. caja	20
912658		250	14 bolsas / 3.500 uds. caja	20
912665		500	7 bolsas / 3.500 uds. caja	20
912672	Base 5 mm - 3/16"	100	35 bolsas / 3.500 uds. caja	20
912689		250	14 bolsas / 3.500 uds. caja	20
912696		500	7 bolsas / 3.500 uds. caja	20

913839

Pack expositor: 48 bolsas de 1mm 250uds/bolsa - 60 bolsas de cuña ancha 100uds/bolsa - 6 alicates metálicos
Display stand: 48 bags of 1mm 250 pcs/bag - 60 bags of wide wedge 100 pcs/bag - 6 metal pliers
Présentoir : 48 sachets de 1mm 250 pcs/sac - 60 sachets de cale large 100 pcs/sac - 6 pinces métalliques



H: 12-20mm BASE ALTA

High base / Haute bride

Código Code	Medidas Sizes / Mesures	Uds. bolsa Units bag / Unités sachet	Uds. caja Units pack / Unités pack	Cajas palet Packs pallet
913341	1 mm - 1/32"	250	12 bolsas / 3.000 uds. caja	16
913372	2 mm - 3/32"	250	12 bolsas / 3.000 uds. caja	16

*Para otras medidas (3-5mm), consultar.

For other measurements (3-5mm), consult.
Pour d'autres mesures (3-5mm), consulter.



Base slim compatible con rosca (estrecha)
Slim base compatible with levelling thread
Slim bride compatible avec fil de nivellement

NOVEDAD
NEW / NOUVEAUTÉ
DOBLE SISTEMA
DOUBLE SYSTEM / DOUBLE SYSTÈME



Cabeza dentada para uso con rosca
Serrated head for use with thread
Tête dentelée à utiliser avec écrou



H: 3-14mm **BASE SLIM COMPATIBLE CON ROSCA / CUÑA (ESTRECHA)**
Slim base compatible with levelling thread / slim wedge
Slim bride compatible avec filetage / cale slim

Código Code	Medidas Sizes / Mesures	Uds. bolsa Units bag / Unités sachet	Uds. caja Units pack / Unités pack	Cajas palet Packs pallet
913518	Base 0,5 mm - 1/64"	100	30 bolsas / 3.000 uds. caja	16
913525		250	12 bolsas / 3.000 uds. caja	16
913532		500	6 bolsas / 3.000 uds. caja	16
913099	Base 1 mm - 1/32"	100	30 bolsas / 3.000 uds. caja	16
913105		250	12 bolsas / 3.000 uds. caja	16
913112		500	6 bolsas / 3.000 uds. caja	16
913129	Base 1,5 mm - 1/16"	100	30 bolsas / 3.000 uds. caja	16
913136		250	12 bolsas / 3.000 uds. caja	16
913143		500	6 bolsas / 3.000 uds. caja	16
913150	Base 2 mm - 3/32"	100	30 bolsas / 3.000 uds. caja	16
913167		250	12 bolsas / 3.000 uds. caja	16
913174		500	6 bolsas / 3.000 uds. caja	16
913181	Base 3 mm - 1/8"	100	30 bolsas / 3.000 uds. caja	16
913198		250	12 bolsas / 3.000 uds. caja	16
913204		500	6 bolsas / 3.000 uds. caja	16



H: 3-14 mm **BASE COMPATIBLE CON ROSCA / CUÑA**
Base compatible with levelling wedge/thread / Base compatible avec cale/filetage

Código Code	Medidas Sizes / Mesures	Uds. bolsa Units bag / Unités sachet	Uds. caja Units pack / Unités pack	Cajas palet Packs pallet
913549	Base 0,5 mm - 1/64"	100	30 bolsas / 3.000 uds. caja	16
913556		250	12 bolsas / 3.000 uds. caja	16
913563		500	6 bolsas / 3.000 uds. caja	16
913211	Base 1 mm - 1/32"	100	30 bolsas / 3.000 uds. caja	16
913228		250	12 bolsas / 3.000 uds. caja	16
913235		500	6 bolsas / 3.000 uds. caja	16
913242	Base 1,5 mm - 1/16"	100	30 bolsas / 3.000 uds. caja	16
913259		250	12 bolsas / 3.000 uds. caja	16
913266		500	6 bolsas / 3.000 uds. caja	16
913273	Base 2 mm - 3/32"	100	30 bolsas / 3.000 uds. caja	16
913280		250	12 bolsas / 3.000 uds. caja	16
913297		500	6 bolsas / 3.000 uds. caja	16
913303	Base 3 mm - 1/8"	100	30 bolsas / 3.000 uds. caja	16
913310		250	12 bolsas / 3.000 uds. caja	16
913327		500	6 bolsas / 3.000 uds. caja	16

ACCESORIOS DE NIVELACIÓN

Levelling system accessories / Accessoires de mise à niveau



Rosca de nivelación. Fácil y de uso muy sencillo, pensado para ahorrar costes y tiempo. Reutilizable. Rotura perfecta y limpia, sin necesidad del uso de cuñas.

The levelling thread is a new system patented by Tayg Build, in which, we are looking for the easier and quicker installation of the tile bases, through the manual adjust by screwing, ensuring the levelling and getting the correct planimetry on the installation.

Fil de nivellement. C'est un nouveau système breveté par Tayg Build, avec lui, on recherche une installation plus commode et rapide de la céramique à travers l'ajustement manuel vissé qui assure le nivellement et la parfaite planimétrie de la pose.

ROSCA

Thread / Écrou

Código Code	Uds. bolsa Units bag / Unités sachet	Uds. caja Units pack / Unités pack	Cajas palet Packs pallet
913495	50	24 bolsas / 1.200 uds. caja	16
913501	100	12 bolsas / 1.200 uds. caja	16



ALICATE METÁLICO*

Metallic plier / Pince métallique

Código Code	Uds. bolsa Units bag / Unités sachet	Uds. caja Units pack / Unités pack	Cajas palet Packs pallet
913471	1	6	-



ALICATE PLÁSTICO - INTERIOR METAL (PROFESIONAL)

Plastic plier - inside metal (PROFESSIONAL)/ Pince plastique - métal intérieur (PROFESSIONNEL)

Código Code	Uds. bolsa Units bag / Unités sachet	Uds. caja Units pack / Unités pack	Cajas palet Packs pallet
913860	1	6	-



*Los alicates son compatibles tanto para base estrecha como para base ancha.

The pliers are able to use it with wide base or slim base.

Les pinces sont compatibles pour les bases étroites comme pour les bases larges

Cuña profesional milimetrada. Apta para colocación manual.

Professional measuring tip. Suitable for manual installation.

Cône professionnel millimétré. Approprié pour la pose manuelle



CUÑA SLIM (ESTRECHA) MILIMETRADA 13mm

SLIM wedge measuring (slim) 13 mm / Cale SLIM millimétrée (étroite) 13 mm

Código Code	Uds. bolsa Units bag / Unités sachet	Uds. caja Units pack / Unités pack	Cajas palet Packs pallet
913396	100	20 bolsas / 2.000 uds.caja	16
913402	250	8 bolsas / 2.000 uds. caja	16
913419	500	4 bolsas / 2.000 uds. caja	16



CUÑA PROFESIONAL MILIMETRADA 22mm

Professional measuring wedge 22mm / Cale professionnelle millimétrée 22mm

Código Code	Uds. bolsa Units bag / Unités sachet	Uds. caja Units pack / Unités pack	Cajas palet Packs pallet
913426	100	20 bolsas / 2.000 uds.caja	16
913433	250	8 bolsas / 2.000 uds. caja	16
913440	500	4 bolsas / 2.000 uds. caja	16



Modo de uso
Mode of use
Mode d'utilisation



MODO DE USO

Mode of use / Comment utiliser

En primer lugar limpiar la superficie para una correcta colocación, además de ajustar el alicate según el espesor del material.

First clean the surface for correct placement, furthermore adjust the pliers according to the thickness.

Commencez par nettoyer la surface pour une pose correcte, puis ajuster la pince selon l'épaisseur du carrelage.

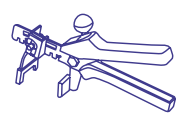

1. Colocar bases / Place the base / Placer les bases



2. Macear ligeramente / Tap gently / Taper légèrement



3. Introducir cuñas / Introduce the wedges / Introduire les cales



4. Apretar / Tighten / Serrer



5. Esperar secado / Allow for setting / Attendre que cela sèche



6. Retirar sistema / Remove the system / Retirer le système

TAYG ROLL

Tayg Roll / Tayg Roll



BASE TAYG ROLL

Tayg Roll base / Base Tayg Roll

Código Code	Medidas Sizes / Mesures	Uds. bolsa Units bag / Unités sachet	Uds. caja Units pack / Unités pack	Cajas palet Packs pallet
915208	Base 1 mm - 1/32"	200	20 bolsas / 4.000 uds. caja	20
915215	Base 1,5 mm - 1/16"	200	20 bolsas / 4.000 uds. caja	20
915222	Base 2 mm - 3/32"	200	20 bolsas / 4.000 uds. caja	20
915239	Base 3 mm - 1/8"	200	20 bolsas / 4.000 uds. caja	20



ROSCA TAYG ROLL

Tayg Roll thread / Filetage Tayg Roll

Código Code	Uds. bolsa Units bag / Unités sachet	Uds. caja Units pack / Unités pack	Cajas palet Packs pallet
915246	100	15 bolsas / 1.500 uds. caja	20



PROTECTOR TAYG ROLL

Tayg Roll protector / Protecteur Tayg Roll

Código Code	Uds. bolsa Units bag / Unités sachet	Uds. caja Units pack / Unités pack	Cajas palet Packs pallet
915253	100	50 bolsas / 5.000 uds. caja	20

KIT TAYG ROLL (150 bases + 50 roscas)

Tayg Roll kit (150 bases + 50 thread) / Kit Tayg Roll (150 bases + 50 filetage)

Código Code	Medidas Sizes / Mesures	Uds. caja Units pack / Unités pack	Cajas palet Packs pallet
915260	Base 1 mm - 1/32"	12 bolsas / bags / sachets	20
915277	Base 1,5 mm - 1/16"	12 bolsas / bags / sachets	20
915284	Base 2 mm - 3/32"	12 bolsas / bags / sachets	20
915291	Base 3 mm - 1/8"	12 bolsas / bags / sachets	20









O2. HERRAMIENTAS Y ACCESORIOS

Tools and accessories

Outils et accessoires

HERRAMIENTAS

Tools / Outils

Código Code		Descripción Description / Description	Tamaño Measure / Mesure	Uds. caja Units pack / Unités pack
920028		Talocha esponja 30mm Sponge float 30mm / Taloché éponge 30mm	280 x 140	10
920035		Talocha esponja intermedia Sponge float intermediate / Taloché éponge moyenne	280 x 140	10
920042		Esponja de limpieza Cleaning sponge / Éponge classique	200 x 125 x 70	12
920059		Llana regular inox lisa Rectangular stainless-steel trowel / Truelle rectangulaire inox lisa	300 x 140	12
920066		Llana dentada inox 8mm Notched stainless-steel trowel 8 mm / Truelle dentelé inox 8 mm	300 x 150	12
920073		Llana dentada inox 10mm Notched stainless-steel trowel 10 mm / Truelle dentelé inox 10 mm	300 x 150	12
920080		Talocha rejuntado Rubber float / Taloché à joint	240 x 95	10



PACK CUBO REJUNTADO 15L (CUBO + TALOCHA HIDRO + TALOCHA GOMA + RODILLOS)

Grout bucket pack 15L (bucket + hydro float + rubber float + rollers)

Bac de nettoyage de joint 15L (seau + taloché hydro + taloché caoutchouc + rouleaux)

Código
Code

920011

Uds. caja
Units pack / Unités pack

1

ACCESORIOS

Accessories / Accessoires

CINTURONES Y SOPORTES DE CUERO

Leather belts and holders / Ceintures et supports en cuir

Código Code	Modelo Model / Modèle	UNIDADES EMBALAJE Packing units / Unités d'emballage
086601	Cinturón soporte simple Simple hold belt Ceintura support simple	10
087608	Cinturón soporte profesional Professional hold belt Ceintura support professionnel	10

Material: Cuero natural

Material: Natural leather / Matériau: Cuir naturel



086601: 5 compartimentos
5 compartments / 5 compartiments

087608: 11 compartimentos
11 compartments / 11 compartiments

COFRE HERRAMIENTAS MÓVIL 51

Mobile tool chest No. 51 / Coffre a outils mobile 51

Código Code	L x A x H		UNIDADES EMBALAJE Packing units / Unités d'emballage
	Medidas Sizes / Mesures		
151002	675 x 472 x 416 mm 26,57 x 18,58 x 16,38 in		1

Contiene: 2 bandejas + 2 estuches

Contained: 2 trays + 2 organizers / Contient: 2 panier porte-outils + 2 coffrets

Material: PP

Material: PP / Matériau: PP



x2



Soporta 120kg

Supports up to 120kg

Supporte 120kg

BIDONES CON GRIFO

Jerry cans with tap / Jerrican avec robinet

Código Code	L x A x H		UNIDADES EMBALAJE Packing units / Unités d'emballage
	Capacidad Capacity / Capacité	Medidas Sizes / Mesures	
601361	5L	230 x 145 x 257 mm	6
602368	10L	265 x 200 x 307 mm	6
603365	20L	345 x 234 x 377 mm	5
604362	30L	400 x 237 x 464 mm	5



Material: HDPE

Material: HDPE / Matériau: HDPE

Toma de aire para un vertido uniforme
Air intake for uniform pouring / Prise d'air pour une décharge uniforme

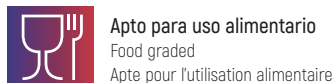

Apto para uso alimentario

Food graded

Apte pour l'utilisation alimentaire

BIDONES CON CÁNULA / COMBUSTIBLE

Jerry cans with spout/fuel / Bidons avec bec/carburant

Código Code	L x A x H		UNIDADES EMBALAJE Packing units / Unités d'emballage
	Capacidad Capacity / Capacité	Medidas Sizes / Mesures	
601354	5L	230 x 145 x 257 mm	6
602351	10L	265 x 200 x 307 mm	6
603358	20L	345 x 234 x 377 mm	5
604355	30L	400 x 237 x 464 mm	5



Con visor
With sight / Avec viseur

Material: HDPE

Material: HDPE / Matériau: HDPE

Toma de aire para un vertido uniforme
Air intake for uniform pouring / Prise d'air pour une décharge uniforme



772603



777608



789601 - 790607



791604-792601

ENROLLACABLES

Cable reels / Enrouleur

Código Code	Pot. máxima Max Power / Puissance maximale	Bases Sockets / Entrées	Cable Cable	Diámetro de carrete Spool diameter / Diamètre de la bobine	UNIDADES EMBALAJE Packing units / Unités d'emballage
772603	250 V ~ 16A 4.000W	4 (2P+T) con termostato IP20 4 (2P+T) with thermostat IP20 4 (2P+T) avec thermostat IP20	H05VV-F 3G1,5 25M	210 mm	1
777608	250 V ~ 16A 4.000W	4 (2P+T) con termostato IP20 4 (2P+T) with thermostat IP20 4 (2P+T) avec thermostat IP20	H05VV-F 3G1,5 50M	270 mm	1
789601	250 V ~ 3.500W	3 (2P+T) con termostato y tapa IP55 3 (2P+T) with thermostat and cover IP55 3 (2P+T) avec thermostat et couvercle IP55	H05RR-F 3G1,5 25M (goma)	290 mm	1
790607	250 V ~ 3.500W	3 (2P+T) con termostato y tapa IP55 3 (2P+T) with thermostat and cover IP55 3 (2P+T) avec thermostat et couvercle IP55	H05RR-F 3G1,5 50M (goma)	290 mm	1
791604	250 V ~ 3.500W	3 (2P+T) con termostato y tapa IP55 3 (2P+T) with thermostat and cover IP55 3 (2P+T) avec thermostat et couvercle IP55	H07RN-7 3G1,5 25M	270 mm	1
792601	250 V ~ 3.500W	3 (2P+T) con termostato y tapa IP55 3 (2P+T) with thermostat and cover IP55 3 (2P+T) avec thermostat et couvercle IP55	H07RN-7 3G2,5 25M	290 mm	1

- Tiempo de trabajo 2h**
Work time 2h / Temps de travail 2h
- Tiempo de carga 4-5h**
Charging time 4-5h / Temps de charge 4-5h
- Micro USB 1 m**
- Recargable USB**
Rechargeable usb / Rechargeable par USB
- Ángulo de haz**
Beam angle / Angle de faisceau
120°
- LED**
- SMD**
- 6500° K**
LUZ BLANCA · WHITE LIGHT · LUMIÈRE BLANCHE · LUMIÈRE BLANCHE

515606
516603

4 h

4,5 h
700lm - 2,5h - 1,5h
1200lm - 2000lm

REGULABLE

4000K - 6500K

LED

120°

ÁNGULO DE HAZ · BEAM ANGLE
ANGLE DE FAISCEAU

WATERPROOF
IP54
PROTECTION

Micro USB

On / Off

USB

RECHARGABLE

523601

WATERPROOF
IP65
PROTECTION

LED

6500° K

LUZ BLANCA · WHITE LIGHT · LUMIÈRE BLANCHE · LUMIÈRE BLANCHE

517600

518607

PROYECTORES LED
Led worklight / Projecteur led

L x A x H

Código Code	Pot. máxima Max Power / Puissance maximale	Voltaje Voltage / Tension	Cable Cable	Medidas Sizes / Mesures	UNIDADES EMBALAJE Packing units / Unités d'emballage
515606	Soporte 30W - 2400Lm	220-240V ~ 50-60Hz	H05RN-F 3G 1,0mm² 1,5m	220 x 205 x 315 mm	8
516603	Soporte 50W - 4000Lm	220-240V ~ 50-60Hz	H05RN-F 3G 1,0mm² 1,5m	295 x 210 x 365 mm	4
523601	Tripode 20W triple	220-240V	RECHARGABLE	550 x 550 x 1460 mm	4
517600	Tripode 50W - 4000Lm	220-240V ~ 50-60Hz	H05RN-F 3G 1,0mm² 2,5m	800 x 800 x 1455 mm	4
518607	Tripode 2 x 50W 8000Lm	220-240V ~ 50-60Hz	H05RN-F 3G 1,0mm² 3m	860 x 860 x 1925 mm	4



O3. PLOTS: SOPORTES PARA SUELOS ELEVADOS

Pedestals: Supports for elevated floors

Plots: Supports pour sols surélevés

EL NUEVO SISTEMA DE SUELOS ELEVADOS DE TAYG BUILD

The new raised flooring system

Le nouveau système de plancher surélevé de tayg build

BENEFICIOS Y CARACTERÍSTICAS:

Advantages and characteristics / Avantages et caractéristiques

- **El agua que se filtra** del terreno en las zonas ajardinadas **se puede eliminar fácilmente** / Water seeping from the ground into the landscaped areas can be easily removed / L'eau qui s'infiltré du sol dans les zones aménagées peut être facilement éliminée
- **Alta resistencia a la carga** / High load resistance / Résistance élevée à la charge
- **Fácil y rápido** / Easy and quick / Facile et rapide
- **Puede ajustarse a la altura** especificada en el proyecto / Can be adjusted to the height specified in the project / Peut être ajusté à la hauteur spécifiée dans le projet
- **Elimina las diferencias de la pendiente** / Eliminates slope differences. / Élimine les différences de pente
- **Se puede utilizar por debajo de un suelo temporal** / Can be used under a temporary floor / Peut être utilisé sous un plancher temporaire
- **Sistema de autonivelación** / Self-levelling system / Système d'auto-nivellement
- **Puede instalarse sobre suelo resistente al agua o sobre aislamiento térmico** / Can be installed on water-resistant flooring or on thermal insulation. / Peut être installé sur un revêtement de sol résistant à l'eau ou sur une isolation thermique
- **Se puede aplicar en todas las condiciones meteorológicas** / Can be applied in all weather conditions. / Peut être appliqué dans toutes les conditions météorologiques
- **La iluminación, el cableado, los accesorios y la circulación del agua pueden realizarse bajo el sistema elevado** / Lighting, wiring, fittings and water circulation can be carried out under the elevated system / L'éclairage, le câblage, l'aménagement et la circulation de l'eau peuvent être réalisés sous le système surélevé

ÁREAS DE APLICACIÓN:

Application areas / Domaines d'application

Terrazas, salas eléctricas, recinto ferial, zonas ajardinadas, piscinas, polígonos industriales, balcones / Terraces, electrical halls, fairgrounds, garden areas, swimming pools, industrial estates, balconies / Terrasses, halls électriques, champs de foire, zones de jardin, piscines, zones industrielles, balcons

MATERIALES DE PAVIMENTACIÓN:

Paving materials / Matériaux utilisables sur plots

Tablero de aglomerado, cerámica, mármol, piedra natural, granito, composite Deck, tarima de madera / Chipboard, ceramic, marble, natural stone, granite, composite deck, wooden decking / Panneau de particules, céramique, marbre, pierre naturelle, granit, terrasse composite, terrasse en bois

PLOTS FIJOS

Fixed pedestals / Plots fixes



914829



914836



914843



914850

Modelo Model / Modèle	Código Code	Medidas Sizes/ Mesures	Uds. caja Units pack / Unités pack	Cajas palet Packs pallet
TBF-14	914829	14 mm - 0,55in	260	27
TBF-16	914836	16 mm - 0,63in (tamaño pestaña)	150	27
TBF-20	914843	20 mm - 0,79in	180	27
TBF-30	914850	30 mm - 1,18in	120	27

Apilables
Stackables / Empilable



OPCIONAL: Plots fijos apilables
OPTIONAL: Stackable fixed pedestals / OPTION: Plots fixes empilables

PLOTS REGULABLES

Adjustable pedestals / Plots regables

CÁLCULO PLOTS (SOPORTE ELEVADOS) PARA BALDOSAS

Pedestal calculator / Calculateur de plots

EJEMPLO CÁLCULO:

AREA: 50 m²
BALDOSA: 60 X 60 cm = 3,4 u.
PLOTS: 50 m² X 3,4 u = 170 u.

EXAMPLE CALCULATION:

AREA: 50 m²
TILE: 60 X 60 cm = 3,4 u.
PEDESTAL: 50 m² X 3,4 u = 170 u.

EXEMPLE DE CALCUL:

SURFACE: 50 m²
CARREAUX: 60 X 60 cm = 3,4 u.
PLOTS: 50 m² X 3,4 u = 170 u.

Medidas baldosa cm Tile sizes / Mesures de carreaux	Nº plots/m ² Nº pedestals/m ²	Con plots centrales With central pedestals / avec plots centrales
30 x 30	12,5 uds	
30 x 60	6,5 uds	
40 x 40	6,9 uds	
45 x 45	6,9 uds	
40 x 60	4 uds	
50 x 50	4,5 uds	
60 x 60	3,4 uds	6,3 uds
75 x 75	2,3 uds	4,3 uds
80 x 80	2 uds	3,7 uds
45 x 90		5,8 uds
90 x 90	1,7 uds	3,1 uds
100 x 100		4,5 uds
30 x 120		6,4 uds
40 x 120		4,8 uds
60 x 120		3,4 uds



PLOTS REGULABLES

Adjustable pedestals / Plots regulables



Modelo Model / Modèle	Código Code	Medidas Sizes / Mesures	Uds. caja Units pack / Unités pack	Cajas palet Packs pallet
TBR-1825	914607	18-25 mm	132	25
TBR-2840	914614	28-40 mm	90	25
TBR-3651	914621	36-51 mm	60	25
TBR-5282	914638	52-82 mm	48	25
TBR-83134	914645	83-134 mm	24	25
TBR-133225	914652	133-225 mm	24	25

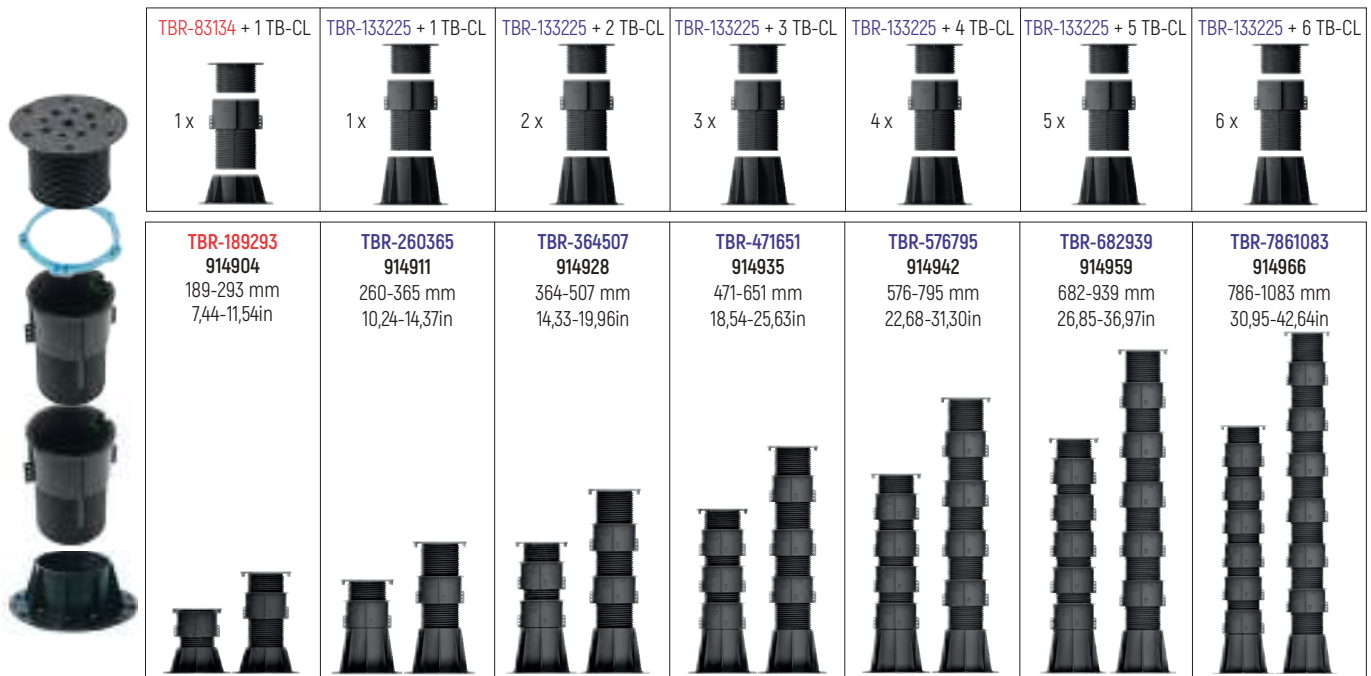

Modelo Model / Modèle	Código Code	Medidas Sizes / Mesures	Nº adaptadores Adapters units / Nombre d'adaptateurs	Uds. caja Units pack / Unités pack	Montaje Assembly / Assemblage	Packing
TBR-189293	914904	189-293 mm	TB-CL 1	24	TBR-83134 x 1 TB-CL	1 x 914645 - 1 x 914669
TBR-260365	914911	260-365 mm	TB-CL 1	24	TBR-133225 x 1 TB-CL	1 x 914652 - 1 x 914669
TBR-364507	914928	364-507 mm	TB-CL 2	24	TBR-133225 x 2 TB-CL	1 x 914652 - 2 x 914669
TBR-471651	914935	471-651 mm	TB-CL 3	24	TBR-133225 x 3 TB-CL	1 x 914652 - 3 x 914669
TBR-576795	914942	576-795 mm	TB-CL 4	24	TBR-133225 x 4 TB-CL	1 x 914652 - 4 x 914669
TBR-682939	914959	682-939 mm	TB-CL 5	24	TBR-133225 x 5 TB-CL	1 x 914652 - 5 x 914669
TBR-7861083	914966	786-1083 mm	TB-CL 6	24	TBR-133225 x 6 TB-CL	1 x 914652 - 6 x 914669

ACCESORIOS GENERALES

General accessories / Accessoires généraux



914690

Amortiguador

Shock absorber / Amortisseur



914669

Adaptador

Height adapter / Rehausse



914683

Contra tuerca

Back thread / Ecrou de blocage



914676

Disco nivelador

Leveling disc / Disque niveleur

Modelo Model / Modèle	Código Code	Medidas Sizes/ Mesures	Uds. caja Units pack / Unités pack	Cajas palet Packs pallet
TB-A	914690	-	40 ud./bolsa - 8 bolsas	128
TB-CL	914669	altura 180mm	24	25
TB-CR	914683	altura 10mm	100	128
TB-DN	914676	desnivel 2%	100	128



914706

Cruceta separador central

Central spacer crosshead
Traverse de séparation centrale



914720

Separador recto

Straight spacer
Séparateur droit



914751

Adaptador rastreles

Tracking adapter
Adaptateur à piston



914744

Adaptador rastreles central

Central tracking adapter
Adaptateur à piston central

ACCESORIOS FIJOS

Fixed accessories / Accessoires fixes

Modelo Model / Modèle	Código Code	Medidas Sizes/ Mesures	Uds. caja Units pack / Unités pack	Cajas palet Packs pallet
TBF-SC3	914706	3 mm - 1/8"	40 ud./bolsa - 13 bolsas	128
TBF-SM3	914720	3 mm - 1/8"	40 ud./bolsa - 25 bolsas	128
TBF-W	914751	-	40 ud./bolsa - 11 bolsas	128
TBF-WH	914744	40-50 mm - 1,57-1,97in	32	128

3mm - 1/8"



914775

Cabeza baldosa autonivelante

Self-leveling tile head
Tête transversale auto-nivelante



914768

Cabezal central autonivelante

Self-levelling central head
Tête centrale auto-nivelante



914805

Cabezal de viga autonivelante

Self-leveling beam heads
Tête pour lambourdes à nivellement automatique



914799

Cabezal de viga autonivelante

Self-leveling beam heads
Tête pour lambourdes à nivellement automatique

Cabezas autonivelantes +20mm de altura

Self-levelling heads +20mm height

Têtes auto-nivelantes +20mm de hauteur

CABEZA AUTONIVELANTE 7% DESNIVEL

Self-levelling head 7% slope / Tête autonivelante 7% de denivelment

Modelo Model / Modèle	Código Code	Medidas Sizes/ Mesures	Uds. caja Units pack / Unités pack	Cajas palet Packs pallet
TBR-TS3	914775	3mm - 1/8"	24	128
TBR-C	914768	Plano	28	128
TBR-WH	914805	Vigas de hasta Beams up to / Poutres jusqu'à 40-50 mm - 1,57-1,97in	20	128
TBR-WHS	914799	Vigas de hasta Beams up to / Poutres jusqu'à 80 mm - 3,15in	20	128

OTROS ACCESORIOS

Other accessories / Autres accesories



914867

Tornillo fijación viento
Central fixing screw
Vis de fixation vent



914812

Separador pared
Wall separator
Séparateur mural



914881

Clip metal arriba
Metal clip on top
Clip métallique en haut



914898

Clip metal abajo
Metal clip on the top
Clip métal en le bas



914874

Llave ajustable
Height adjustable key
Clé de réglable



914973

Hta. taladro
Adapter tool for drill
Outil de forage

Modelo Model / Modèle	Código Code	Uds. caja Units pack / Unités pack
TB-PV	914867	100 ud./bolsa - 5 bolsas
TB-SP	914812	100
TB-MTF	914881	100
TB-MBF	914898	100
TBR-AK	914874	4
TBR-AT	914973	2

TB-PV

Protector contra el viento que evita que el pavimento se levante en caso de fuertes vientos.

Wind protector that prevents the pavement from lifting in strong winds.
Protection contre le vent qui empêche le sol de se soulever en cas de vents forts.



TB-MTF - TB-MBF

Accesorio metálico terminación lateral.
Metal fitting with vertical end edge clamp.
Raccord métallique avec terminaison latérale.

TB-SP

Se puede utilizar con todos nuestros plots. Crea un hueco entre el plot y la pared permitiendo un flujo de agua perfecto, incluso en condiciones meteorológicas adversas (lluvias intensas, nieve, etc.).

Can be used with all our pedestals. It creates a gap between the pedestal and the wall allowing a perfect water flow, even in adverse weather conditions (heavy rain, snow, etc.).

Peut être utilisé avec tous nos Plots. Il crée un espace entre le plot et le mur, ce qui permet un écoulement parfait de l'eau, même en cas de mauvaises conditions météorologiques (fortes pluies, neige, etc.).



TBR-AK

Herramienta. Llave ajustable. Con esta llave conseguimos regular la altura con la cabeza autonivelante. Se puede usar en la instalación finalizada o en el momento de la colocación de las baldosas.

With this key we can adjust the height of the self-levelling head. It can be used during final assembly or when laying tiles.

Cette clé permet de régler la hauteur de la tête autonivelante. Elle peut être utilisée lors du montage final ou lors de la pose de carreaux.

TABLA CÁLCULO PLOTS POR M²

Table calculation pedestals per m² / Tableau calcul plots par m²

Calculadora de plots
Pedestals calculator
Calculateur de plots



	20	30	40	45	50	60	70	75	80	90	100
20	25	16,67	12,5	11,11	10	8,33	14,29	13,33	12,5	11,11	10
30	16,67	11,11	8,33	7,41	6,67	5,56	9,52	8,89	8,33	7,41	6,67
40	12,5	8,33	6,5	5,56	5	4,17	7,14	6,67	6,65	5,56	5
45	11,1	7,41	5,56	4,94	4,44	3,7	6,35	5,63	5,56	4,94	4,44
50	10	6,67	5	4,44	4	3,33	5,71	5,33	5	4,44	4
60	8,3	5,56	4,17	3,7	3,33	3,78	4,76	4,44	4,17	3,7	3,33
70	14,29	9,52	7,14	6,35	5,71	4,76	4,08	3,81	3,57	3,17	2,86
75	13,33	8,89	6,67	5,93	5,33	4,44	3,81	3,56	3,33	2,96	2,67
80	12,5	8,33	6,25	5,56	5	4,17	3,57	3,33	6,25	5,56	5
90	11,11	7,41	5,56	4,94	4,44	3,7	3,17	2,96	5,56	4,94	4,44
100	10	6,67	5	4,44	4	3,33	2,86	2,67	5	4,44	4
120	8,33	5,56	4,17	3,7	3,33	2,78	2,38	2,22	4,17	3,7	3,33
140	14,29	9,52	7,14	6,35	5,71	4,76	2,04	1,9	3,57	3,17	2,86
160	12,5	8,33	6,25	5,56	5	4,17	3,57	3,33	6,25	5,56	5
180	8,33	5,56	4,17	3,7	3,33	2,78	2,38	2,22	4,17	3,7	3,33

Esta tabla es un cálculo matemático y no tiene en cuenta las variables de la construcción, por lo tanto, es orientativo y se recomienda incrementar el valor entre un 5 y 15%

This table is a mathematical calculation and does not take into account the construction variables, therefore it is indicative and it is recommended to increase the above values by 5 to 15%

Ce tableau est un calcul mathématique et ne prend pas en compte les variables de construction, il est donc indicatif et recommandé d'augmenter la valeur entre 5 et 15%

CÁLCULO POR TAMAÑO DE BALDOSA

Calculation by tile size / Calcul par taille de carreaux

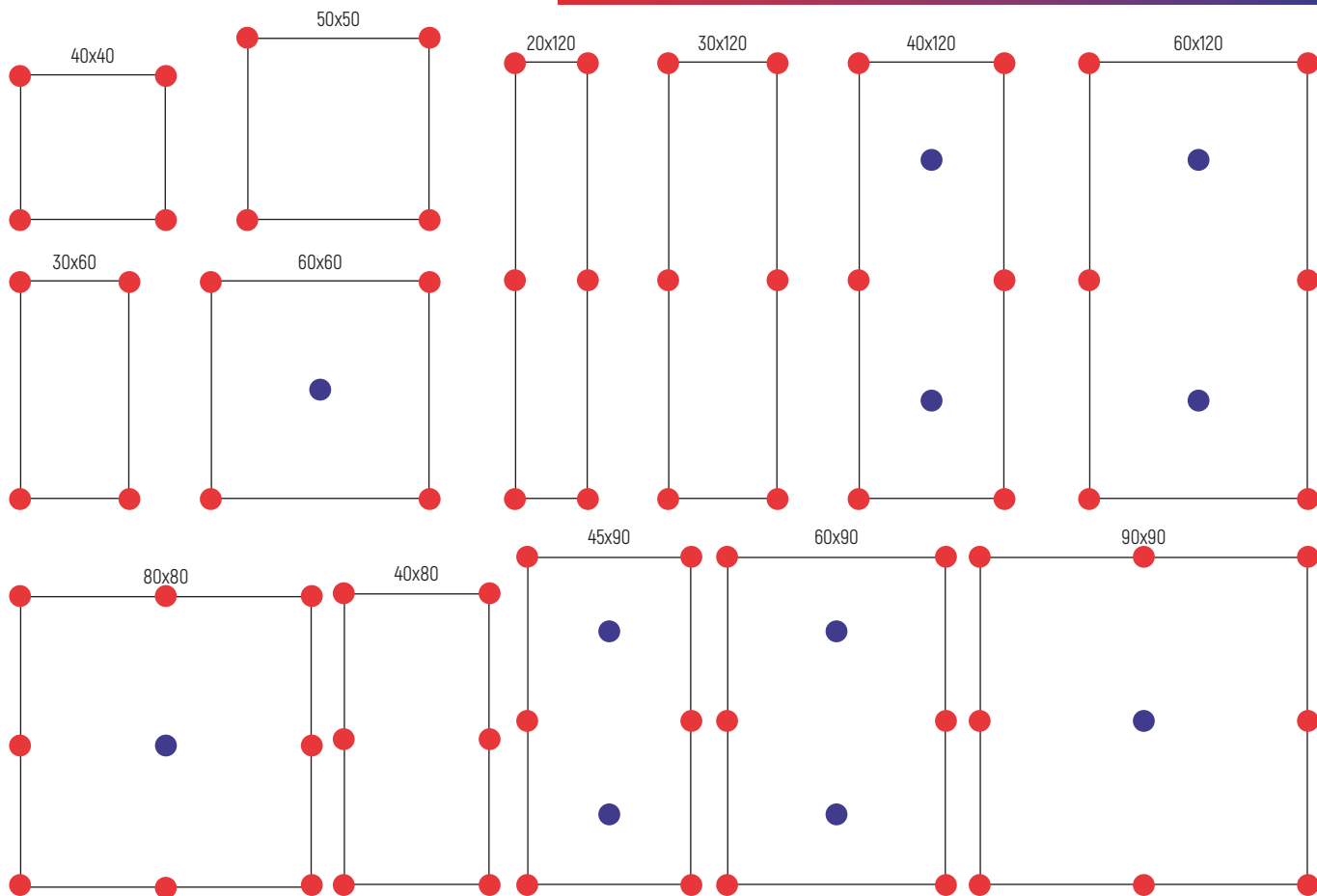

PORTA LOSETAS

Tile holder / Porte-carreaux

Código Code	Descripción Description	Medidas Sizes / Mesures	Uds. caja Units pack / Unités pack	Cajas palet Packs pallet
914508	Porta losetas	33,15 x 33,15cm	12	55
914515	Embellecedor lateral	33,15cm	6 bolsas / 48 uds	-
914522	Embellecedor esquina	-	6 bolsas / 24 uds	-

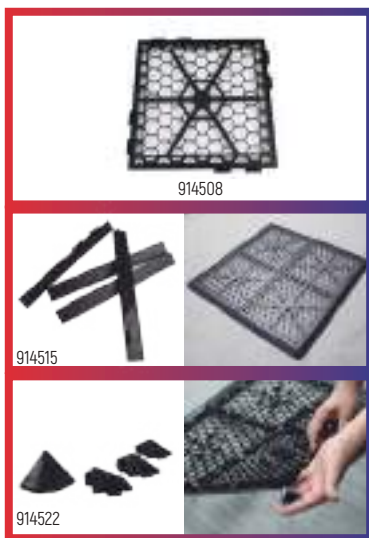

O4. FACHADA Y PAVÉS

Facade and glass block spacer

Façade et entretoise

DISTANCIADOR BLOQUE DE VIDRIO

Glass-block tile spacers / Croix pourr assemblage brique de verre

Código Code	Medidas Sizes/ Mesures	Uds. bolsa Units bag / Unités sachet	Uds. caja Units pack / Unités pack	Cajas palet Packs pallet
915000	10 mm	-	120	55
915017	10 mm	-	300	30
915024	10 mm	30	20 bolsas / 600uds	16

Para bloques estándar 19 x 19 x 8 mm
For standard blocks 19 x 19 x 8 mm
Pour des briques standard 19 x 19 x 8 mm

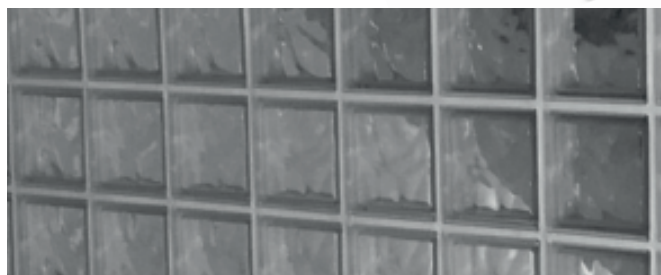

Los separadores en forma de cruz garantizan la correcta separación de los bloques pavés, con un coste bajo y rapidez de colocación.

The glass-block tile spacers on the cross shape guarantees the correct separation of the glass-block with a low cost and speed of placement.

Les séparateurs en forme de croix assurent une séparation correcte de la brique de verre, avec un bas coût et une pose rapide.

GRAPAS DE SEGURIDAD FACHADA (APLACADA)

Safety bracket / Agrafe façades collées

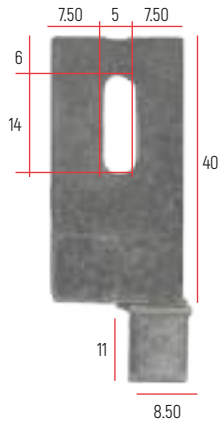

GRAPA SEGURIDAD CENTRAL

Safety initial bracket / Agrafe du bord

Código Code	Medidas Sizes/ Mesures	Uds. caja Units pack / Unités pack	Espesor máx. fijación Maximum Fixing thickness / Epaisseur maximale de fixation	
915031	12 mm	200	Vista View / A vue 10 mm	Oculto Hidden / Cachée 20 mm
915048	18 mm	200	Vista View / A vue 16 mm	Oculto Hidden / Cachée 32 mm

Contiene: 200 tacos 5 x 25 mm + 200 tornillos 3,5 x 40 mm

Contained: 200 block 5 x 25 mm + 200 screw 3,5 x 40 mm / Contient: 200 taco 5 x 25 mm + 200 vis 3,5 x 40 mm

Acero inoxidable AISI-304

Stainless steel AISI-304 / Acier inoxydable AISI-304

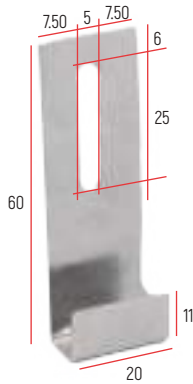

GRAPA SEGURIDAD ARRANQUE FINAL

Safety intermediate bracket / Agrafe intermédiaire

Código Code	Medidas Sizes/ Mesures	Uds. caja Units pack / Unités pack	Espesor máx. fijación Maximum Fixing thickness / Epaisseur maximale de fixation	
915055	12 mm	200	Vista View / A vue 10 mm	Oculto Hidden / Cachée 20 mm
915062	18 mm	200	Vista View / A vue 16 mm	Oculto Hidden / Cachée 32 mm

Contiene: 200 tacos 5 x 25 mm + 200 tornillos 3,5 x 40 mm

Contained: 200 block 5 x 25 mm + 200 screw 3,5 x 40 mm / Contient: 200 taco 5 x 25 mm + 200 vis 3,5 x 40 mm

Acero inoxidable AISI-304

Stainless steel AISI-304 / Acier inoxydable AISI-304





O5. ACCESORIOS DE SEGURIDAD

Safety accessories
Accessoires de sécurité

SETA PROTECTORA

Safety cap / Champignon protecteur



918001

Seta protectora "P" (Varilla de 8 a 20 mm)

Safety cap "P" (rod from 8 a 20 mm)

Capuchon protecteur "P" (barre de 8 a 20 mm)



918018

Seta protectora (Varilla de 8 a 20 mm)

Safety cap (rod from 8 a 20 mm)

Capuchon protecteur (barre de 8 a 20 mm)



918025

Seta protectora (Varilla de 24 a 40 mm)

Safety cap (rod from 24 to 40 mm)

Capuchon protecteur (barre de 24 a 40 mm)

Código Code	Uds. bolsa Units bag / Unités sachet	Uds. palet Units pallet / Unités pallet
918001	250	19.500 - 78 bolsas
918018	250	15.000 - 60 bolsas
918025	150	5.400 - 36 bolsas

Colocación en varilla de acero corrugado saliente. Con su colocación protege al trabajador de las varillas punzantes, en caso de caída o roce. El interior de la pieza está formado por 4 aletas flexibles, para el perfecto anclaje de la varilla.

Placement in protruding corrugated steel rod. With its placement protects the worker from sharp rods, in case of fall or friction. The inside of the piece is formed by 4 flexible fins, for the perfect anchoring of the rod.

Pose sur tige en acier ondulé saillant. Avec son placement protège le travailleur des tiges pointues, en cas de chute ou de frottement. L'intérieur de la pièce est composé de 4 ailettes flexibles, pour l'ancrage parfait de la tige.



BASES SEGURIDAD

Safety bases / Les bases de la sécurité



918070
Base cajetín línea de vida
 Base life line
 Base boîte de ligne de vie



918100
Base horcax (valla de seguridad 60x60)
 Base horca (safety fence 60x60)
 Base horcax (cloture de sécurité 60x60)

Código Code	Medidas Sizes/ Mesures	Uds. bolsa Units bag / Unités sachet	Uds. palet Units pallet / Unités pallet
918070	60 x 40 mm	50	2.500 - 50 bolsas
918100	80 x 80 mm	45 uds. caja	1.350 - 30 cajas



*Tapa incorporada
 Built-in lid / Couvercle intégré



918049
Base guardacuerpos "conix"
 Conix base
 Base garde-corps conix

Código Code	Medidas Sizes/ Mesures	Uds. bolsa Units bag / Unités sachet	Uds. palet Units pallet / Unités pallet
918049	40 mm	150	3.600 - 24 bolsas





06. ACCESORIOS PARA ENCOFRADO

Formwork accessories

Accessoires pour coffrage

TUBOS Y CONOS

Tube and cone / Tubes et cônes

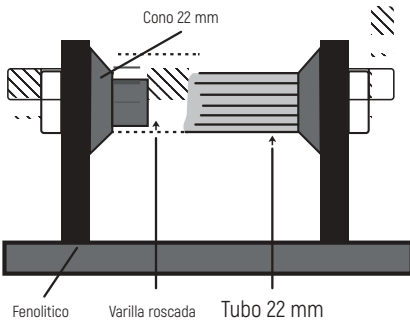

Código Code	Medidas Sizes/ Mesures	Uds. atado Units / Unités	Paquetes palet Pallet packages / Paquets de palette	Uds. bolsa Units bag / Unités sachet	Bolsas Palet Bags pallet / Sacs pallet
916007	Ø 22-26 x 2 mts	25	60	-	-
916014	Ø 26-30 x 2 mts	20	60	-	-
916090	22 mm	-	-	500	104 bolsas / 52.000 uds
916243	26 mm	-	-	1.000	52 bolsas / 52.000 uds
916076	22 mm	-	-	500	102 bolsas / 51.000 uds

TAPONES

Plugs / Bouchons



916113

Tapón estriado para encofrado Ø16
Striated plug for formwork Ø16
Bouchon estrié pour coffrage Ø16



916120

Tapón liso para encofrado Ø18
Flat plug for formwork Ø18
Bouchon lisse pour coffrage Ø18



916205

Tapón liso para encofrado Ø22
Flat plug for formwork Ø22
Bouchon lisse pour coffrage Ø22



916144

Tapón liso para encofrado Ø24
Flat plug for formwork Ø24
Bouchon lisse pour coffrage Ø24



916151

Tapón liso para encofrado Ø26
Flat plug for formwork Ø26
Bouchon lisse pour coffrage Ø26

Código Code	Medidas Sizes/ Mesures	Uds. bolsa Units bag / Unités sachet	Uds. caja Units pack / Unités pack	Uds. Palet Units pallet / Unités pallet
916113	16 mm*	1.000	30 bolsas / 30.000	10 cajas / 300.000
916120	18 mm	1.000	18 bolsas / 18.000	20 cajas / 360.000
916205	22 mm	500	7 bolsas / 3.500	30 cajas / 105.000
916144	24 mm	500	9 bolsas / 4.500	20 cajas / 90.000
916151	26 mm	500	9 bolsas / 4.500	20 cajas / 90.000

TUBO RÁPIDO

Fast tube / Tuyau rapide



Cod. 916083



Cod. 916021

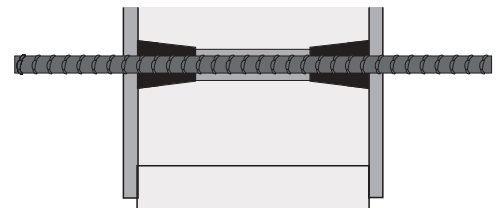

916083

Tapón estriado estanco y muro visto Ø22
Plug, waterproof raw wall Ø22
Bouchon strié étanche et mur apparent Ø22



916021

Tubo rápido encofrado - pasamuro Ø22
Fast formwork tube Ø22
Tuyau de passage rapide de coffrage Ø22



916038

Tubo rápido encofrado - pasamuro Ø22
Fast formwork tube Ø22
Tuyau de passage rapide de coffrage Ø22



916045

Tubo rápido encofrado - pasamuro Ø22
Fast formwork tube Ø22
Tuyau de passage rapide de coffrage Ø22

Código Code	Medidas Sizes/ Mesures	Uds. bolsa Units bag / Unités sachet	Uds. caja Units pack / Unités pack	Uds. Palet Units pallet / Unités pallet
916083	22 mm	500	6 bolsas / 3.000	42 cajas / 126.000
916021	200 mm	-	200	28 cajas / 5.600
916038	250 mm	-	150	28 cajas / 4.200
916045	300 mm	-	100	30 cajas / 3.000

***Para otras medidas, consultar.**
For other measurements, consult.
Pour d'autres mesures, consulter.

BERENJENO Y JUNTA DILATACIÓN

Chamfer strip and dilatation joint / Liteau triangulaire et joint de dilatation

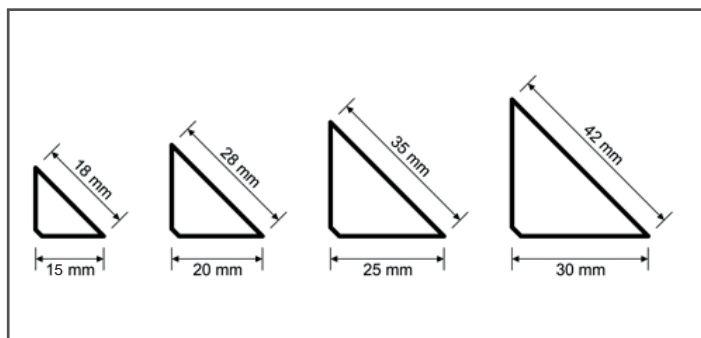
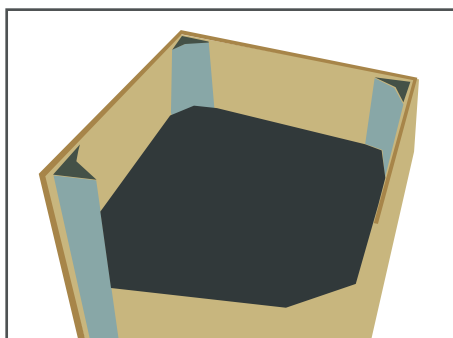

916212
Berenjeno PVC 15mm
Chamfer strip 15mm
Liteau triangulaire 15mm



916168
Berenjeno PVC 20mm
Chamfer strip 20mm
Liteau triangulaire 20mm



916175
Berenjeno PVC 25mm
Chamfer strip 25mm
Liteau triangulaire 25mm



916182
Berenjeno PVC 30mm
Chamfer strip 30mm
Liteau triangulaire 30mm



Código Code	Medidas Sizes/ Mesures	Uds. caja Units pack / Unités pack	Cajas palet Boxes pallet / Boîtes pallet
916212	15 mm x 2,50 mts	100	20
916168	20 mm x 2,50 mts	50	20
916175	25 mm x 2,50 mts	50	20
916182	30 mm x 2,50 mts	50	20

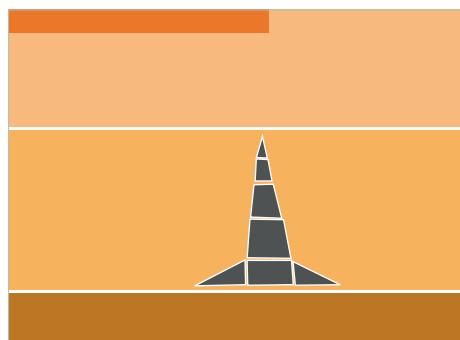

916229
Junta de dilatación 40 mm
Dilatation joint 40 mm
Joint de dilatation 40 mm



916236
Junta de dilatación 80 mm
Dilatation joint 80 mm
Joint de dilatation 80 mm

* Para otros colores y medidas consultar a fábrica.
Check with the company for another sizes and colours.
Pour d'autres couleurs et tailles, consulter l'usine.

Código Code	Medidas Sizes/ Mesures	Uds. caja Units pack / Unités pack	Cajas palet Boxes pallet / Boîtes pallet
916229	40 mm x 2,50 mts	30	30
916236	80 mm x 2,50 mts	20	15

SEPARADORES SIERRA

Saw plastic spacer / Séparateur scie



* Longitud: 2mts x tira
Length: 2mts x strip
Longueur : 2mts x bande



917417
Separador 25 mm
Spacer 25 mm
Séparateur 25 mm



917424
Separador 30 mm
Spacer 30 mm
Séparateur 30 mm

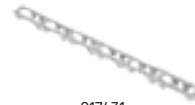

917431
Separador 40 mm
Spacer 40 mm
Séparateur 40 mm



917448
Separador 50 mm
Spacer 50 mm
Séparateur 50 mm

Código Code	Medidas Sizes/ Mesures	Uds. atado Units tied / Unités attaché	Atado por palet Tied per pallet / Attaché par pallet
917417	25 mm x 2 mts	50 Tiras / Strips / Bandes (100 mts)	49 Atados / Tied / Attaché (4.900 mts)
917424	30 mm x 2 mts	50 Tiras / Strips / Bandes (100 mts)	42 Atados / Tied / Attaché (4.200 mts)
917431	40 mm x 2 mts	24 Tiras / Strips / Bandes (60 mts)	76 Atados / Tied / Attaché (2.400 mts)
917448	50 mm x 2 mts	30 Tiras / Strips / Bandes (60 mts)	28 Atados / Tied / Attaché (1.680 mts)

SEPARADOR DE PARRILLA 105 x 250 mm

Rectangular plastic spacer 105 x 250mm / Séparateur de grillage 105 x 250mm

Terminaciones inapreciables
Imperceptible finishes
Fins inestimables



Patas finas
Thin legs
Pâtes fines

Código Code	Medidas Sizes/ Mesures	Uds. caja Units pack / Unités pack	Cajas palet Boxes pallet / Boîtes pallet
917042	20 mm	268	20
917059	25 mm	228	20
917066	30 mm	200	20
917073	35 mm	176	20
917080	40 mm	152	20
917097	50 mm	120	20

SEPARADOR CONDOR

Condor spacer / Séparateur condor



Reforzado
Reinforced
Renforcé

Código Code	Medidas Sizes/ Mesures	Uds. bolsa Units bag / Unités sachet	Uds. palet Units pallet / Unités pallet
917004	20 mm	1.000	90 bolsas / 90.000
917011	30 mm	500	96 bolsas / 48.000
917028	40 mm	500	60 bolsas / 30.000
917035	50 mm	500	36 bolsas / 18.000

SEPARADOR TIMÓN

Rudder spacer / Separateur gouvernail



Código Code	Medidas Sizes/ Mesures	Ø Varilla Ø Dipstick / Ø Tige	Uds. bolsa Units bag / Unités sachet	Uds. palet Units pallet / Unités pallet
917103	20 mm	6 - 12	1.000	48 bolsas / 48.000
917110	25 mm	6 - 12	1.000	44 bolsas / 44.000
917127	30 mm	6 - 14	500	52 bolsas / 26.000
917134	35 mm	6 - 14	500	28 bolsas / 14.000
917141	40 mm	12 - 20	200	60 bolsas / 12.000
917158	50 mm	12 - 20	200	44 bolsas / 8.800
917172	60 mm	12 - 20	200	24 bolsas / 4.800
917455	70 mm	12 - 20	150	21 bolsas / 3.150
917189	70 mm (reforzado)	12 - 20	150	21 bolsas / 3.150

SEPARADORES DE HORMIGÓN

Concrete spacer / Séparateur de béton



917226

Separador cubito 20 mm
Concrete cube spacer 20 mm
Cale béton bloc 20 mm



917233

Separador cubito 25 mm
Concrete cube spacer 25 mm
Cale béton bloc 25 mm



917240

Separador cubito 30 mm
Concrete cube spacer 30 mm
Cale béton bloc 30 mm



917257

Separador cubito 35 mm
Concrete cube spacer 35 mm
Cale béton bloc 35 mm



917264

Separador cubito 40 mm
Concrete cube spacer 40 mm
Cale béton bloc 40 mm



917271

Separador cubito 50 mm
Concrete cube spacer 50 mm
Cale béton bloc 50 mm



917288

Separador cubito 60 mm
Concrete cube spacer 60 mm
Cale béton bloc 60 mm



917295

Separador cubito 70 mm
Concrete cube spacer 70 mm
Cale béton bloc 70 mm



Código Code	Medidas Sizes/ Mesures	Uds. bolsa Units bag / Unités sachet	Uds. palet Units pallet / Unités pallet
917226	20 mm	700	50 bolsas / 35.000 uds. palet
917233	25 mm	400	50 bolsas / 20.000 uds. palet
917240	30 mm	300	50 bolsas / 15.000 uds. palet
917257	35 mm	250	40 bolsas / 10.000 uds. palet
917264	40 mm	200	40 bolsas / 8.000 uds. palet
917271	50 mm	150	45 bolsas / 6.750 uds. palet
917288	60 mm	125	40 bolsas / 5.000 uds. palet
917295	70 mm	100	40 bolsas / 4.000 uds. palet



* Pedido mínimo palet completo
Minimum order full pallet
Commande minimale d'une palette complète



917349

Taco con alambre
Concrete spacer with wire
Taco avec câble



917356

Taco con alambre
Concrete spacer with wire
Taco avec câble



917363

Taco con alambre
Concrete spacer with wire
Taco avec câble



917370

Taco con alambre
Concrete spacer with wire
Taco avec câble



917387

Taco con alambre
Concrete spacer with wire
Taco avec câble



917394

Taco con alambre
Concrete spacer with wire
Taco avec câble



Código Code	Medidas Sizes/ Mesures	Uds. bolsa Units bag / Unités sachet	Uds. palet Units pallet / Unités pallet
917349	20 mm	500	40 bolsas / 20.000 uds. palet
917356	25 mm	400	50 bolsas / 20.000 uds. palet
917363	30 mm	300	45 bolsas / 13.500 uds. palet
917370	40 mm	250	40 bolsas / 10.000 uds. palet
917387	50 mm	200	40 bolsas / 8.000 uds. palet
917394	60 mm	125	40 bolsas / 5.000 uds. palet

* Pedido mínimo palet completo
Minimum order full pallet
Commande minimale d'une palette complète



917202

Separador trivalente
Concrete trivalent spacer
Cale béton trivalente



917196

Separador trivalente
Concrete trivalent spacer
Cale béton trivalente



917400

Separador trivalente con alambre
Concrete trivalent spacer with wire
Cale béton trivalente avec câble



917219

Separador trivalente
Concrete trivalent spacer
Cale béton trivalente



Código Code	Medidas Sizes/ Mesures	Uds. bolsa Units bag / Unités sachet	Uds. palet Units pallet / Unités pallet
917202	20 x 25 x 30 mm	700	40 bolsas / 28.000 uds. palet
917196	35 x 40 x 50 mm	200	50 bolsas / 10.000 uds. palet
917400	35 x 40 x 50 mm	200	50 bolsas / 10.000 uds. palet
917219	45 x 55 x 60 mm	125	40 bolsas / 5.000 uds. palet

* Pedido mínimo palet completo
Minimum order full pallet
Commande minimale d'une palette complète



917332

Redondo hormigón
Concrete circular spacer
Cale béton circulaire



917318

Redondo hormigón
Concrete circular spacer
Cale béton circulaire



917325

Redondo hormigón
Concrete circular spacer
Cale béton circulaire



917301

Separador reticular
Reticulate spacer
Cale béton réticulé



Código Code	Medidas Sizes/ Mesures	Uds. bolsa Units bag / Unités sachet	Uds. palet Units pallet / Unités pallet
917332	35 mm	100	40 bolsas / 4.000 uds. palet
917318	70 mm	-	475
917325	75 mm	-	240
917301	120 mm	100	60 bolsas / 6.000 uds. palet

* Pedido mínimo palet completo
Minimum order full pallet
Commande minimale d'une palette complète



CAPAZOS

Flexitub / Seau de chantier



919107
Capazo 14
Flexitub 14
Baquet 14



919114
Capazo 26
Flexitub 26
Baquet 26



919145
Capazo 30
Flexitub 30
Baquet 30



919152
Capazo 42
Flexitub 42
Baquet 42



919121
Capazo 65
Flexitub 65
Baquet 65



919169
Cubo Obra 11
Bucket 11
Seau 11



919138
Cubo 26
Bucket 26
Seau 26

L x A x H

Código Code	Medidas Sizes/ Mesures	Capacidad Capacity / Capacité	Uds. atado Units tied / Unités attaché	Atado por palet Tied per pallet / Attaché par palette
919107	410 x 330 x 240 mm	14 L - 3,7US gal	12	64
919114	400 x 350 x 340 mm	26 L - 7US gal	12	80
919145	470 x 430 x 280 mm	30 L - 8US gal	12	48
919152	490 x 430 x 385 mm	42 L - 11US gal	12	50
919121	615 x 560 x 380 mm	65 L - 17US gal	12	60
919169	225 x 320 x 225 mm	11 L - 3US gal	12	50
919138	350 x 350 x 330 mm	26 L - 7US gal	12	80



919169

Engomado y resistente
Rubberised and resistant
Gommé et résistant





WWW.TAYG.COM

Industrias Tayg, S.L.U.
Avda. Real de Madrid Norte, 70 - 46469 Beniparrell - Valencia (Spain)
Tlf. +34 96 121 24 62 | marketing@tayg.com | www.tayg.com