

**LONDON** | **E X**  
**& PARIS** | **T E N**  
**D E D**

**VIVES**



## LONDON & PARIS | E X T E N D E D

Una auténtica maravilla de la naturaleza; el fascinante mármol travertino, ha servido de inspiración para las dos tipologías de producto de la colección. Nacidas de un mismo bloque, sus diferentes cortes las convierten en piezas notablemente distintas que comparten gama cromática y armonizan a la perfección:

**PARIS:** gráfica sacada de lastras cortadas siguiendo el sentido de las vetas, con lo que se consigue un rayado paralelo con todos los detalles y matices de la sedimentación por capas.

**LONDON:** el corte del bloque a contraveta, muestra la exuberancia del material, suavizando y equilibrando los contrastes, con un esquema envolvente que anula la direccionalidad.

En **LONDON & PARIS EXTENDED** podemos encontrar el color Natural existente anteriormente y un nuevo color, el Blanco; en todas y cada una de las piezas porcelánicas de la serie.

**LONDON & PARIS EXTENDED** amplía sus propuestas con cuatro nuevos formatos 30x30, 29.3x29.3, 30x60 y 29.3x59.3 cm en dos acabados CL1 y CL2 - R10. Dos nuevos mosaicos, **ABBEY** (con la gráfica del London) y **CHARONNE** (con la gráfica del Paris) en los dos acabados CL1 y CL2 - R10.

Unas últimas piezas, **XTRA PARIS-R NATURAL** y **XTRA PARIS-R BLANCO** en acabado R11 de 20 mm de espesor, pensadas para zonas de agua y colocación en seco, con toda una extensa gama de piezas especiales para piscinas, completan la oferta de la colección **LONDON & PARIS EXTENDED**.

Con **LONDON & PARIS EXTENDED, VIVES** da un paso más hacia la perfección en la apariencia y la funcionalidad de los materiales cerámicos.

# VIVES

*An authentic wonder of nature; The fascinating travertine marble was the inspiration for the two types of products in the collection. Born from the same block of marble, their different cuts make them remarkably different pieces that share a chromatic range and harmonise perfectly:*

**PARIS:** *with the graphic taken from slabs cut following the direction of the veins, something that produces a parallel stripe with all the details and nuances of layered sedimentation.*

**LONDON:** *with the graphic taken as if cut against the veins showing the exuberance of the material, softening and balancing the contrasts, with a surround design that nullifies directionality.*

*In the **LONDON & PARIS EXTENDED** collection, we can find the previously existing Natural colour together with a new colour, White; in each and every one of the porcelain tiles in the series.*

**LONDON & PARIS EXTENDED** expands its proposals with four new sizes 30x30, 29.3x29.3, 30x60 and 29.3x59.3 cm in two finishes CL1 and CL2 - R10. Two new mosaics, **ABBEY** (with the London graphic) and **CHARONNE** (with the Paris graphic) in the two finishes CL1 and CL2 - R10 are also available.

*And finally the last few pieces, **XTRA PARIS-R NATURAL** and **XTRA PARIS-R BLANCO** in R11 in 20mm thickness designed for wet areas such as pools and exteriors or for dry installations. An extensive range of complimentary special pieces are available for swimming pools to complete the whole range.*

*With **LONDON AND PARIS EXTENDED**, VIVES takes another step towards perfection in the appearance and the functionality of ceramic materials.*

## PARIS

CL1  
R10 CL2  
R11 CL3

BLANCO

NATURAL

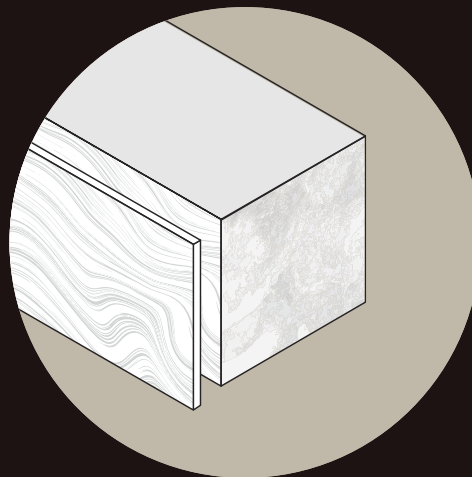
CORTADO A VETA  
CUT IN THE DIRECTION OF THE VEIN

Gráfica sacada de lastras cortadas siguiendo el sentido de las vetas, con lo que se consigue un rayado paralelo con todos los detalles y matices de la sedimentación por capas.

*The graphic was taken from slabs cut in the same direction as the veins, thus achieving a parallel line with all the details and nuances of sedimentation by layers.*

## LONDON



CL1  
R10 CL2  
R12 CL3



BLANCO

NATURAL

## CORTADO A CONTRAVETA

CUT IN THE OPPOSITE DIRECTION OF THE VEIN

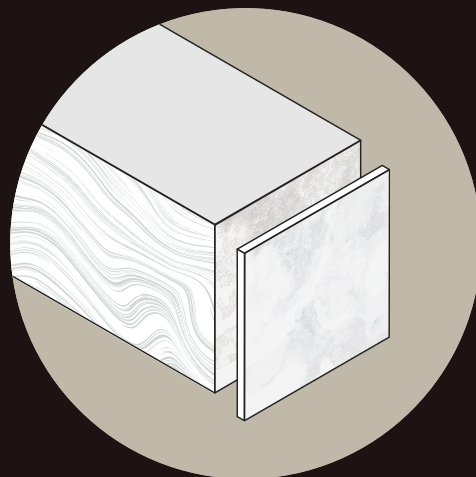

El corte del bloque a contraveta, muestra la exuberancia del material, suavizando y equilibrando los contrastes, con un esquema envolvente que anula la direccionalidad.

*The cut of the slab runs against the grain, shows the exuberance of the material, softening and balancing the contrasts, with an enveloping scheme that nullifies the linear vision.*

## PARIS

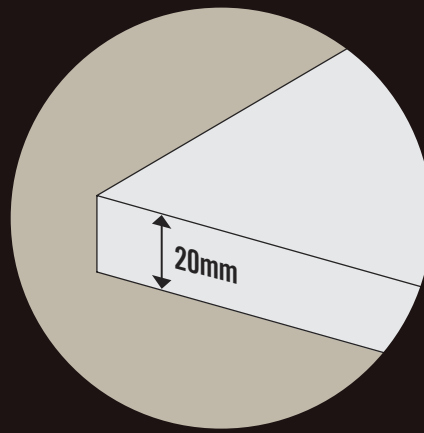
NEW SIZE  
60x120 cm

R11 CL3



BLANCO

NATURAL

Las posibilidades de la cerámica son infinitas, y con **VIVES Xtra** sus aplicaciones se multiplican y adquieren una nueva dimensión. Apostando por un producto innovador y lleno de carácter, en **London&Paris Extended** incorporamos un gres porcelánico de **20 mm de espesor**, producido en el versátil formato 60x120 cm. Su grosor especial asegura una alta resistencia al desgaste y a la rotura, por lo que resulta un producto ideal para exteriores tanto comerciales como residenciales, desde terrazas, hoteles, restaurantes y espacios públicos. Ambientes llenos de carácter y fuerza con el nuevo **VIVES Xtra**.

*The possibilities in ceramics are endless and with **VIVES Xtra**, their potential applications multiply and acquire a new dimension. Betting on an innovative product full of character, At **Vives** we are launching a new **20 mm thick** porcelain tile of excellent qualities, produced in the versatile 60x120 cm format. Its special thickness ensures an excellent resistance to wear and tear, making it an ideal product for both commercial and residential outdoor areas from terraces, hotels, restaurants and public spaces. Spaces full of character and strength with the new **VIVES Xtra**.*





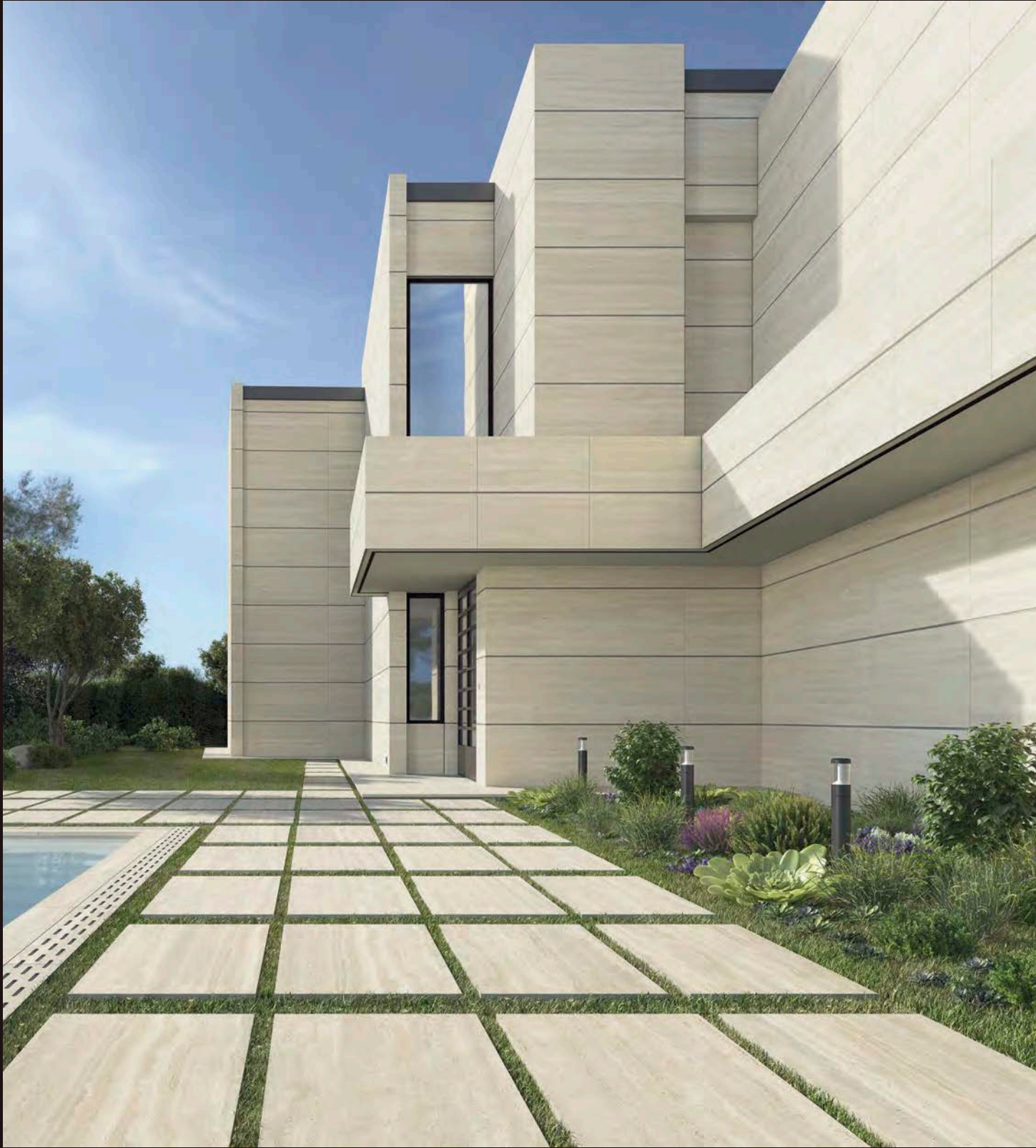

**LA ELEGANCIA DE UN CLÁSICO EN LOS ENTORNOS DE HOY.**

THE ELEGANCE OF A CLASSIC FOR TODAY'S WORLD.



PARIS-R NATURAL · 60X120 CM / SENTIER-R NATURAL / MANHATTAN-R SAND · 32X99 CM / MOSAICO PASSY · 27X31 CM

collection  
VIEW





PARIS-R-BLANCO · 60X120 CM

**RECUPERAR LA ESENCIA ADAPTÁNDOLA AL DÍA A DÍA.**

FINDING THE ESSENCE AND ADAPTING IT TO EVERYDAY LIFE.

**LA SOFISTICACIÓN, LA OSADÍA DEL BUEN GUSTO.**  
SOPHISTICATION, THROUGH THE AUDACITY OF GOOD TASTE.



XTRA PARIS-R NATURAL R11 · 60X120 CM / REJILLA · 19,4X120 CM / TOP · 20X120 CM

COLLECTION  
VIEW



LONDON BLANCO · 30X30 CM / PARIS-R BLANCO · 60X120 CM / PARIS-R BLANCO · 80X180 CM

collection  
VIEW

LONDON-R NATURAL · 120X120 CM / SENTIER-R NATURAL · 32X99 CM



**INTERIORES LLENOS DE CÁLIDA BELLEZA NATURAL.**  
INTERIORS FULL OF WARM NATURAL BEAUTY.





LONDON-R NATURAL · 120X120 CM / PARIS-R NATURAL · 60X120 CM



**EL ATRACTIVO QUE PERDURA EN EL TIEMPO.**

APPEAL THAT LASTS OVER TIME.



PARIS-R BLANCO · 29,3X59,3 CM / LONDON-R BLANCO · 80X80 CM / GRADONE LONDON-R BLANCO · 33X80 CM



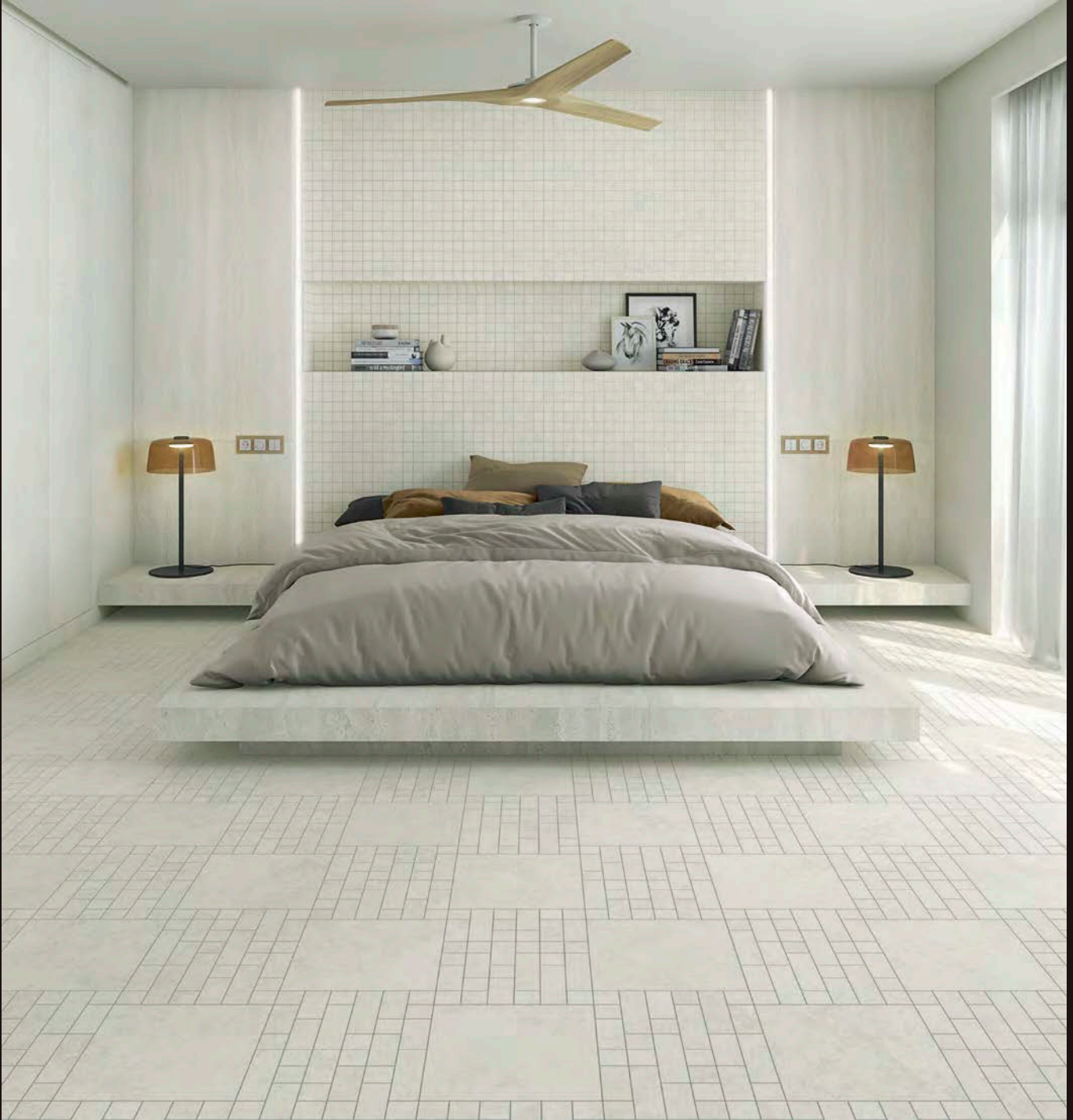

LONDON-R BLANCO · 29,3X29,3 CM / PARIS-R BLANCO · 80X180 CM / MOSAICO ABBEY BLANCO · 29,3X39,1 CM

**UN ESTILO ETERNO QUE RENUEVA LOS SENTIDOS.**

AN ETERNAL STYLE THAT REVITALISES SENSES.

PARIS 

BLANCO

NATURAL



## Porcelánico Porcelain Tile

PARIS



80x180 cm  
31.5x70.9 inches  
Paris-R



60x120 cm  
23.6x47.2 inches  
Paris-R



60x120 cm  
23.6x47.2 inches  
XTRA Paris-R R11  
G.245



30x60 cm  
11.8x23.6 inches  
Paris



29,3x59,3 cm  
11.5x23.3 inches  
Paris-R



Paris-R R10  
G.153



30x30 cm  
11.8x11.8 inches  
Paris



29,3x29,3 cm  
11.5x11.5 inches  
Paris-R



Paris-R R10  
G.152

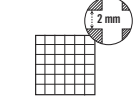

(\*) 30x30 cm aprox  
11.8x11.8 inches approx.  
Mosaico Paris



Mosaico Paris R10  
G.75

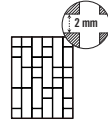

(\*) 29,3x39,1 cm aprox  
(1) 11.5x15.4 inches approx.  
Mosaico Charonne



Mosaico Charonne R10  
G.78

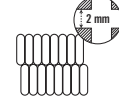

(\*) 27x31 cm aprox  
10.6x12.2 inches approx.  
Mosaico Defense



Mosaico Defense R10  
G.94

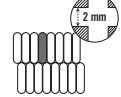

(\*) 27x31 cm aprox  
10.6x12.2 inches approx.  
Mosaico Passy



Mosaico Passy R10  
G.94



(\*) Enmallado  
Meshmounted

(1) Este modelo está compuesto por 3 diseños diferentes para combinar de modo alterno, se sirven en la misma caja.  
This model has 3 different designs that are combined alternately, coming in the same box.



## XTRA PIEZAS ESPECIALES PISCINAS / XTRA SWIMMING POOLS SPECIAL PIECES



19,4x19,4 cm.  
7.6x7.6 inches  
Esquina  
G.78

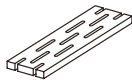

19,4x60 cm.  
7.6x23.6 inches  
Rejilla  
G.81

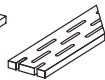

19,4x60 cm.  
7.6x23.6 inches  
Rejilla Esquina Izq.  
G.81

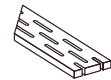

19,4x60 cm.  
7.6x23.6 inches  
Rejilla Esquina Der.  
G.81

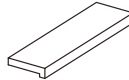

20x60 cm.  
7.9x23.6 inches  
Top  
G.90

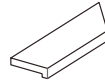

20x60 cm.  
7.9x23.6 inches  
Top Esquina  
Interior Izquierda  
G.91

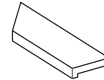

20x60 cm.  
7.9x23.6 inches  
Top Esquina  
Interior Derecha  
G.91

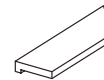

20x60 cm.  
7.9x23.6 inches  
Top Esquina  
Exterior Izquierda  
G.91

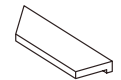

20x60 cm.  
7.9x23.6 inches  
Top Esquina  
Exterior Derecha  
G.91

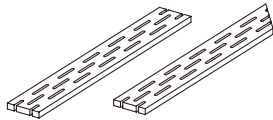

19,4x120 cm.  
7.6x47.2 inches  
Rejilla  
G.91

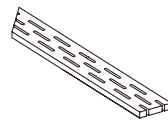

19,4x120 cm.  
7.6x47.2 inches  
Rejilla Esquina Der.  
G.91

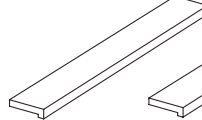

20x120 cm.  
7.9x47.2 inches  
Top  
G.902

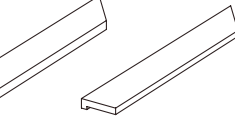

20x120 cm.  
7.9x47.2 inches  
Top Esquina  
Interior Izquierda  
G.902

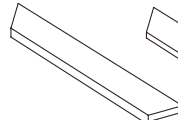

20x120 cm.  
7.9x47.2 inches  
Top Esquina  
Exterior Izquierda  
G.902

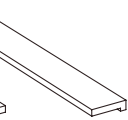

20x120 cm.  
7.9x47.2 inches  
Top Esquina  
Exterior Derecha  
G.902

El peldaño y el gradone pueden servirse con o sin rayado de hendidura. También disponibles en ángulo.  
The Step Tread and gradone can be sold with or without the ribbed notch. Angle is also available.

ANTIDESLIZANTE. Con el fin de dar una mayor seguridad en aquellas áreas transitables, cuyas condiciones de humedad y pendientes son mayores de lo habitual, hemos realizado las pruebas de ensayo según las normas: UNE EN 16165 (UNE 41901:2017 EX, UNE 41902:2017 EX, DIN 51130, DIN 51097, BS 7976-2:2002) y DCOF. Para más información, consultar nuestro departamento técnico.

SLIP RESISTANCE. With the purpose of providing increased safety in areas of pedestrian foot traffic where moisture and/or slopes are greater than normal, we have carried out tests according to the norms: UNE EN 16165 (UNE 41901:2017 EX, UNE 41902:2017 EX, DIN 51130, DIN 51097, BS 7976-2:2002) and DCOF. For more information on this, contact our Technical Department.



CL 3	CL 2
R 11	R 10
CL C	CL B
+ 0.42	+ 0.42
+ 36	+ 36

XTRA Paris R11 Paris R10

PARIS	FORMATOS	SIZE	CAJA / BOX			PALET / PALLET				
			PIEZAS / PIECES	M²	ML	KG	CAJA / BOX	M²	ML	KG
	27x31 cm Mosaico	10.6x12.2 inches	10	0.84	-	18.44	30	25.20	-	553.2
	8.2 29,3x29,3 cm	11.5x11.5 inches	11	0.94	-	17.821	64	60.416	-	1140.54
	8.2 30x30 cm	11.8x11.8 inches	11	0.99	-	18.58	64	63.36	-	1188.80
	30x30 cm Mosaico	11.8x11.8 inches	12	1.08	-	19.61	30	32.40	-	588.30
	29,3x39,1 cm Mosaico	11.5x15.4 inches	13	1.495	-	24.23	30	44.85	-	726.87
	8.2 29,3x59,3 cm	11.5x23.3 inches	7	1.22	-	22.80	40	48.60	-	912
	8.2 30x60 cm	11.8x23.6 inches	7	1.26	-	23.60	40	50.40	-	944
	11 60x120 cm	23.6x47.2 inches	2	1.44	-	36.13	24	34.56	-	867
	20 60x120 cm XTRA	23.6x47.2 inches	1	0.72	-	33.70	35	25.20	-	1179.5
	11 80x180 cm	31.5x70.9 inches	1	1.44	-	36.125	38	54.72	-	1400
	Rodapié cortado y biselado Cut and Bevelled skirting tile	6.32 9,4x30 cm	3.7x11.8 inches	40	-	12	21.15	64	-	768
6.912 9,4x29,3 cm		3.7x11.5 inches	40	-	11,72	20,65	64	-	750,08	1321,60
6.916 9,4x60 cm (Rectificado)		3.7x23.6 inches	15	-	9	18,98	56	-	504	1062,88
6.54 9,4x80 cm		3.7x31.5 inches	15	-	12	21,60	54	-	648	1166,40
Peldaño / Step Tread	6.77 29,3x29,3 cm	11.5x11.5 inches	11	-	3.22	17.821	-	-	-	-
	6.56 30x30 cm	11.8x11.8 inches	11	-	3.30	18.58	-	-	-	-
	6.907 29,3x59,3 cm	11.5x23.3 inches	7	-	4.15	22.80	-	-	-	-
	6.94 30x60 cm	11.8x23.6 inches	7	-	4.20	23.60	-	-	-	-
	6.92 33x120 cm	13x47.2 inches	1	-	1.20	10	-	-	-	-
	6.91 33x180 cm	13x70.9 inches	1	-	1.80	15	-	-	-	-
	6.81 29,3x29,3 cm	11.5x11.5 inches	3	-	0.879	6.05	-	-	-	-
Gradone	6.80 30x30 cm	11.8x11.8 inches	3	-	0.90	6.27	-	-	-	-
	6.90 29,3x59,3 cm	11.5x23.3 inches	3	-	1.78	12.99	-	-	-	-
	6.910 30x60 cm	11.8x23.6 inches	3	-	1.8	12.54	-	-	-	-
	6.902 33x120 cm	13x47.2 inches	1	-	1.20	13	-	-	-	-
	6.95 33x180 cm	13x70.9 inches	1	-	1.20	19	-	-	-	-

BLANCO

LONDON 

NATURAL



Porcelánico  
Porcelain Tile

LONDON

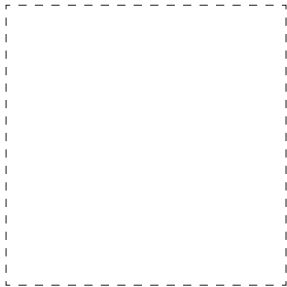

120x120 cm.  
47.2x47.2 inches  
London-R

London-R R10  
London-R R12  
G.171



80x80 cm.  
31.5x31.5 inches  
London-R

London-R R10  
London-R R12  
G.161

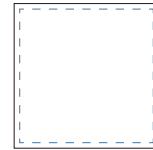

60x60 cm.  
23.6x23.6 inches  
London

London R10  
London R12  
G.192  
59.3x59.3 cm  
23.3x23.3 inches  
London-R  
London-R R10  
London-R R12  
G.158



30x60 cm  
11.8x23.6 inches  
London

London R10  
G.286  
29.3x59.3 cm  
11.5x23.3 inches  
London-R

London-R R10  
G.153



30x30 cm  
11.8x11.8 inches  
London

London R10  
G.301  
29.3x29.3 cm  
11.5x11.5 inches  
London-R  
London-R R10  
G.152

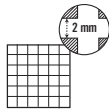

(\*) 30x30 cm aprox  
11.8x11.8 inches approx.  
Mosaico London  
Mosaico London R10  
G.75

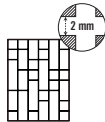

(\*) 29.3x39.1 cm aprox  
(1) 11.5x15.4 inches approx.  
Mosaico Abbey  
Mosaico Abbey R10  
G.78

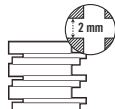

(\*) 30x30 cm aprox  
11.8x11.8 inches approx.  
Mosaico Hackney  
Mosaico Hackney R10  
G.61

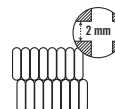

(\*) 27x31 cm aprox  
10.6x12.2 inches approx.  
Mosaico Mayfair  
Mosaico Mayfair R10  
G.94

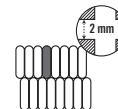

(\*) 27x31 cm aprox  
10.6x12.2 inches approx.  
Mosaico Barbican  
Mosaico Barbican R10  
G.94

(1) Este modelo está compuesto por 3 diseños diferentes para combinar de modo alterno, se sirven en la misma caja.  
This model has 3 different designs that are combined alternately, coming in the same box.

El peldaño y el gradone pueden servirse con o sin rayado de hendidura. También disponibles en ángulo.  
The Step Tread and gradone can be sold with or without the ribbed notch. Angle is also available.

ANTIDESLIZANTE. Con el fin de dar una mayor seguridad en aquellas áreas transitables, cuyas condiciones de humedad y pendientes son mayores de lo habitual, hemos realizado las pruebas de ensayo según las normas: UNE EN 16165 (UNE 41901:2017 EX, UNE 41902:2017 EX, DIN 51130, DIN 51097, BS 7976-2:2002) y DCOF. Para más información, consultar nuestro departamento técnico.

SLIP RESISTANCE. With the purpose of providing increased safety in areas of pedestrian foot traffic where moisture and/or slopes are greater than normal, we have carried out tests according to the norms: UNE EN 16165 (UNE 41901:2017 EX, UNE 41902:2017 EX, DIN 51130, DIN 51097, BS 7976-2:2002) and DCOF. For more information on this, contact our Technical Department.

(\*) Enmallado Meshmounted  
CL 3 R 12 CL C + 0.42 + 36  
CL 2 R 10 CL B + 0.42 + 36  
London R12 London R10

LONDON		CAJA / BOX				PALET / PALLET					
		FORMATOS	SIZE	PIEZAS / PIECES	M <sup>2</sup>	ML	KG	CAJA / BOX	M <sup>2</sup>	ML	KG
		27x31 cm Mosaico	10.6x12.2 inches	10	0.84	-	17.09	30	25.20	-	512.70
	8,2	29.3x29.3 cm	11.5x11.5 inches	11	0.94	-	17.821	64	60.416	-	1140.54
	8,2	30x30 cm	11.8x11.8 inches	11	0.99	-	18.58	64	63.36	-	1188.80
		30x30 cm Mosaico	11.8x11.8 inches	12	1.08	-	19.61	30	32.40	-	588.30
		29.3x39.1 cm Mosaico	11.5x15.4 inches	13	1.495	-	24.23	30	44.85	-	726.87
	8,2	29.3x59.3 cm	11.5x23.3 inches	7	1.22	-	22.80	40	48.60	-	912
	8,2	30x60 cm	11.8x23.6 inches	7	1.26	-	23.60	40	50.40	-	944
	10	59.3x59.3 cm	23.3x23.3 inches	3	1.055	-	24.30	40	42.20	-	972
	10	60x60 cm	23.6x23.6 inches	3	1.08	-	24.95	40	43.20	-	997.80
	10	80x80 cm	31.5x31.5 inches	2	1.28	-	29.40	42	53.76	-	1234.84
	11	120x120 cm	47.2x47.2 inches	1	1.44	-	36.125	38	54.72	-	1400
	6.32	9.4x30 cm	3.7x11.8 inches	40	-	12	21.15	64	-	768	1353.60
	6.912	9.4x29.3 cm	3.7x11.5 inches	40	-	11.72	20.65	64	-	750.08	1321.60
	6.916	9.4x59.3 cm	3.7x23.3 inches	17	-	10.08	21.20	56	-	564.40	1187.20
	6.915	9.4x60 cm.	3.7x23.6 inches	17	-	10.20	21.47	56	-	571.20	1202.32
	6.54	9.4x80 cm.	3.7x31.5 inches	15	-	12	21.60	54	-	648	1166.40
	6.67	9.4x120 cm	3.7x47.2 inches	10	-	12	28.2	36	-	432	1015.2
	6.77	29.3x29.3 cm	11.5x11.5 inches	11	-	3.22	17.821	-	-	-	-
	6.56	30x30 cm	11.8x11.8 inches	11	-	3.30	18.58	-	-	-	-
	6.907	29.3x59.3 cm	11.5x23.3 inches	7	-	4.15	22.80	-	-	-	-
	6.94	30x60 cm	11.8x23.6 inches	7	-	4.20	23.60	-	-	-	-
	6.917	33x59.3 cm	13x23.3 inches	1	-	0.59	5.27	-	-	-	-
	6.76	33x60 cm	13x23.6 inches	1	-	0.60	5.30	-	-	-	-
	6.83	33x80 cm	13x31.5 inches	1	-	0.80	6.5	-	-	-	-
	6.92	33x120 cm	13x47.2 inches	1	-	1.20	10	-	-	-	-
	6.81	29.3x29.3 cm	11.5x11.5 inches	3	-	0.879	6.05	-	-	-	-
	6.80	30x30 cm	11.8x11.8 inches	3	-	0.90	6.27	-	-	-	-
	6.90	29.3x59.3 cm	11.5x23.3 inches	3	-	1.78	12.09	-	-	-	-
	6.910	30x60 cm	11.8x23.6 inches	3	-	1.8	12.54	-	-	-	-
	6.910	33x59.3 cm.	13x23.3 inches	1	-	0.59	6	-	-	-	-
	6.89	33x60 cm.	13x23.6 inches	1	-	0.60	6.10	-	-	-	-
	6.85	33x80 cm.	13x31.5 inches	1	-	0.80	7	-	-	-	-
	6.902	33x120 cm.	13x47.2 inches	1	-	1.20	13	-	-	-	-





VIVES

Vives Azulejos y Gres, S.A. se reserva el derecho de anular y modificar, total o parcialmente, cualquiera de los modelos, colores, formatos, referencias y especificaciones técnicas contenidas en este catálogo.

Prohibida la reproducción total o parcial de este catálogo sin autorización expresa de Vives Azulejos y Gres, S.A.

Los colores de las piezas de este catálogo son orientativos.

Fecha de publicación: SEPTIEMBRE 2024

Vives Azulejos y Gres, S.A. reserves the right to delete and amend, either totally or partially, any of the styles, colours, shapes, sizes, references and other technical specifications contained in this catalogue.

The total or partial reproduction of this catalogue without prior written authorization from Vives Azulejos y Gres, S.A. is strictly prohibited.

The colours shown in this catalogue are for guidance only.

Publishing date: SEPTEMBER 2024

VIVES



bimVIVES



**VIVES AZULEJOS Y GRES S.A.**

Ctra Castellón Km 23 Apdo correos 14 · 12110 Alcora ( Castellón - Spain ) · Tel : (+34) 964 360 725  
E-mail: nacional@vivesceramica.com · E-mail: export@vivesceramica.com

DESIGNED & DEVELOPED BY VIVES AZULEJOS Y GRES S.A.