

Index/

Gennaio 2025

9CENTO	/004	METAL STICKS	/075
9cento Alba Oro 9cento Aurora Beige 9cento Metamorfosi 9cento Ombra Moca 9cento Raggio Verde 9cento Riflesso Bianco		Metal Stick Arancione Metal Stick Gold Metal Stick Moka Metal Stick Nero Metal Stick Ottone Metal Stick Silver Metal Stick Verde	
ARKE'	/007	MIDLAKE	/076
Arke Anthracite Arke Beige Arke Clay Arke Grey Arke Ivory		Midlake Ardesia Midlake Porfido Midlake Quartzbeige Midlake Quartzgrey	
BRYSTONE	/012	MOOV	/077
Brystone Avana Brystone Gold Brystone Grey Brystone Ivory Brystone White		Moov Anthracite Moov Beige Moov Grey Moov Ivory Moov Moka	
CHORUS	/018	NOORD	/086
Chorus Beige Chorus Grey Chorus Silver Chorus White		Noord Anthracite Noord Gold Noord Grey Noord Ivory Noord Silver Noord Taupe Noord White	
DISCOVERY	/022	OMNIA	/092
Discovery Ardesia Grey Discovery Ardesia Silver Discovery Cotto Beige Discovery Cotto Red Discovery Leccese Ivory Discovery Leccese Taupe		Omnia Ceppo Grey Omnia Devix Greige Omnia Emperador White Omnia Rapolano Beige Omnia Romano Sand Omnia Tivoli Ivory Omnia Venezia Ivory	
DISTRICT	/023	ONICE	/096
District Greige District Grey District Ivory District Silver District White		Onice Honey Onice Multicolor Onice Pearl	
DOLMIX	/028	PERCORSI EXTRA	/099
Dolmix Dark Dolmix Grey Dolmix Light		Percorsi Extra Pietra Di Barge Percorsi Extra Pietra Di Combe Percorsi Extra Pietra Di Vals Percorsi Extra Pietra di Faedis Percorsi Extra Sight Anthr.	
ELEMENTS DESIGN	/031	PERCORSI FRAME	/103
Elements Design Beige Elements Design Black Elements Design Grey Elements Design Ivory Elements Design Silver Elements Design Taupe Elements Design White		Percorsi Frame Gneiss Grey Percorsi Frame Imperiale Walnut Percorsi Frame Plima Silver Percorsi Frame Travertino Beige	
ELEMENTS LUX	/039	PERCORSI SMART	/107
Elements Lux Calacatta Elements Lux Calacatta Gold Elements Lux Calacatta Statuarietto Elements Lux Emperador Elements Lux Lincoln Elements Lux Persian Grey Elements Lux Port Laurent Elements Lux Silver Grey		Percorsi Smart Pietra di Bagnolo Percorsi Smart Pietra di Bressa Percorsi Smart Pietra di Lavis	
EVOKE	/049	PLATE	/111
Evoke Beige Evoke Brown Evoke Sand		Plate Anthracite Plate Brass Plate Copper Plate Luxury Gold Plate Luxury Platinum Plate Oxyde Plate Precious Dark Plate Silver Plate Tin Plate Titanium Plate Zinc	
GEO	/050	SOUL	/115
Geo Beige Geo Grey Geo Ivory Geo Shape Geo Silver Geo Walnut Geo White		Soul Grey Soul Walnut	
HERITAGE	/056	STREET	/116
Heritage Beige Heritage Geometric Coral Heritage Geometric Mist Heritage Geometric Ocean Heritage Geometric Sand Heritage Grey Heritage Ivory Heritage Pearl		Street Londra Beige Street Londra Grey Street Milano Ivory Street Milano Silver	
IKON	/060	TREVI	/117
Ikon Silver Ikon White		Trevi Ivory Trevi Pearl Trevi Walnut	
INTERNO4	/064	UBIK	/120
Interno4 Breccia Tortona Interno4 Calacatta San Babila		Ubik Anthracite Ubik Greige Ubik Grey Ubik Ivory Ubik Walnut	
JOURNEY	/068	UNICA	/125
Journey Almond Journey Blossom Journey Bone Journey Caramel Journey Honey Journey Leaves Journey Springtime Journey Watercolor		Unica Almond Unica Beige Unica Brown Unica Grey Unica Honey Unica Ivory	
LAVICA	/070	VERSILIA	/127
Lavica Anthracite Lavica Black Lavica Etna Anthracite Lavica Grey Lavica Stromboli Grey Lavica Vesuvio Grey Lavica Vulcano Anthracite		Versilia Bardiglio Silver Versilia Fiorito Ivory Versilia Nuvolato Grey	
LIMES	/073	DUNSTONE (CONTRACT)	/132
Limes Porfido Cold Limes Porfido Warm Limes Quartz Multicolor Limes Quartz White		Dunstone Beige Dunstone Grey Dunstone Ivory	
LINEO	/074	EXTREME (CONTRACT)	/134
Lineo Brown Lineo Honey Lineo Sand Lineo Walnut Lineo White		Extreme Anthracite Extreme Beige Extreme Grey	
		LONDALE (CONTRACT)	/135
		Londale Beige Londale Grey Londale Silver	
		POINT (CONTRACT)	/137
		POINT BEIGE MULTICOLOR POINT GREY MULTICOLOR Point Beige Multicolor Point Grey Multicolor Point Sand Point Silver	

Index/

Gennaio 2025

SWISSTONE (CONTRACT)	/138
Swisstone Anthracite Swisstone Grey	
SYNTECH (CONTRACT)	/139
Syntech Beige Syntech Silver Syntech Taupe Syntech White	
URBAN (CONTRACT)	/141
Urban Anthracite Urban Grey Urban Ivory	
OUTDOOR 20MM	/143
OUTDOOR 20MM - PEZZI SPECIALI / TRIMS	/151
OUTDOOR TRIMS E ACCESSORIES	/155

Size	Code	Colour	Euro	U.M.	Pcs / Box	Mq / Box	Kg / Box	Mq / Pallet	Kg / Pallet	Box / Pallet
------	------	--------	------	------	--------------	-------------	-------------	----------------	----------------	-----------------

9CENTO

EFFETTO MARMO - MARBLE EFFECT - EFFET MARBRE - MARMOR EFFEKT

120x278 (48"x110") (119,5x278)* - 6 mm - Rettificato

◆ Lappato

F9A4	9CENTO ALBA ORO	168,00	MQ	1	3,32	49,56	59,80	990,08	18
F9A2	9CENTO AURORA BEIGE	161,70							
F9A1	9CENTO RAGGIO VERDE	168,00							
F9A5	9CENTO RIFLESSO BIANCO	168,00							

Addebito cassa leggera (max7pz) (prezzo netto) / Light crate charge (max7pz) (net price) / Débit de caisse (max7pz) (prix net) / Kasse belasten (max7pz) (Nettopreis) - € 100
 Addebito cassa (prezzo netto) / Crate charge (net price) / Palette supplémentaire (prix net) / Aufpreispalette (Nettopreis) - € 160
 Addebito cavalletto 18pz (prezzo netto) / Extra rack 18pcs (net price) / Chevalet supplémentaire 18pcs (prix net) / Aufpreisgestell 18St (Nettopreis) - € 270
 Addebito cavalletto 42pz (prezzo netto) / Extra rack 42pcs (net price) / Chevalet supplémentaire 42pcs (prix net) / Aufpreisgestell 42St (Nettopreis) - € 270

60x120 (24"x48") - 9 mm - Rettificato

◆ Lappato

F9D5	9CENTO ALBA ORO	113,70	MQ	2	1,44	31,93	50,40	1.138,00	35
F9D2	9CENTO AURORA BEIGE	109,10							
F9D3	9CENTO OMBRA MOCA	109,10							
F9D1	9CENTO RAGGIO VERDE	113,70							
F9D4	9CENTO RIFLESSO BIANCO	113,70							

60x120 (24"x48") Palladiana - 9 mm - Rettificato

◆ Lappato

F9D6	9CENTO METAMORFOSI	115,90	MQ	2	1,44	31,93	50,40	1.138,00	35
------	--------------------	--------	----	---	------	-------	-------	----------	----

35x35 (13.80"x13.80") Mosaico Palm Mix (10x10) - 9 mm - Rettificato

◆ Lappato

F9M6	9CENTO (RIFLESSO B. / OMBRA M. / RAGGIO V.)	37,90	PZ	6	0,54	11,20	25,92	550,60	48
------	---	-------	----	---	------	-------	-------	--------	----

Venduti solo a scatole complete / Only full boxes sold /
 Vendus par boîte complete / Nur volle Karton



9CENTO

Size	Code	Colour	Euro	U.M.	Pcs / Box	Mq / Box	Kg / Box	Mq / Pallet	Kg / Pallet	Box / Pallet
------	------	--------	------	------	--------------	-------------	-------------	----------------	----------------	-----------------

9CENTO

EFFETTO MARMO - MARBLE EFFECT - EFFET MARBRE - MARMOR EFFEKT

30x30 (12"x12") Mosaico T36 (4,8x4,8) - 9 mm - Rettificato

◆ Lappato

M5F9	9CENTO ALBA ORO	20,20	PZ	10	0,90	17,00	27,00	523,00	30
M2F9	9CENTO AURORA BEIGE	20,20							
M3F9	9CENTO OMBRA MOCA	20,20							
M1F9	9CENTO RAGGIO VERDE	20,20							
M4F9	9CENTO RIFLESSO BIANCO	20,20							

Venduti solo a scatole complete / Only full boxes sold /
Vendus par boîte complete / Nur volle Karton

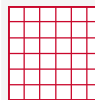

33x120x4 (13"x48") Scalino incollato - 9 mm - Rettificato

◆ Lappato

F9Q5	9CENTO ALBA ORO	268,50	PZ	2	0,79	18,40	19,01	454,60	24
F9Q2	9CENTO AURORA BEIGE	268,50							
F9Q3	9CENTO OMBRA MOCA	268,50							
F9Q1	9CENTO RAGGIO VERDE	268,50							
F9Q4	9CENTO RIFLESSO BIANCO	268,50							

Lavorato su richiesta e venduto solo a scatole complete / Manufactured upon request
and only full boxes sold / Seulement à la demande et vendus par boîte complete / Nur
auf Anfrage und nur volle Karton

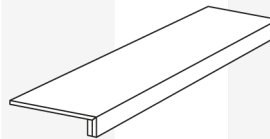

33x120x4 (13"x48") Scalino angolare incollato - 9 mm - Rettificato

◆ Lappato

F9X5	ALBA ORO ANG. DX	295,30	PZ	1	0,40	9,00	9,50	238,60	24
F9Y5	ALBA ORO ANG. SX	295,30							
F9X2	AURORA BEIGE ANG. DX	295,30							
F9Y2	AURORA BEIGE ANG. SX	295,30							
F9X3	OMBRA MOCA ANG. DX	295,30							
F9Y3	OMBRA MOCA ANG. SX	295,30							
F9X1	RAGGIO VERDE ANG. DX	295,30							
F9Y1	RAGGIO VERDE ANG. SX	295,30							
F9X4	RIFLESSO BIANCO ANG. DX	295,30							
F9Y4	RIFLESSO BIANCO ANG. SX	295,30							

Lavorato su richiesta e venduto solo a scatole complete / Manufactured upon request
and only full boxes sold / Seulement à la demande et vendus par boîte complete / Nur
auf Anfrage und nur volle Karton

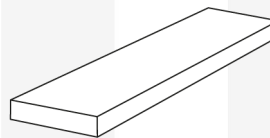

9CENTO

Size	Code	Colour	Euro	U.M.	Pcs / Box	Mq / Box	Kg / Box	Mq / Pallet	Kg / Pallet	Box / Pallet
------	------	--------	------	------	-----------	----------	----------	-------------	-------------	--------------

9CENTO

EFFETTO MARMO - MARBLE EFFECT - EFFET MARBRE - MARMOR EFFEKT

33x60x4 (13"x24") Scalino incollato - 9 mm - Rettificato

◆ Lappato

F9S5	9CENTO ALBA ORO	129,40	PZ	4	0,79	21,70	19,01	533,80	24
F9S2	9CENTO AURORA BEIGE	129,40							
F9S3	9CENTO OMBRA MOCA	129,40							
F9S1	9CENTO RAGGIO VERDE	129,40							
F9S4	9CENTO RIFLESSO BIANCO	129,40							

Lavorato su richiesta e venduto solo a scatole complete / Manufactured upon request and only full boxes sold / Seulement à la demande et vendus par boîte complete / Nur auf Anfrage und nur volle Karton

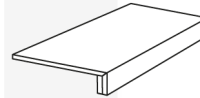

33x33x4 (13"x13") Scalino angolare incollato - 9 mm - Rettificato

◆ Lappato

F9V5	9CENTO ALBA ORO	158,00	PZ	4	0,44	14,48	13,07	447,40	30
F9V2	9CENTO AURORA BEIGE	158,00							
F9V3	9CENTO OMBRA MOCA	158,00							
F9V1	9CENTO RAGGIO VERDE	158,00							
F9V4	9CENTO RIFLESSO BIANCO	158,00							

Lavorato su richiesta e venduto solo a scatole complete / Manufactured upon request and only full boxes sold / Seulement à la demande et vendus par boîte complete / Nur auf Anfrage und nur volle Karton



4,6x120 (1.80"x48") Battiscopa - 9 mm - Rettificato

◆ Lappato

				Mt						
R5F9	9CENTO ALBA ORO	34,20	PZ	6	7,20	7,80	345,60	387,40	48	
R2F9	9CENTO AURORA BEIGE	34,20								
R3F9	9CENTO OMBRA MOCA	34,20								
R1F9	9CENTO RAGGIO VERDE	34,20								
R4F9	9CENTO RIFLESSO BIANCO	34,20								

Venduti solo a scatole complete / Only full boxes sold / Vendus par boîte complete / Nur volle Karton



7,2x60 (2.80"x24") Battiscopa - 9 mm - Rettificato

◆ Lappato

				Mt						
F9R5	9CENTO ALBA ORO	16,30	PZ	10	6,00	10,48	480,00	851,40	80	
F9R2	9CENTO AURORA BEIGE	16,30								
F9R3	9CENTO OMBRA MOCA	16,30								
F9R1	9CENTO RAGGIO VERDE	16,30								
F9R4	9CENTO RIFLESSO BIANCO	16,30								

Venduti solo a scatole complete / Only full boxes sold / Vendus par boîte complete / Nur volle Karton



9CENTO

Size	Code	Colour	Euro	U.M.	Pcs / Box	Mq / Box	Kg / Box	Mq / Pallet	Kg / Pallet	Box / Pallet
------	------	--------	------	------	-----------	----------	----------	-------------	-------------	--------------

ARKE'

EFFETTO PIETRA - STONE EFFECT - EFFET PIERRE - STEIN EFFEKT

120x120 (48"x48") (119,5x119,5)* - 9 mm - Rettificato

Spazzolato R10

I6C1	ARKE ANTHRACITE	91,20	MQ	2	2,86	60,80	57,12	1.251,00	20
I6C4	ARKE BEIGE	94,80							
I6C3	ARKE CLAY	91,20							
I6C2	ARKE GREY	91,20							
I6C5	ARKE IVORY	94,80							

60x120 (24"x48") - 9 mm - Rettificato

Spazzolato R10

I6D1	ARKE ANTHRACITE	77,30	MQ	2	1,44	31,93	50,40	1.138,00	35
I6D4	ARKE BEIGE	80,30							
I6D3	ARKE CLAY	77,30							
I6D2	ARKE GREY	77,30							
I6D5	ARKE IVORY	80,30							

Structured R11

D1I6	ARKE ANTHRACITE	77,30							
D4I6	ARKE BEIGE	80,30							
D3I6	ARKE CLAY	77,30							
D2I6	ARKE GREY	77,30							
D5I6	ARKE IVORY	80,30							

60x60 (24"x24") - 9 mm - Rettificato

Spazzolato R10

I6H1	ARKE ANTHRACITE	56,70	MQ	3	1,08	21,00	43,20	853,00	40
I6H4	ARKE BEIGE	58,20							
I6H3	ARKE CLAY	56,70							
I6H2	ARKE GREY	56,70							
I6H5	ARKE IVORY	58,20							

Structured R11

H1I6	ARKE ANTHRACITE	56,70							
H4I6	ARKE BEIGE	58,20							
H3I6	ARKE CLAY	56,70							
H2I6	ARKE GREY	56,70							
H5I6	ARKE IVORY	58,20							

ARKE'

Size	Code	Colour	Euro	U.M.	Pcs / Box	Mq / Box	Kg / Box	Mq / Pallet	Kg / Pallet	Box / Pallet
------	------	--------	------	------	-----------	----------	----------	-------------	-------------	--------------

ARKE'

EFFETTO PIETRA - STONE EFFECT - EFFET PIERRE - STEIN EFFEKT

30x60 (12"x24") - 9 mm - Rettificato

□ Spazzolato R10

I6I1	ARKE ANTHRACITE	46,90	MQ	7	1,26	25,00	50,40	1.016,00	40
I6I4	ARKE BEIGE	48,40							
I6I3	ARKE CLAY	46,90							
I6I2	ARKE GREY	46,90							
I6I5	ARKE IVORY	48,40							

▲ Structured R11

I1I6	ARKE ANTHRACITE	46,90							
I4I6	ARKE BEIGE	48,40							
I3I6	ARKE CLAY	46,90							
I2I6	ARKE GREY	46,90							
I5I6	ARKE IVORY	48,40							

60x120 (24"x48") - 20 mm - Rettificato

▲ Structured R11

I6W1	ARKE ANTHRACITE	110,20	MQ	1	0,72	33,75	25,20	1.202,25	35
I6W4	ARKE BEIGE	112,30							
I6W3	ARKE CLAY	110,20							
I6W2	ARKE GREY	110,20							
I6W5	ARKE IVORY	112,30							

60x120 (24"x48") Decoro Line 3D - 9 mm - Rettificato

■ 3D

I6B4	ARKE BEIGE	92,20	MQ	2	1,44	31,93	50,40	1.138,00	35
I6B2	ARKE GREY	92,20							
I6B5	ARKE IVORY	92,20							

30x60 (12"x24") Mosaico multispessore - 9 mm - Rettificato

□ Spazzolato R10

I6M1	ARKE ANTHRACITE	80,30	PZ	4	0,72	18,00	17,28	445,00	24
I6M4	ARKE BEIGE	80,30							
I6M3	ARKE CLAY	80,30							
I6M2	ARKE GREY	80,30							
I6M5	ARKE IVORY	80,30							

Venduti solo a scatole complete / Only full boxes sold /
Vendus par boite complete / Nur volle Karton

Da posare senza stuccatura / To be installed without grouting / A poser sans mastic / Ohne Ausfugung zu verlegen

Size	Code	Colour	Euro	U.M.	Pcs / Box	Mq / Box	Kg / Box	Mq / Pallet	Kg / Pallet	Box / Pallet
------	------	--------	------	------	-----------	----------	----------	-------------	-------------	--------------

ARKE'

EFFETTO PIETRA - STONE EFFECT - EFFET PIERRE - STEIN EFFEKT

30x60 (12"x24") Strips - 9 mm - Rettificato

□ Spazzolato R10

I6T1	ARKE ANTHRACITE	31,90	PZ	4	0,72	16,04	21,60	494,20	30
I6T4	ARKE BEIGE	31,90							
I6T3	ARKE CLAY	31,90							
I6T2	ARKE GREY	31,90							
I6T5	ARKE IVORY	31,90							

Venduti solo a scatole complete / Only full boxes sold /
Vendus par boite complete / Nur volle Karton



50x50 (20"x20") Palladiana - 9 mm - Rettificato

▲ Structured R11

I6P1	ARKE ANTHRACITE	59,70	PZ	1	0,25	4,86	20,00	401,80	80
I6P4	ARKE BEIGE	59,70							
I6P3	ARKE CLAY	59,70							
I6P2	ARKE GREY	59,70							
I6P5	ARKE IVORY	59,70							

Venduti solo a scatole complete / Only full boxes sold /
Vendus par boite complete / Nur volle Karton

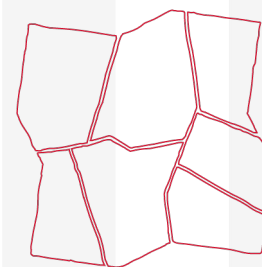

30x30 (12"x12") Mosaico listelli - 9 mm - Rettificato

□ Spazzolato R10

I61M	ARKE ANTHRACITE	20,60	PZ	11	0,99	19,25	35,64	706,00	36
I64M	ARKE BEIGE	20,60							
I63M	ARKE CLAY	20,60							
I62M	ARKE GREY	20,60							
I65M	ARKE IVORY	20,60							

Venduti solo a scatole complete / Only full boxes sold /
Vendus par boite complete / Nur volle Karton

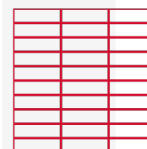

33x120x4 (13"x48") Scalino incollato - 9 mm - Rettificato

□ Spazzolato R10

I6Q1	ARKE ANTHRACITE	234,80	PZ	2	0,79	18,40	19,01	454,60	24
I6Q4	ARKE BEIGE	234,80							
I6Q3	ARKE CLAY	234,80							
I6Q2	ARKE GREY	234,80							
I6Q5	ARKE IVORY	234,80							

Lavorato su richiesta e venduto solo a scatole complete / Manufactured upon request
and only full boxes sold / Seulement à la demande et vendus par boite complete / Nur
auf Anfrage und nur volle Karton

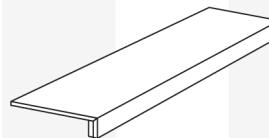

ARKE'

Size	Code	Colour	Euro	U.M.	Pcs / Box	Mq / Box	Kg / Box	Mq / Pallet	Kg / Pallet	Box / Pallet
------	------	--------	------	------	--------------	-------------	-------------	----------------	----------------	-----------------

ARKE'

EFFETTO PIETRA - STONE EFFECT - EFFET PIERRE - STEIN EFFEKT

33x120x4 (13"x48") Scalino angolare incollato - 9 mm - Rettificato

▣ Spazzolato R10

I6X1	ARKE ANTHRACITE ANG. DX	258,50	PZ	1	0,40	9,00	9,50	238,60	24
I6Y1	ARKE ANTHRACITE ANG. SX	258,50							
I6X4	ARKE BEIGE ANG. DX	258,50							
I6Y4	ARKE BEIGE ANG. SX	258,50							
I6X3	ARKE CLAY ANG. DX	258,50							
I6Y3	ARKE CLAY ANG. SX	258,50							
I6X2	ARKE GREY ANG. DX	258,50							
I6Y2	ARKE GREY ANG. SX	258,50							
I6X5	ARKE IVORY ANG. DX	258,50							
I6Y5	ARKE IVORY ANG. SX	258,50							

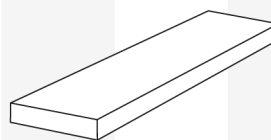

Lavorato su richiesta e venduto solo a scatole complete / Manufactured upon request and only full boxes sold / Seulement à la demande et vendus par boîte complete / Nur auf Anfrage und nur volle Karton

33x60x4 (13"x24") Scalino incollato - 9 mm - Rettificato

▲ Structured R11

S116	ARKE ANTHRACITE	112,80	PZ	4	0,79	21,70	19,01	533,80	24
S416	ARKE BEIGE	112,80							
S316	ARKE CLAY	112,80							
S216	ARKE GREY	112,80							
S516	ARKE IVORY	112,80							

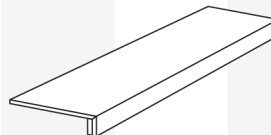

Lavorato su richiesta e venduto solo a scatole complete / Manufactured upon request and only full boxes sold / Seulement à la demande et vendus par boîte complete / Nur auf Anfrage und nur volle Karton

33x33x4 (13"x13") Scalino angolare incollato - 9 mm - Rettificato

▲ Structured R11

V116	ARKE ANTHRACITE	138,00	PZ	4	0,44	14,48	13,07	447,40	30
V416	ARKE BEIGE	138,00							
V316	ARKE CLAY	138,00							
V216	ARKE GREY	138,00							
V516	ARKE IVORY	138,00							

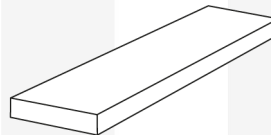

Lavorato su richiesta e venduto solo a scatole complete / Manufactured upon request and only full boxes sold / Seulement à la demande et vendus par boîte complete / Nur auf Anfrage und nur volle Karton

ARKE'

Size	Code	Colour	Euro	U.M.	Pcs / Box	Mq / Box	Kg / Box	Mq / Pallet	Kg / Pallet	Box / Pallet
------	------	--------	------	------	--------------	-------------	-------------	----------------	----------------	-----------------

ARKE'

EFFETTO PIETRA - STONE EFFECT - EFFET PIERRE - STEIN EFFEKT

4,6x120 (1.80"x48") Battiscopa - 9 mm - Rettificato

☐ Spazzolato R10

					Mt				
I6R1	ARKE ANTHRACITE	24,70	PZ	6	7,20	7,80	345,60	387,40	48
I6R4	ARKE BEIGE	24,70							
I6R3	ARKE CLAY	24,70							
I6R2	ARKE GREY	24,70							
I6R5	ARKE IVORY	24,70							

Venduti solo a scatole complete / Only full boxes sold /
Vendus par boîte complete / Nur volle Karton



7,2x60 (2.80"x24") Battiscopa - 9 mm - Rettificato

☐ Spazzolato R10

					Mt				
I61Y	ARKE ANTHRACITE	11,80	PZ	10	6,00	10,48	480,00	851,40	48
I64Y	ARKE BEIGE	11,80							
I63Y	ARKE CLAY	11,80							
I62Y	ARKE GREY	11,80							
I65Y	ARKE IVORY	11,80							

Venduti solo a scatole complete / Only full boxes sold /
Vendus par boîte complete / Nur volle Karton



ARKE'

Size	Code	Colour	Euro	U.M.	Pcs / Box	Mq / Box	Kg / Box	Mq / Pallet	Kg / Pallet	Box / Pallet
------	------	--------	------	------	-----------	----------	----------	-------------	-------------	--------------

BRYSTONE

EFFETTO PIETRA - STONE EFFECT - EFFET PIERRE - STEIN EFFEKT

120x278 (48"x110") (119,5x119,5)* - 6 mm - Rettificato

● Natural R9

DYA2	BRYSTONE GOLD	122,80	MQ	1	3,32	49,56	59,80	990,08	18
DYA3	BRYSTONE IVORY	129,20							

Addebito cassa leggera (max7pz) (prezzo netto) / Light crate charge (max7pz) (net price) / Débit de caisse (max7pz) (prix net) / Kasse belasten (max7pz) (Nettopreis) - € 100
 Addebito cassa (prezzo netto) / Crate charge (net price) / Palette supplémentaire (prix net) / Aufpreispalette (Nettopreis) - € 160
 Addebito cavalletto 18pz (prezzo netto) / Extra rack 18pcs (net price) / Chevalet supplémentaire 18pcs (prix net) / Aufpreisgestell 18St (Nettopreis) - € 270
 Addebito cavalletto 42pz (prezzo netto) / Extra rack 42pcs (net price) / Chevalet supplémentaire 42pcs (prix net) / Aufpreisgestell 42St (Nettopreis) - € 270

120x120 (48"x48") (119,5x119,5)* - 9 mm - Rettificato

● Natural R9

DYC4	BRYSTONE AVANA	102,90	MQ	2	2,86	60,80	57,12	1.251,00	20
DYC2	BRYSTONE GOLD	98,00							
DYC1	BRYSTONE GREY	98,00							
DYC3	BRYSTONE IVORY	102,90							
DYC5	BRYSTONE WHITE	102,90							

BRYSTONE

60x120 (24"x48") - 9 mm - Rettificato

● Natural R9

DYD4	BRYSTONE AVANA	86,30	MQ	2	1,44	31,93	50,40	1.138,00	35
DYD2	BRYSTONE GOLD	83,10							
DYD1	BRYSTONE GREY	83,10							
DYD3	BRYSTONE IVORY	86,30							
DYD5	BRYSTONE WHITE	86,30							

■ Structured R10

DY4D	BRYSTONE AVANA	86,30							
DY2D	BRYSTONE GOLD	83,10							
DY1D	BRYSTONE GREY	83,10							
DY3D	BRYSTONE IVORY	86,30							
DY5D	BRYSTONE WHITE	86,30							

Size	Code	Colour	Euro	U.M.	Pcs / Box	Mq / Box	Kg / Box	Mq / Pallet	Kg / Pallet	Box / Pallet
------	------	--------	------	------	-----------	----------	----------	-------------	-------------	--------------

BRYSTONE

EFFETTO PIETRA - STONE EFFECT - EFFET PIERRE - STEIN EFFEKT

30x120 (12"x48") - 9 mm - Rettificato

● Natural R9

DYE4	BRYSTONE AVANA	88,10	MQ	4	1,44	31,48	51,84	1.154,28	36
DYE2	BRYSTONE GOLD	84,80							
DYE1	BRYSTONE GREY	84,80							
DYE3	BRYSTONE IVORY	88,10							
DYE5	BRYSTONE WHITE	88,10							

80x80 (32"x32") - 9 mm - Rettificato

● Natural R9

DYG4	BRYSTONE AVANA	76,20	MQ	2	1,28	25,60	61,44	1.253,80	48
DYG2	BRYSTONE GOLD	73,20							
DYG1	BRYSTONE GREY	73,20							
DYG3	BRYSTONE IVORY	76,20							
DYG5	BRYSTONE WHITE	76,20							

60x60 (24"x24") - 9 mm - Rettificato

● Natural R9

DYH4	BRYSTONE AVANA	63,80	MQ	3	1,08	21,00	43,20	853,00	40
DYH2	BRYSTONE GOLD	61,20							
DYH1	BRYSTONE GREY	61,20							
DYH3	BRYSTONE IVORY	63,80							
DYH5	BRYSTONE WHITE	63,80							

■ Structured R10

DY4H	BRYSTONE AVANA	63,80							
DY2H	BRYSTONE GOLD	61,20							
DY1H	BRYSTONE GREY	61,20							
DY3H	BRYSTONE IVORY	63,80							
DY5H	BRYSTONE WHITE	63,80							

BRYSTONE

Size	Code	Colour	Euro	U.M.	Pcs / Box	Mq / Box	Kg / Box	Mq / Pallet	Kg / Pallet	Box / Pallet
------	------	--------	------	------	-----------	----------	----------	-------------	-------------	--------------

BRYSTONE

EFFETTO PIETRA - STONE EFFECT - EFFET PIERRE - STEIN EFFEKT

30x60 (12"x24") - 9 mm - Rettificato

● Natural R9

DYI4	BRYSTONE AVANA	52,90	MQ	7	1,26	25,00	50,40	1.016,00	40
DYI2	BRYSTONE GOLD	51,10							
DYI1	BRYSTONE GREY	51,10							
DYI3	BRYSTONE IVORY	52,90							
DYI5	BRYSTONE WHITE	52,90							

■ Structured R10

DY4I	BRYSTONE AVANA	52,90							
DY2I	BRYSTONE GOLD	51,10							
DY1I	BRYSTONE GREY	51,10							
DY3I	BRYSTONE IVORY	52,90							
DY5I	BRYSTONE WHITE	52,90							

9,7x60 (3.80"x24") - 9 mm - Rettificato

● Natural R9

DY04	BRYSTONE AVANA	73,40	MQ	10	0,58	12,75	34,92	781,00	60
DYL2	BRYSTONE GOLD	70,80							
DYL1	BRYSTONE GREY	70,80							
DY03	BRYSTONE IVORY	73,40							
DY05	BRYSTONE WHITE	73,40							

60x90 (24"x36") - 20 mm - Rettificato

▲ Structured R11

DYW2	BRYSTONE GOLD	108,70	MQ	2	1,08	48,50	25,92	1.182,00	24
DYW1	BRYSTONE GREY	108,70							
DYW3	BRYSTONE IVORY	112,20							

Disponibile anche con pallettizzazione a 18 scatole. Verificare all'ordine la disponibilità / Also available with 18 boxes palletization. Check availability when ordering / Également disponible avec une palettisation de 18 caisses. Vérifier la disponibilité lors de la commande / Auch mit 18 Kartons Palettierung erhältlich. Verfügbarkeit bei Bestellung prüfen

80x80 (32"x32") - 20 mm - Rettificato

▲ Structured R11

DY2W	BRYSTONE GOLD	114,90	MQ	1	0,64	28,00	26,88	1.272,40	42
DY1W	BRYSTONE GREY	114,90							
DY5W	BRYSTONE WHITE	119,50							

BRYSTONE

Size	Code	Colour	Euro	U.M.	Pcs / Box	Mq / Box	Kg / Box	Mq / Pallet	Kg / Pallet	Box / Pallet
------	------	--------	------	------	-----------	----------	----------	-------------	-------------	--------------

BRYSTONE

EFFETTO PIETRA - STONE EFFECT - EFFET PIERRE - STEIN EFFEKT

60x120 (24"x48") Decoro Crossing 3D - 9 mm - Rettificato

■ 3D

DY2B	BRYSTONE GOLD	88,70	MQ	2	1,44	31,93	50,40	1.139,00	35
DY3B	BRYSTONE IVORY	92,40							

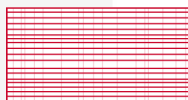

9,7x60 (3.80"x24") Listello Up - 9 mm - Rettificato

● Natural R9

DYU4	BRYSTONE AVANA	121,20	MQ	8	0,47	10,48	27,96	641,80	60
DYU2	BRYSTONE GOLD	117,90							
DYU1	BRYSTONE GREY	117,90							
DYU3	BRYSTONE IVORY	121,20							
DYU5	BRYSTONE WHITE	121,20							

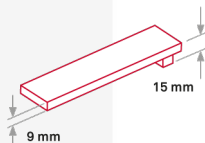

30x30 (12"x12") Mosaico T100 (2,8x2,8) - 9 mm - Rettificato

● Natural R9

DYM4	BRYSTONE AVANA	27,80	PZ	6	0,54	11,20	25,00	550,60	48
DYM2	BRYSTONE GOLD	27,80							
DYM1	BRYSTONE GREY	27,80							
DYM3	BRYSTONE IVORY	27,80							
DYM5	BRYSTONE WHITE	27,80							



33x120x4 (13"x48") Scalino incollato - 9 mm - Rettificato

● Natural R9

DYQ4	BRYSTONE AVANA	235,10	PZ	2	0,79	18,40	19,01	454,60	24
DYQ2	BRYSTONE GOLD	235,10							
DYQ1	BRYSTONE GREY	235,10							
DYQ3	BRYSTONE IVORY	235,10							
DYQ5	BRYSTONE WHITE	235,10							

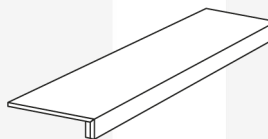

Venduti solo a scatole complete / Only full boxes sold /
Vendus par boite complete / Nur volle Karton

Lavorato su richiesta e venduto solo a scatole complete / Manufactured upon request
and only full boxes sold / Seulement à la demande et vendus par boite complete / Nur
auf Anfrage und nur volle Karton

BRYSTONE

Size	Code	Colour	Euro	U.M.	Pcs / Box	Mq / Box	Kg / Box	Mq / Pallet	Kg / Pallet	Box / Pallet
------	------	--------	------	------	-----------	----------	----------	-------------	-------------	--------------

BRYSTONE

EFFETTO PIETRA - STONE EFFECT - EFFET PIERRE - STEIN EFFEKT

33x120x4 (13"x48") Scalino angolare incollato - 9 mm - Rettificato

● Natural R9

DYX4	BRYSTONE AVANA ANG. DX	258,50	PZ	1	0,40	9,00	9,50	238,60	24
DYY4	BRYSTONE AVANA ANG. SX	258,50							
DYX2	BRYSTONE GOLD ANG. DX	258,50							
DYY2	BRYSTONE GOLD ANG. SX	258,50							
DYX1	BRYSTONE GREY ANG. DX	258,50							
DYY1	BRYSTONE GREY ANG. SX	258,50							
DYX3	BRYSTONE IVORY ANG. DX	258,50							
DYY3	BRYSTONE IVORY ANG. SX	258,50							
DYX5	BRYSTONE WHITE ANG. DX	258,50							
DYY5	BRYSTONE WHITE ANG. SX	258,50							

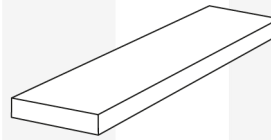

Lavorato su richiesta e venduto solo a scatole complete / Manufactured upon request and only full boxes sold / Seulement à la demande et vendus par boîte complete / Nur auf Anfrage und nur volle Karton

BRYSTONE

33x60x4 (13"x24") Scalino incollato - 9 mm - Rettificato

● Natural R9

DYS4	BRYSTONE AVANA	113,20	PZ	4	0,79	21,70	19,01	533,80	24
DYS1	BRYSTONE GREY	113,20							
DYS3	BRYSTONE IVORY	113,20							
DYS2	BRYSTONE IVORY	113,20							
DYS5	BRYSTONE WHITE	113,20							

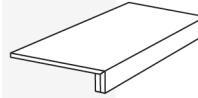

Lavorato su richiesta e venduto solo a scatole complete / Manufactured upon request and only full boxes sold / Seulement à la demande et vendus par boîte complete / Nur auf Anfrage und nur volle Karton

33x33x4 (13"x13") Scalino angolare incollato - 9 mm - Rettificato

● Natural R9

DYV4	BRYSTONE AVANA	138,30	PZ	4	0,44	14,48	13,07	447,40	30
DYV2	BRYSTONE GOLD	138,30							
DYV1	BRYSTONE GREY	138,30							
DYV3	BRYSTONE IVORY	138,30							
DYV5	BRYSTONE WHITE	138,30							



Lavorato su richiesta e venduto solo a scatole complete / Manufactured upon request and only full boxes sold / Seulement à la demande et vendus par boîte complete / Nur auf Anfrage und nur volle Karton

4,6x120 (1.80"x48") Battiscopa - 9 mm - Rettificato

● Natural R9

DY4R	BRYSTONE AVANA	24,70	PZ	6	7,20	7,80	345,60	387,40	48
DY2R	BRYSTONE GOLD	24,70							
DY1R	BRYSTONE GREY	24,70							
DY3R	BRYSTONE IVORY	24,70							
DY5R	BRYSTONE WHITE	24,70							



Venduti solo a scatole complete / Only full boxes sold / Vendus par boîte complete / Nur volle Karton

Size	Code	Colour	Euro	U.M.	Pcs / Box	Mq / Box	Kg / Box	Mq / Pallet	Kg / Pallet	Box / Pallet
------	------	--------	------	------	--------------	-------------	-------------	----------------	----------------	-----------------

BRYSTONE

EFFETTO PIETRA - STONE EFFECT - EFFET PIERRE - STEIN EFFEKT

7x80 (2.75"x32") Battiscopa - 9 mm - Rettificato

● Natural R9

					Mt				
R4DY	BRYSTONE AVANA	13,30	PZ	8	6,40	9,30	460,80	682,60	72
R2DY	BRYSTONE GOLD	13,30							
R1DY	BRYSTONE GREY	13,30							
R3DY	BRYSTONE IVORY	13,30							
R5DY	BRYSTONE WHITE	13,30							

Venduti solo a scatole complete / Only full boxes sold /
Vendus par boîte complete / Nur volle Karton



7,2x60 (2.80"x24") Battiscopa - 9 mm - Rettificato

● Natural R9

					Mt				
DYR4	BRYSTONE AVANA	11,70	PZ	10	6,00	10,48	480,00	851,40	80
DYR2	BRYSTONE GOLD	11,70							
DYR1	BRYSTONE GREY	11,70							
DYR3	BRYSTONE IVORY	11,70							
DYR5	BRYSTONE WHITE	11,70							

Venduti solo a scatole complete / Only full boxes sold /
Vendus par boîte complete / Nur volle Karton



BRYSTONE

Size	Code	Colour	Euro	U.M.	Pcs / Box	Mq / Box	Kg / Box	Mq / Pallet	Kg / Pallet	Box / Pallet
------	------	--------	------	------	-----------	----------	----------	-------------	-------------	--------------

CHORUS

EFFETTO PIETRA - STONE EFFECT - EFFET PIERRE - STEIN EFFEKT

120x120 (48"x48") (119,5x119,5)* - 9 mm - Rettificato

● Natural R9

CE00	CHORUS BEIGE	96,80	MQ	2	2,86	60,80	57,12	1.251,00	20
COA1	CHORUS SILVER	96,80							
CO41	CHORUS WHITE	99,40							

60x120 (24"x48") - 9 mm - Rettificato

● Natural R9

CO61	CHORUS BEIGE	79,90	MQ	2	1,44	31,93	50,40	1.138,00	35
CO60	CHORUS GREY	81,90							
CO62	CHORUS SILVER	79,90							
CO65	CHORUS WHITE	81,90							

▲ Grip R11

OC64	CHORUS BEIGE	79,90							
CO00	CHORUS GREY	81,90							
CO53	CHORUS SILVER	79,90							
CO84	CHORUS WHITE	81,90							

60x60 (24"x24") - 9 mm - Rettificato

● Natural R9

36CO	CHORUS BEIGE	58,90	MQ	3	1,08	21,00	43,20	853,00	40
CO05	CHORUS GREY	60,40							
COA7	CHORUS SILVER	58,90							
CO55	CHORUS WHITE	60,40							

▲ Grip R11

OC65	CHORUS BEIGE	58,90							
CO10	CHORUS GREY	60,40							
CO51	CHORUS SILVER	58,90							
CO83	CHORUS WHITE	60,40							

CHORUS

Size	Code	Colour	Euro	U.M.	Pcs / Box	Mq / Box	Kg / Box	Mq / Pallet	Kg / Pallet	Box / Pallet
------	------	--------	------	------	-----------	----------	----------	-------------	-------------	--------------

CHORUS

EFFETTO PIETRA - STONE EFFECT - EFFET PIERRE - STEIN EFFEKT

30x60 (12"x24") - 9 mm - Rettificato

● Natural R9

CO1D	CHORUS BEIGE	48,60	MQ	7	1,26	25,00	50,40	1.016,00	40
CO2D	CHORUS GREY	49,90							
CO3D	CHORUS SILVER	48,60							
CO5D	CHORUS WHITE	49,90							

▲ Grip R11

CO1K	CHORUS BEIGE	48,60							
CO2K	CHORUS GREY	49,90							
CO3K	CHORUS SILVER	48,60							
CO5K	CHORUS WHITE	49,90							

9,7x60 (3.80"x24") - 9 mm - Rettificato

● Natural R9

CO46	CHORUS BEIGE	80,90	MQ	10	0,58	12,75	34,92	781,00	60
CO70	CHORUS GREY	82,70							
COA9	CHORUS SILVER	80,90							
CO57	CHORUS WHITE	82,70							

CHORUS

60x120 (24"x48") - 20 mm - Rettificato

▲ Grip R11

CO86	CHORUS BEIGE	116,80	MQ	1	0,72	33,75	25,20	1.202,25	35
CO54	CHORUS SILVER	116,80							
CO48	CHORUS WHITE	120,30							

60x120 (24"x48") Decoro Crossing 3D - 9 mm - Rettificato

■ 3D

CO4C	CHORUS SILVER	85,40	MQ	2	1,44	31,93	50,40	1.139,00	35
CO5B	CHORUS WHITE	87,60							

Size	Code	Colour	Euro	U.M.	Pcs / Box	Mq / Box	Kg / Box	Mq / Pallet	Kg / Pallet	Box / Pallet
------	------	--------	------	------	-----------	----------	----------	-------------	-------------	--------------

CHORUS

EFFETTO PIETRA - STONE EFFECT - EFFET PIERRE - STEIN EFFEKT

9,7x60 (3.80"x24") Listello Up - 9 mm - Rettificato

● Natural R9

C075	CHORUS BEIGE	114,60	MQ	8	0,47	10,48	27,96	641,80	60
C068	CHORUS GREY	117,40							
C073	CHORUS SILVER	114,60							
C074	CHORUS WHITE	117,40							

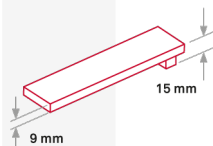

30x30 (12"x12") Mosaico T100 (2,8x2,8) - 9 mm - Rettificato

● Natural R9

C05M	CHORUS BEIGE	28,70	PZ	6	0,54	11,20	25,00	550,60	48
C02M	CHORUS GREY	28,70							
C03M	CHORUS SILVER	28,70							
C04M	CHORUS WHITE	28,70							

Venduti solo a scatole complete / Only full boxes sold /
Vendus par boite complete / Nur volle Karton

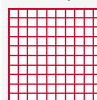

33x120x4 (13"x48") Scalino incollato - 9 mm - Rettificato

● Natural R9

COV1	CHORUS BEIGE	235,10	PZ	2	0,79	18,40	19,01	454,60	24
COV7	CHORUS GREY	235,10							
COV2	CHORUS SILVER	235,10							
COV5	CHORUS WHITE	235,10							

Lavorato su richiesta e venduto solo a scatole complete / Manufactured upon request
and only full boxes sold / Seulement à la demande et vendus par boite complete / Nur
auf Anfrage und nur volle Karton

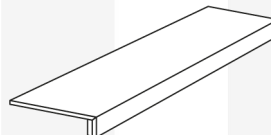

33x120x4 (13"x48") Scalino angolare incollato - 9 mm - Rettificato

● Natural R9

COD1	CHORUS BEIGE ANG. DX	258,50	PZ	1	0,40	9,00	9,50	238,60	24
COs1	CHORUS BEIGE ANG. SX	258,50							
COD7	CHORUS GREY ANG. DX	258,50							
COS7	CHORUS GREY ANG. SX	258,50							
COD2	CHORUS SILVER ANG. DX	258,50							
COS2	CHORUS SILVER ANG. SX	258,50							
COS5	CHORUS WHITE ANG. SX	258,50							
COD5	CHORUS WHITE ANG. DX	258,50							

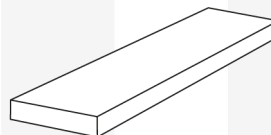

Size	Code	Colour	Euro	U.M.	Pcs / Box	Mq / Box	Kg / Box	Mq / Pallet	Kg / Pallet	Box / Pallet
------	------	--------	------	------	-----------	----------	----------	-------------	-------------	--------------

CHORUS

EFFETTO PIETRA - STONE EFFECT - EFFET PIERRE - STEIN EFFEKT

33x60x4 (13"x24") Scalino incollato - 9 mm - Rettificato

● Natural R9

OC15	CHORUS BEIGE	113,20	PZ	4	0,79	21,70	19,01	533,80	24
OC11	CHORUS GREY	113,20							
OC13	CHORUS SILVER	113,20							
OC14	CHORUS WHITE	113,20							

Lavorato su richiesta e venduto solo a scatole complete / Manufactured upon request and only full boxes sold / Seulement à la demande et vendus par boîte complete / Nur auf Anfrage und nur volle Karton

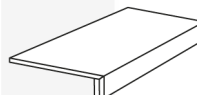

33x33x4 (13"x13") Scalino angolare incollato - 9 mm - Rettificato

● Natural R9

OC21	CHORUS BEIGE	138,30	PZ	4	0,44	14,48	13,07	447,40	30
OC17	CHORUS GREY	138,30							
OC18	CHORUS SILVER	138,30							
OC19	CHORUS WHITE	138,30							

Lavorato su richiesta e venduto solo a scatole complete / Manufactured upon request and only full boxes sold / Seulement à la demande et vendus par boîte complete / Nur auf Anfrage und nur volle Karton



7,2x60 (2.80"x24") Battiscopa - 9 mm - Rettificato

● Natural R9

				Mt						
COB6	CHORUS BEIGE	11,70	PZ	10	6,00	10,48	480,00	851,40	80	
COB2	CHORUS GREY	11,70								
COB4	CHORUS SILVER	11,70								
COB5	CHORUS WHITE	11,70								

Venduti solo a scatole complete / Only full boxes sold / Vendus par boîte complete / Nur volle Karton



CHORUS

Size	Code	Colour	Euro	U.M.	Pcs / Box	Mq / Box	Kg / Box	Mq / Pallet	Kg / Pallet	Box / Pallet
------	------	--------	------	------	-----------	----------	----------	-------------	-------------	--------------

DISCOVERY

EFFETTO PIETRA - STONE EFFECT - EFFET PIERRE - STEIN EFFEKT

22,5x45,3 (9"x18") - 8,5 mm - Non rettificato

▲ Structured R11

6ZHT	DISCOVERY ARDESIA GREY	42,20	MQ	13	1,32	22,80	52,65	912,00	40
5ZHT	DISCOVERY ARDESIA SILVER	43,30							
4ZHT	DISCOVERY COTTO BEIGE	42,20							
3ZHT	DISCOVERY COTTO RED	43,30							
1ZHT	DISCOVERY LECCESE IVORY	42,20							
2ZHT	DISCOVERY LECCESE TAUPE	43,30							

15x30x4 Terminale L monolitico - 8,5 mm - Non rettificato

▲ Structured R11

HTT6	DISCOVERY ARDESIA GREY	19,70	PZ	8	0,36	9,00	17,28	445,00	48
HTT5	DISCOVERY ARDESIA SILVER	19,70							
HTT4	DISCOVERY COTTO BEIGE	19,70							
HT3T	DISCOVERY COTTO RED	19,70							
HTT1	DISCOVERY LECCESE IVORY	19,70							
HTT2	DISCOVERY LECCESE TAUPE	19,70							

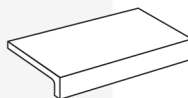

7,2x45,3 (2.80"x18") Battiscopa - 9 mm - Non rettificato

▲ Structured R11

R6HT	DISCOVERY ARDESIA GREY	7,20	PZ	12	5,44	7,90	456,62	676,60	84
R5HT	DISCOVERY ARDESIA SILVER	7,20							
R4HT	DISCOVERY COTTO BEIGE	7,20							
3RHT	DISCOVERY COTTO RED	7,20							
1RHT	DISCOVERY LECCESE IVORY	7,20							
R2HT	DISCOVERY LECCESE TAUPE	7,20							

Mt

Venduti solo a scatole complete / Only full boxes sold /
Vendus par boîte complete / Nur volle Karton



DISCOVERY

Size	Code	Colour	Euro	U.M.	Pcs / Box	Mq / Box	Kg / Box	Mq / Pallet	Kg / Pallet	Box / Pallet
------	------	--------	------	------	--------------	-------------	-------------	----------------	----------------	-----------------

DISTRICT

EFFETTO CEMENTO - CONCRETE EFFECT - EFFET CIMENT - ZEMENT EFFEKT

120x278 (48"x110") (119,5x278)* - 6 mm - Rettificato

● Natural R9

IBA1	DISTRICT GREIGE	129,30	MQ	1	3,32	49,56	59,80	990,08	18
IBA2	DISTRICT WHITE	129,30							

Addebito cassa leggera (max7pz) (prezzo netto) / Light crate charge (max7pz) (net price) / Débit de caisse (max7pz) (prix net) / Kasse belasten (max7pz) (Nettopreis) - € 100
 Addebito cassa (prezzo netto) / Crate charge (net price) / Palette supplémentaire (prix net) / Aufpreispalette (Nettopreis) - € 160
 Addebito cavalletto 18pz (prezzo netto) / Extra rack 18pcs (net price) / Chevalet supplémentaire 18pcs (prix net) / Aufpreisgestell 18St (Nettopreis) - € 270
 Addebito cavalletto 42pz (prezzo netto) / Extra rack 42pcs (net price) / Chevalet supplémentaire 42pcs (prix net) / Aufpreisgestell 42St (Nettopreis) - € 270

120x120 (48"x48") (119,5x119,5)* - 9 mm - Rettificato

□ Spazzolato R10

IBC1	DISTRICT GREIGE	102,50	MQ	2	2,86	60,80	57,12	1.251,00	20
IBC5	DISTRICT GREY	102,50							
IBC3	DISTRICT IVORY	102,50							
IBC4	DISTRICT SILVER	102,50							
IB2C	DISTRICT WHITE	102,50							

DISTRICT

60x120 (24"x48") - 9 mm - Rettificato

□ Spazzolato R10

IBD1	DISTRICT GREIGE	83,40	MQ	2	1,44	31,93	50,40	1.138,00	35
IBD5	DISTRICT GREY	83,40							
IBD3	DISTRICT IVORY	83,40							
IBD4	DISTRICT SILVER	83,40							
IBD2	DISTRICT WHITE	83,40							

80x80 (32"x32") - 9 mm - Rettificato

□ Spazzolato R10

IBG1	DISTRICT GREIGE	77,30	MQ	2	1,28	25,60	61,44	1.253,80	48
IBG5	DISTRICT GREY	77,30							
IBG3	DISTRICT IVORY	77,30							
IBG4	DISTRICT SILVER	77,30							
IBG2	DISTRICT WHITE	77,30							

Size	Code	Colour	Euro	U.M.	Pcs / Box	Mq / Box	Kg / Box	Mq / Pallet	Kg / Pallet	Box / Pallet
------	------	--------	------	------	-----------	----------	----------	-------------	-------------	--------------

DISTRICT

EFFETTO CEMENTO - CONCRETE EFFECT - EFFET CIMENT - ZEMENT EFFEKT

60x60 (24"x24") - 9 mm - Rettificato

□ Spazzolato R10

IBH1	DISTRICT GREIGE	61,30	MQ	3	1,08	21,00	43,20	853,00	40
IBH5	DISTRICT GREY	61,30							
IBH3	DISTRICT IVORY	61,30							
IBH4	DISTRICT SILVER	61,30							
IBH2	DISTRICT WHITE	61,30							

▲ Structured R11

H1DB	DISTRICT GREIGE	61,30							
H5IB	DISTRICT GREY	61,30							
H3IB	DISTRICT IVORY	61,30							
H4IB	DISTRICT SILVER	61,30							
H2IB	DISTRICT WHITE	61,30							

30x60 (12"x24") - 9 mm - Rettificato

□ Spazzolato R10

IBI1	DISTRICT GREIGE	51,00	MQ	7	1,26	25,00	50,40	1.016,00	40
IBI5	DISTRICT GREY	51,00							
IBI3	DISTRICT IVORY	51,00							
IBI4	DISTRICT SILVER	51,00							
IBI2	DISTRICT WHITE	51,00							

▲ Structured R11

1IIB	DISTRICT GREIGE	51,00							
5IIB	DISTRICT GREY	51,00							
3IIB	DISTRICT IVORY	51,00							
4IIB	DISTRICT SILVER	51,00							
2IIB	DISTRICT WHITE	51,00							

80x80 (32"x32") - 20 mm - Rettificato

▲ Structured R11

IBW1	DISTRICT GREIGE	114,80	MQ	1	0,64	28,00	26,88	1.272,40	42
IBW5	DISTRICT GREY	114,80							
IBW3	DISTRICT IVORY	114,80							
IBW4	DISTRICT SILVER	114,80							
IBW2	DISTRICT WHITE	114,80							

DISTRICT

Size	Code	Colour	Euro	U.M.	Pcs / Box	Mq / Box	Kg / Box	Mq / Pallet	Kg / Pallet	Box / Pallet
------	------	--------	------	------	--------------	-------------	-------------	----------------	----------------	-----------------

DISTRICT

EFFETTO CEMENTO - CONCRETE EFFECT - EFFET CIMENT - ZEMENT EFFEKT

30x30 (12"x12") Mosaico T100 (2,8x2,8) - 9 mm - Rettificato

□ Spazzolato R10

IBM1	DISTRICT GREIGE	27,80	PZ	6	0,54	11,20	25,00	550,60	48
IBM5	DISTRICT GREY	27,80							
IBM3	DISTRICT IVORY	27,80							
IBM4	DISTRICT SILVER	27,80							
IBM2	DISTRICT WHITE	27,80							

Venduti solo a scatole complete / Only full boxes sold /
Vendus par boîte complete / Nur volle Karton

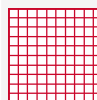

33x120x4 (13"x48") Scalino incollato - 9 mm - Rettificato

□ Spazzolato R10

IBQ1	DISTRICT GREIGE	235,40	PZ	2	0,79	18,40	19,01	454,60	24
IBQ5	DISTRICT GREY	235,40							
IBQ3	DISTRICT IVORY	235,40							
IBQ4	DISTRICT SILVER	235,40							
IBQ2	DISTRICT WHITE	235,40							

Lavorato su richiesta e venduto solo a scatole complete / Manufactured upon request
and only full boxes sold / Seulement à la demande et vendus par boîte complete / Nur
auf Anfrage und nur volle Karton

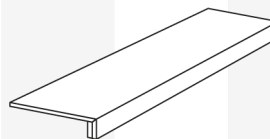

33x120x4 (13"x48") Scalino angolare incollato - 9 mm - Rettificato

□ Spazzolato R10

IBX1	DISTRICT GREIGE ANG. DX	258,50	PZ	1	0,40	9,00	9,50	238,60	24
IBY1	DISTRICT GREIGE ANG. SX	258,50							
IBX5	DISTRICT GREY ANG. DX	258,50							
IBY5	DISTRICT GREY ANG. SX	258,50							
IBX3	DISTRICT IVORY ANG. DX	258,50							
IBY3	DISTRICT IVORY ANG. SX	258,50							
IBX4	DISTRICT SILVER ANG. DX	258,50							
IBY4	DISTRICT SILVER ANG. SX	258,50							
IBX2	DISTRICT WHITE ANG. DX	258,50							
IBY2	DISTRICT WHITE ANG. SX	258,50							

Lavorato su richiesta e venduto solo a scatole complete / Manufactured upon request
and only full boxes sold / Seulement à la demande et vendus par boîte complete / Nur
auf Anfrage und nur volle Karton

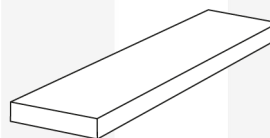

DISTRICT

Size	Code	Colour	Euro	U.M.	Pcs / Box	Mq / Box	Kg / Box	Mq / Pallet	Kg / Pallet	Box / Pallet
------	------	--------	------	------	-----------	----------	----------	-------------	-------------	--------------

DISTRICT

EFFETTO CEMENTO - CONCRETE EFFECT - EFFET CIMENT - ZEMENT EFFEKT

33x60x4 (13"x24") Scalino incollato - 9 mm - Rettificato

▲ Structured R11

S1IB	DISTRICT GREIGE	113,30	PZ	4	0,79	21,70	19,01	533,80	24
S5IB	DISTRICT GREY	113,30							
S3IB	DISTRICT IVORY	113,30							
S4IB	DISTRICT SILVER	113,30							
C2IB	DISTRICT WHITE	113,30							

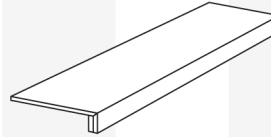

Lavorato su richiesta e venduto solo a scatole complete / Manufactured upon request and only full boxes sold / Seulement à la demande et vendus par boîte complète / Nur auf Anfrage und nur volle Karton

33x33x4 (13"x13") Scalino angolare incollato - 9 mm - Rettificato

▲ Structured R11

V1IB	DISTRICT GREIGE	138,50	PZ	4	0,44	14,48	13,07	447,40	30
V5IB	DISTRICT GREY	138,50							
V3IB	DISTRICT IVORY	138,50							
V4IB	DISTRICT SILVER	138,50							
V2IB	DISTRICT WHITE	138,50							

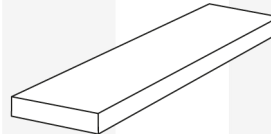

Lavorato su richiesta e venduto solo a scatole complete / Manufactured upon request and only full boxes sold / Seulement à la demande et vendus par boîte complète / Nur auf Anfrage und nur volle Karton

DISTRICT

4,6x120 (1.80"x48") Battiscopa - 9 mm - Rettificato

□ Spazzolato R10

				Mt						
IBR1	DISTRICT GREIGE	24,70	PZ	6	7,20	7,80	345,60	387,40	48	
IBR5	DISTRICT GREY	24,70								
R3IB	DISTRICT IVORY	24,70								
IBR4	DISTRICT SILVER	24,70								
IBR2	DISTRICT WHITE	24,70								



Venduti solo a scatole complete / Only full boxes sold / Vendus par boîte complète / Nur volle Karton

7x80 (2.75"x32") Battiscopa - 9 mm - Rettificato

□ Spazzolato R10

				Mt						
IB1B	DISTRICT GREIGE	13,40	PZ	8	6,40	9,30	460,80	682,60	72	
IB5B	DISTRICT GREY	13,40								
IB3B	DISTRICT IVORY	13,40								
IB4B	DISTRICT SILVER	13,40								
IB2B	DISTRICT WHITE	13,40								



Venduti solo a scatole complete / Only full boxes sold / Vendus par boîte complète / Nur volle Karton

Size	Code	Colour	Euro	U.M.	Pcs / Box	Mq / Box	Kg / Box	Mq / Pallet	Kg / Pallet	Box / Pallet
------	------	--------	------	------	--------------	-------------	-------------	----------------	----------------	-----------------

DISTRICT

EFFETTO CEMENTO - CONCRETE EFFECT - EFFET CIMENT - ZEMENT EFFEKT

7,2x60 (2.80"x24") Battiscopa - 9 mm - Rettificato

Spazzolato R10

					Mt				
IB1Y	DISTRICT GREIGE	11,70	PZ	10	6,00	10,48	480,00	851,40	48
IB5Y	DISTRICT GREY	11,70							
IB3Y	DISTRICT IVORY	11,70							
IB4Y	DISTRICT SILVER	11,70							
IB2Y	DISTRICT WHITE	11,70							

Venduti solo a scatole complete / Only full boxes sold /
Vendus par boîte complete / Nur volle Karton



DISTRICT

Size	Code	Colour	Euro	U.M.	Pcs / Box	Mq / Box	Kg / Box	Mq / Pallet	Kg / Pallet	Box / Pallet
------	------	--------	------	------	-----------	----------	----------	-------------	-------------	--------------

DOLMIX

EFFETTO PIETRA - STONE EFFECT - EFFET PIERRE - STEIN EFFEKT

120x278 (48"x110") (119,5x278)* - 6 mm - Rettificato

● Natural R9

FFA1	DOLMIX GREY	124,00	MQ	1	3,32	49,56	59,80	990,08	18
------	-------------	--------	----	---	------	-------	-------	--------	----



Addebito cassa leggera (max7pz) (prezzo netto) / Light crate charge (max7pz) (net price) / Débit de caisse (max7pz) (prix net) / Kasse belasten (max7pz) (Nettopreis) - € 100
 Addebito cassa (prezzo netto) / Crate charge (net price) / Palette supplémentaire (prix net) / Aufreispalette (Nettopreis) - € 160
 Addebito cavalletto 18pz (prezzo netto) / Extra rack 18pcs (net price) / Chevalet supplémentaire 18pcs (prix net) / Aufpreisgestell 18St (Nettopreis) - € 270
 Addebito cavalletto 42pz (prezzo netto) / Extra rack 42pcs (net price) / Chevalet supplémentaire 42pcs (prix net) / Aufpreisgestell 42St (Nettopreis) - € 270

120x120 (48"x48") (119,5x119,5)* - 9 mm - Rettificato

● Natural R9

FFC1	DOLMIX GREY	99,00	MQ	2	2,86	60,80	57,12	1.251,00	20
FFC4	DOLMIX LIGHT	102,30							

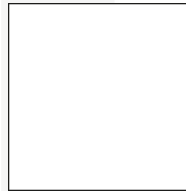

DOLMIX

60x120 (24"x48") - 9 mm - Rettificato

● Natural R9

FFD3	DOLMIX DARK	86,40	MQ	2	1,44	31,93	50,40	1.138,00	35
FFD1	DOLMIX GREY	84,20							
FFD2	DOLMIX LIGHT	86,40							



60x60 (24"x24") - 9 mm - Rettificato

● Natural R9

FFH3	DOLMIX DARK	65,00	MQ	3	1,08	21,00	43,20	853,00	40
FFH1	DOLMIX GREY	62,50							
FFH2	DOLMIX LIGHT	65,00							



120x120 (48"x48") - 20 mm - Rettificato

▲ Structured R11

W1FF	DOLMIX GREY	141,20	MQ	1	1,43	67,10	28,56	1.377,00	20
------	-------------	--------	----	---	------	-------	-------	----------	----

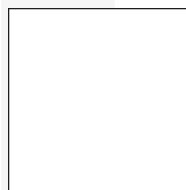

Size	Code	Colour	Euro	U.M.	Pcs / Box	Mq / Box	Kg / Box	Mq / Pallet	Kg / Pallet	Box / Pallet
------	------	--------	------	------	-----------	----------	----------	-------------	-------------	--------------

DOLMIX

EFFETTO PIETRA - STONE EFFECT - EFFET PIERRE - STEIN EFFEKT

60x60 (24"x24") - 20 mm - Rettificato

▲ Structured R11

FF1W	DOLMIX GREY	94,90	MQ	2	0,72	30,70	21,60	934,00	30
------	-------------	-------	----	---	------	-------	-------	--------	----



30x30 (12"x12") Mosaico T36 (4,8x4,8) - 9 mm - Rettificato

● Natural R9

FFM3	DOLMIX DARK	14,00	PZ	10	0,90	17,00	27,00	523,00	30
FFM1	DOLMIX GREY	14,00							
FFM2	DOLMIX LIGHT	14,00							

Venduti solo a scatole complete / Only full boxes sold /
Vendus par boîte complete / Nur volle Karton

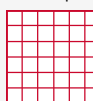

33x120x4 (13"x48") Scalino incollato - 9 mm - Rettificato

● Natural R9

FFQ3	DOLMIX DARK	235,10	PZ	2	0,79	18,40	19,01	454,60	24
FFQ1	DOLMIX GREY	235,10							
FFQ2	DOLMIX LIGHT	235,10							

Lavorato su richiesta e venduto solo a scatole complete / Manufactured upon request
and only full boxes sold / Seulement à la demande et vendus par boîte complete / Nur
auf Anfrage und nur volle Karton

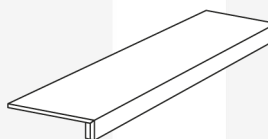

33x120x4 (13"x48") Scalino angolare incollato - 9 mm - Rettificato

● Natural R9

FFX3	DOLMIX DARK ANG. DX	258,50	PZ	1	0,40	9,00	9,50	238,60	24
FFY3	DOLMIX DARK ANG. SX	258,50							
FFX1	DOLMIX GREY ANG. DX	258,50							
FFY1	DOLMIX GREY ANG. SX	258,50							
FFX2	DOLMIX LIGHT ANG. DX	258,50							
FFY2	DOLMIX LIGHT ANG. SX	258,50							

Lavorato su richiesta e venduto solo a scatole complete / Manufactured upon request
and only full boxes sold / Seulement à la demande et vendus par boîte complete / Nur
auf Anfrage und nur volle Karton

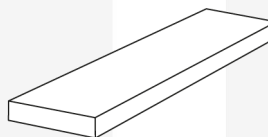

DOLMIX

Size	Code	Colour	Euro	U.M.	Pcs / Box	Mq / Box	Kg / Box	Mq / Pallet	Kg / Pallet	Box / Pallet
------	------	--------	------	------	-----------	----------	----------	-------------	-------------	--------------

DOLMIX

EFFETTO PIETRA - STONE EFFECT - EFFET PIERRE - STEIN EFFEKT

33x60x4 (13"x24") Scalino incollato - 9 mm - Rettificato

● Natural R9

FF3S	DOLMIX DARK		113,70	PZ	4	0,79	21,70	19,01	533,80	24
FF1S	DOLMIX GREY		113,70							
FF2S	DOLMIX LIGHT		113,70							

Lavorato su richiesta e venduto solo a scatole complete / Manufactured upon request and only full boxes sold / Seulement à la demande et vendus par boîte complete / Nur auf Anfrage und nur volle Karton

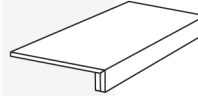

33x33x4 (13"x13") Scalino angolare incollato - 9 mm - Rettificato

● Natural R9

FFV3	DOLMIX DARK		138,80	PZ	4	0,44	14,48	13,07	447,40	30
FFV1	DOLMIX GREY		138,80							
FFV2	DOLMIX LIGHT		138,80							

Lavorato su richiesta e venduto solo a scatole complete / Manufactured upon request and only full boxes sold / Seulement à la demande et vendus par boîte complete / Nur auf Anfrage und nur volle Karton



4,6x120 (1.80"x48") Battiscopa - 9 mm - Rettificato

● Natural R9

FFR3	DOLMIX DARK		24,70	PZ	6	7,20	7,80	345,60	387,40	48
FFR1	DOLMIX GREY		24,70							
FFR2	DOLMIX LIGHT		24,70							

Mt

Venduti solo a scatole complete / Only full boxes sold / Vendus par boîte complete / Nur volle Karton

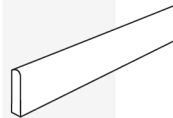

7,2x60 (2.80"x24") Battiscopa - 9 mm - Rettificato

● Natural R9

R3FF	DOLMIX DARK		11,70	PZ	10	6,00	10,48	480,00	851,40	80
R1FF	DOLMIX GREY		11,70							
R2FF	DOLMIX LIGHT		11,70							

Mt

Venduti solo a scatole complete / Only full boxes sold / Vendus par boîte complete / Nur volle Karton

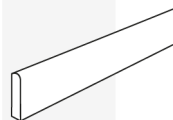

DOLMIX

Size	Code	Colour	Euro	U.M.	Pcs / Box	Mq / Box	Kg / Box	Mq / Pallet	Kg / Pallet	Box / Pallet
------	------	--------	------	------	--------------	-------------	-------------	----------------	----------------	-----------------

ELEMENTS DESIGN

EFFETTO RESINA - RESIN EFFECT - EFFET RÉSINE - HARZ EFFEKT

120x278 (48"x110") (119,5x278)* - 6 mm - Rettificato

● Natural R9

A006	ELEMENTS DESIGN WHITE	127,30	MQ	1	3,32	49,56	59,80	990,08	18
------	-----------------------	--------	----	---	------	-------	-------	--------	----



Addebito cassa leggera (max7pz) (prezzo netto) / Light crate charge (max7pz) (net price) / Débit de caisse (max7pz) (prix net) / Kasse belasten (max7pz) (Nettopreis) - € 100
 Addebito cassa (prezzo netto) / Crate charge (net price) / Palette supplémentaire (prix net) / Aufreispalette (Nettopreis) - € 160
 Addebito cavalletto 18pz (prezzo netto) / Extra rack 18pcs (net price) / Chevalet supplémentaire 18pcs (prix net) / Aufpreisgestell 18St (Nettopreis) - € 270
 Addebito cavalletto 42pz (prezzo netto) / Extra rack 42pcs (net price) / Chevalet supplémentaire 42pcs (prix net) / Aufpreisgestell 42St (Nettopreis) - € 270

120x120 (48"x48") (119,5x119,5)* - 9 mm - Rettificato

● Natural R9

53A0	ELEMENTS DESIGN BEIGE	98,20	MQ	2	2,86	60,80	57,12	1.251,00	20
57A0	ELEMENTS DESIGN BLACK	102,70							
55A0	ELEMENTS DESIGN GREY	98,20							
52A0	ELEMENTS DESIGN IVORY	98,20							
51A0	ELEMENTS DESIGN SILVER	102,70							
54A0	ELEMENTS DESIGN TAUPE	102,70							
56A0	ELEMENTS DESIGN WHITE	102,70							

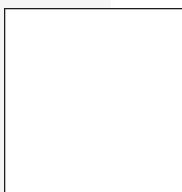

60x120 (24"x48") - 9 mm - Rettificato

● Natural R9

73A0	ELEMENTS DESIGN BEIGE	80,00	MQ	2	1,44	31,93	50,40	1.138,00	35
77A0	ELEMENTS DESIGN BLACK	83,10							
75A0	ELEMENTS DESIGN GREY	80,00							
72A0	ELEMENTS DESIGN IVORY	80,00							
71A0	ELEMENTS DESIGN SILVER	83,10							
74A0	ELEMENTS DESIGN TAUPE	83,10							
76A0	ELEMENTS DESIGN WHITE	83,10							

■ Structured R10

95A0	ELEMENTS DESIGN GREY	80,00							
91A0	ELEMENTS DESIGN SILVER	83,10							
86A0	ELEMENTS DESIGN WHITE	83,10							



ELEMENTS DESIGN

Size	Code	Colour	Euro	U.M.	Pcs / Box	Mq / Box	Kg / Box	Mq / Pallet	Kg / Pallet	Box / Pallet
------	------	--------	------	------	--------------	-------------	-------------	----------------	----------------	-----------------

ELEMENTS DESIGN

EFFETTO RESINA - RESIN EFFECT - EFFET RÉSINE - HARZ EFFEKT

60x60 (24"x24") - 9 mm - Rettificato

● Natural R9

03A0	ELEMENTS DESIGN BEIGE	59,10	MQ	3	1,08	21,00	43,20	853,00	40
06A0	ELEMENTS DESIGN BLACK	61,20							
01A1	ELEMENTS DESIGN GREY	59,10							
02A1	ELEMENTS DESIGN IVORY	59,10							
01A0	ELEMENTS DESIGN SILVER	61,20							
03A1	ELEMENTS DESIGN TAUPE	61,20							
05A0	ELEMENTS DESIGN WHITE	61,20							

■ Structured R10

11A0	ELEMENTS DESIGN GREY	59,10							
31A0	ELEMENTS DESIGN SILVER	61,20							
15A0	ELEMENTS DESIGN WHITE	61,20							

30x60 (12"x24") - 9 mm - Rettificato

● Natural R9

A03D	ELEMENTS DESIGN BEIGE	49,00	MQ	7	1,26	25,00	50,40	1.016,00	40
A07D	ELEMENTS DESIGN BLACK	50,70							
A05D	ELEMENTS DESIGN GREY	49,00							
A02D	ELEMENTS DESIGN IVORY	49,00							
A01D	ELEMENTS DESIGN SILVER	50,70							
A04D	ELEMENTS DESIGN TAUPE	50,70							
A06F	ELEMENTS DESIGN WHITE	50,70							

■ Structured R10

A05I	ELEMENTS DESIGN GREY	49,00							
A01I	ELEMENTS DESIGN SILVER	50,70							
A06Q	ELEMENTS DESIGN WHITE	50,70							

ELEMENTS DESIGN

Size	Code	Colour	Euro	U.M.	Pcs / Box	Mq / Box	Kg / Box	Mq / Pallet	Kg / Pallet	Box / Pallet
------	------	--------	------	------	-----------	----------	----------	-------------	-------------	--------------

ELEMENTS DESIGN

EFFETTO RESINA - RESIN EFFECT - EFFET RÉSINE - HARZ EFFEKT

9,7x60 (3.80"x24") - 9 mm - Rettificato

● Natural R9

A0L3	ELEMENTS DESIGN BEIGE	81,10	MQ	10	0,58	12,75	34,92	781,00	60
A0L7	ELEMENTS DESIGN BLACK	83,80							
A0L5	ELEMENTS DESIGN GREY	81,10							
L2A0	ELEMENTS DESIGN IVORY	81,10							
A0L1	ELEMENTS DESIGN SILVER	83,80							
A0L4	ELEMENTS DESIGN TAUPE	83,80							
A0L6	ELEMENTS DESIGN WHITE	83,80							

30x60 (12"x24") Decoro Docks - 9 mm - Rettificato

● Natural R9

3MA0	ELEMENTS DESIGN BEIGE	24,70	PZ	5	0,90	17,50	35,10	695,50	39
6M0A	ELEMENTS DESIGN BLACK	24,70							
1MA0	ELEMENTS DESIGN GREY	24,70							
2MA0	ELEMENTS DESIGN IVORY	24,70							
0MA0	ELEMENTS DESIGN SILVER	24,70							
4MA0	ELEMENTS DESIGN TAUPE	24,70							
5MA0	ELEMENTS DESIGN WHITE	24,70							

Venduti solo a scatole complete / Only full boxes sold /
Vendus par boite complete / Nur volle Karton

10x59 Chevron Dx - 9 mm - Rettificato

● Natural R9

A0T3	ELEMENTS DESIGN BEIGE	11,50	PZ	16	0,78	14,72	37,63	719,56	48
A0T7	ELEMENTS DESIGN BLACK	11,50							
A0T5	ELEMENTS DESIGN GREY	11,50							
A0T2	ELEMENTS DESIGN IVORY	11,50							
A0T1	ELEMENTS DESIGN SILVER	11,50							
A0T4	ELEMENTS DESIGN TAUPE	11,50							
A0T6	ELEMENTS DESIGN WHITE	11,50							

Venduti solo a scatole complete / Only full boxes sold /
Vendus par boite complete / Nur volle Karton

ELEMENTS DESIGN

Size	Code	Colour	Euro	U.M.	Pcs / Box	Mq / Box	Kg / Box	Mq / Pallet	Kg / Pallet	Box / Pallet
------	------	--------	------	------	-----------	----------	----------	-------------	-------------	--------------

ELEMENTS DESIGN

EFFETTO RESINA - RESIN EFFECT - EFFET RÉSINE - HARZ EFFEKT

10x59 Chevron Sx - 9 mm - Rettificato

● Natural R9

T3A0	ELEMENTS DESIGN BEIGE	11,50	PZ	16	0,78	14,72	37,63	719,56	48
T7A0	ELEMENTS DESIGN BLACK	11,50							
T5A0	ELEMENTS DESIGN GREY	11,50							
T2A0	ELEMENTS DESIGN IVORY	11,50							
T1A0	ELEMENTS DESIGN SILVER	11,50							
T4A0	ELEMENTS DESIGN TAUPE	11,50							
T6A0	ELEMENTS DESIGN WHITE	11,50							

Venduti solo a scatole complete / Only full boxes sold /
Vendus par boîte complete / Nur volle Karton



34,5x42 Mosaico Herringbone (4,5x29,5) - 9 mm - Rettificato

● Natural R9

M3A0	ELEMENTS DESIGN BEIGE	37,90	PZ	4	0,56	11,48	11,20	242,60	20
M7A0	ELEMENTS DESIGN BLACK	37,90							
M5A0	ELEMENTS DESIGN GREY	37,90							
A2A0	ELEMENTS DESIGN IVORY	37,90							
M1A0	ELEMENTS DESIGN SILVER	37,90							
M4A0	ELEMENTS DESIGN TAUPE	37,90							
M6A0	ELEMENTS DESIGN WHITE	37,90							

Venduti solo a scatole complete / Only full boxes sold /
Vendus par boîte complete / Nur volle Karton



35,2x30 Mosaico Rombi (10x10) - 9 mm - Rettificato

● Natural R9

A0CL	E. DESIGN COLD (BLACK / GREY / SILVER)	25,00	PZ	4	0,42	8,36	20,16	414,28	48
A0WM	E. DESIGN WARM (BEIGE / GREY / IVORY)	25,00							

Venduti solo a scatole complete / Only full boxes sold /
Vendus par boîte complete / Nur volle Karton



ELEMENTS DESIGN

Size	Code	Colour	Euro	U.M.	Pcs / Box	Mq / Box	Kg / Box	Mq / Pallet	Kg / Pallet	Box / Pallet
------	------	--------	------	------	-----------	----------	----------	-------------	-------------	--------------

ELEMENTS DESIGN

EFFETTO RESINA - RESIN EFFECT - EFFET RÉSINE - HARZ EFFEKT

30x30 (12"x12") Mosaico T100 (2,8x2,8) - 9 mm - Rettificato

● Natural R9

A0M3	ELEMENTS DESIGN BEIGE	27,80	PZ	6	0,54	11,20	25,00	550,60	48
A0M7	ELEMENTS DESIGN BLACK	27,80							
A0M5	ELEMENTS DESIGN GREY	27,80							
A0M2	ELEMENTS DESIGN IVORY	27,80							
A0M1	ELEMENTS DESIGN SILVER	27,80							
A0M4	ELEMENTS DESIGN TAUPE	27,80							
A0M6	ELEMENTS DESIGN WHITE	27,80							

Venduti solo a scatole complete / Only full boxes sold /
Vendus par boîte complete / Nur volle Karton

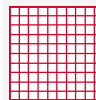

999x999 Lavello a colonna - 6 mm - Non rettificato

● Natural R9

Z6A0	ELEMENTS DESIGN WHITE	1474,80	PZ	1	1,74			0,00	1
------	-----------------------	---------	----	---	------	--	--	------	---

33x120x4 (13"x48") Scalino incollato - 9 mm - Rettificato

● Natural R9

J3A0	ELEMENTS DESIGN BEIGE	235,10	PZ	2	0,79	18,40	19,01	454,60	24
J7A0	ELEMENTS DESIGN BLACK	235,10							
J5A0	ELEMENTS DESIGN GREY	235,10							
J2A0	ELEMENTS DESIGN IVORY	235,10							
J1A0	ELEMENTS DESIGN SILVER	235,10							
J4A0	ELEMENTS DESIGN TAUPE	235,10							
J6A0	ELEMENTS DESIGN WHITE	235,10							

Lavorato su richiesta e venduto solo a scatole complete / Manufactured upon request
and only full boxes sold / Seulement à la demande et vendus par boîte complete / Nur
auf Anfrage und nur volle Karton

■ Structured R10

A0J3	ELEMENTS DESIGN BEIGE	235,10							
A0J7	ELEMENTS DESIGN BLACK	235,10							
A0J5	ELEMENTS DESIGN GREY	235,10							
A0J2	ELEMENTS DESIGN IVORY	235,10							
A0J1	ELEMENTS DESIGN SILVER	235,10							
A0J4	ELEMENTS DESIGN TAUPE	235,10							
A0J6	ELEMENTS DESIGN WHITE	235,10							

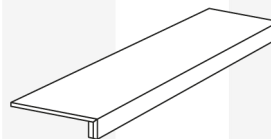

ELEMENTS DESIGN

Size	Code	Colour	Euro	U.M.	Pcs / Box	Mq / Box	Kg / Box	Mq / Pallet	Kg / Pallet	Box / Pallet
------	------	--------	------	------	--------------	-------------	-------------	----------------	----------------	-----------------

ELEMENTS DESIGN

EFFETTO RESINA - RESIN EFFECT - EFFET RÉSINE - HARZ EFFEKT

33x120x4 (13"x48") Scalino angolare incollato - 9 mm - Rettificato

● Natural R9

Q2A0	ELEMENTS DESIGN IVORY ANG. SX	258,50	PZ	1	0,40	9,00	9,50	238,60	24
K3A0	ELEMENTS DESIGN BEIGE ANG. DX	258,50							
Q3A0	ELEMENTS DESIGN BEIGE ANG. SX	258,50							
K7A0	ELEMENTS DESIGN BLACK ANG. DX	258,50							
Q7A0	ELEMENTS DESIGN BLACK ANG. SX	258,50							
K5A0	ELEMENTS DESIGN GREY ANG. DX	258,50							
Q5A0	ELEMENTS DESIGN GREY ANG. SX	258,50							
K2A0	ELEMENTS DESIGN IVORY ANG. DX	258,50							
K1A0	ELEMENTS DESIGN SILVER ANG. DX	258,50							
Q1A0	ELEMENTS DESIGN SILVER ANG. SX	258,50							
K4A0	ELEMENTS DESIGN TAUPE ANG. DX	258,50							
Q4A0	ELEMENTS DESIGN TAUPE ANG. SX	258,50							
K6A0	ELEMENTS DESIGN WHITE ANG. DX	258,50							
Q6A0	ELEMENTS DESIGN WHITE ANG. SX	258,50							

Lavorato su richiesta e venduto solo a scatole complete / Manufactured upon request and only full boxes sold / Seulement à la demande et vendus par boîte complete / Nur auf Anfrage und nur volle Karton

ELEMENTS DESIGN

■ Structured R10

A0K3	ELEMENTS DESIGN BEIGE ANG. DX	258,50							
A0Q3	ELEMENTS DESIGN BEIGE ANG. SX	258,50							
A0K7	ELEMENTS DESIGN BLACK ANG. DX	258,50							
A0Q7	ELEMENTS DESIGN BLACK ANG. SX	258,50							
A0K5	ELEMENTS DESIGN GREY ANG. DX	258,50							
A0Q5	ELEMENTS DESIGN GREY ANG. SX	258,50							
A0K2	ELEMENTS DESIGN IVORY ANG. DX	258,50							
A0Q2	ELEMENTS DESIGN IVORY ANG. SX	258,50							
A0K1	ELEMENTS DESIGN SILVER ANG. DX	258,50							
A0Q1	ELEMENTS DESIGN SILVER ANG. SX	258,50							
A0K4	ELEMENTS DESIGN TAUPE ANG. DX	258,50							
A0Q4	ELEMENTS DESIGN TAUPE ANG. SX	258,50							
A0K6	ELEMENTS DESIGN WHITE ANG. DX	258,50							
A0Q6	ELEMENTS DESIGN WHITE ANG. SX	258,50							

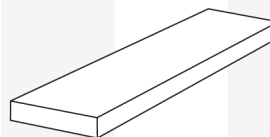

Size	Code	Colour	Euro	U.M.	Pcs / Box	Mq / Box	Kg / Box	Mq / Pallet	Kg / Pallet	Box / Pallet
------	------	--------	------	------	-----------	----------	----------	-------------	-------------	--------------

ELEMENTS DESIGN

EFFETTO RESINA - RESIN EFFECT - EFFET RÉSINE - HARZ EFFEKT

33x60x4 (13"x24") Scalino incollato - 9 mm - Rettificato

● Natural R9

A0S3	ELEMENTS DESIGN BEIGE	113,70	PZ	4	0,79	21,70	19,01	533,80	24
A0S7	ELEMENTS DESIGN BLACK	113,70							
A0S5	ELEMENTS DESIGN GREY	113,70							
A0S2	ELEMENTS DESIGN IVORY	113,70							
A0S1	ELEMENTS DESIGN SILVER	113,70							
A0S4	ELEMENTS DESIGN TAUPE	113,70							
A0S6	ELEMENTS DESIGN WHITE	113,70							

Lavorato su richiesta e venduto solo a scatole complete / Manufactured upon request and only full boxes sold / Seulement à la demande et vendus par boîte complete / Nur auf Anfrage und nur volle Karton

■ Structured R10

A03S	ELEMENTS DESIGN BEIGE	113,70							
7SA0	ELEMENTS DESIGN BLACK	113,70							
5SA0	ELEMENTS DESIGN GREY	113,70							
2SA0	ELEMENTS DESIGN IVORY	113,70							
A01S	ELEMENTS DESIGN SILVER	113,70							
A04S	ELEMENTS DESIGN TAUPE	113,70							
6SA0	ELEMENTS DESIGN WHITE	113,70							

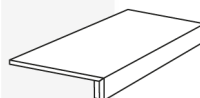

ELEMENTS DESIGN

33x33x4 (13"x13") Scalino angolare incollato - 9 mm - Rettificato

● Natural R9

A0A3	ELEMENTS DESIGN BEIGE	138,80	PZ	4	0,44	14,48	13,07	447,40	30
A0A7	ELEMENTS DESIGN BLACK	138,80							
A0A5	ELEMENTS DESIGN GREY	138,80							
A0A2	ELEMENTS DESIGN IVORY	138,80							
A0A1	ELEMENTS DESIGN SILVER	138,80							
A0A4	ELEMENTS DESIGN TAUPE	138,80							
A0A6	ELEMENTS DESIGN WHITE	138,80							

Lavorato su richiesta e venduto solo a scatole complete / Manufactured upon request and only full boxes sold / Seulement à la demande et vendus par boîte complete / Nur auf Anfrage und nur volle Karton

■ Structured R10

3AA0	ELEMENTS DESIGN BEIGE	138,80							
7AA0	ELEMENTS DESIGN BLACK	138,80							
5AA0	ELEMENTS DESIGN GREY	138,80							
2AA0	ELEMENTS DESIGN IVORY	138,80							
1AA0	ELEMENTS DESIGN SILVER	138,80							
4AA0	ELEMENTS DESIGN TAUPE	138,80							
6AA0	ELEMENTS DESIGN WHITE	138,80							



Size	Code	Colour	Euro	U.M.	Pcs / Box	Mq / Box	Kg / Box	Mq / Pallet	Kg / Pallet	Box / Pallet
------	------	--------	------	------	--------------	-------------	-------------	----------------	----------------	-----------------

ELEMENTS DESIGN

EFFETTO RESINA - RESIN EFFECT - EFFET RÉSINE - HARZ EFFEKT

7,2x60 (2.80"x24") Battiscopa - 9 mm - Rettificato

● Natural R9

					Mt				
A0X3	ELEMENTS DESIGN BEIGE	11,70	PZ	10	6,00	10,48	480,00	851,40	80
A0X7	ELEMENTS DESIGN BLACK	11,70							
A0X5	ELEMENTS DESIGN GREY	11,70							
A0X2	ELEMENTS DESIGN IVORY	11,70							
A0X1	ELEMENTS DESIGN SILVER	11,70							
A0X4	ELEMENTS DESIGN TAUPE	11,70							
A0X6	ELEMENTS DESIGN WHITE	11,70							

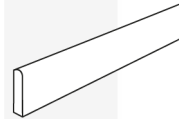

Venduti solo a scatole complete / Only full boxes sold /
Vendus par boîte complete / Nur volle Karton

ELEMENTS DESIGN

Size	Code	Colour	Euro	U.M.	Pcs / Box	Mq / Box	Kg / Box	Mq / Pallet	Kg / Pallet	Box / Pallet
------	------	--------	------	------	--------------	-------------	-------------	----------------	----------------	-----------------

ELEMENTS LUX

EFFETTO MARMO - MARBLE EFFECT - EFFET MARBRE - MARMOR EFFEKT

120x278 (48"x110") (119,5x119,5)* - 6 mm - Rettificato

◆ Lappato

N9A2	E. LUX CALACATTA STATUARIETTO	166,20	MQ	1	3,32	49,56	59,80	990,08	18
A2N1	ELEMENTS LUX CALACATTA	166,20							
A2N8	ELEMENTS LUX CALACATTA GOLD	166,20							
A2N4	ELEMENTS LUX EMPERADOR	166,20							
A2N5	ELEMENTS LUX PORT LAURENT	166,20							
A2N2	ELEMENTS LUX SILVER GREY	160,40							

✕ Silky

K8A2	ELEMENTS LUX CALACATTA GOLD	144,50							
ECN2	ELEMENTS LUX PERSIAN GREY	138,10							
2NA2	ELEMENTS LUX SILVER GREY	139,40							

Addebito cassa leggera (max7pz) (prezzo netto) / Light crate charge (max7pz) (net price) / Débit de caisse (max7pz) (prix net) / Kasse belasten (max7pz) (Nettopreis) - € 100
 Addebito cassa (prezzo netto) / Crate charge (net price) / Palette supplémentaire (prix net) / Aufpreispalette (Nettopreis) - € 160
 Addebito cavalletto 18pz (prezzo netto) / Extra rack 18pcs (net price) / Chevalet supplémentaire 18pcs (prix net) / Aufpreisgestell 18St (Nettopreis) - € 270
 Addebito cavalletto 42pz (prezzo netto) / Extra rack 42pcs (net price) / Chevalet supplémentaire 42pcs (prix net) / Aufpreisgestell 42St (Nettopreis) - € 270

120x120 (48"x48") (119,5x119,5)* - 9 mm - Rettificato

◆ Lappato

59A2	E. LUX CALACATTA STATUARIETTO	142,20	MQ	2	2,86	60,80	57,12	1.251,00	20
2A51	ELEMENTS LUX CALACATTA	142,20							
2A58	ELEMENTS LUX CALACATTA GOLD	142,20							
2A56	ELEMENTS LUX LINCOLN	136,70							
2A52	ELEMENTS LUX SILVER GREY	136,70							

✕ Silky

K5A2	ELEMENTS LUX CALACATTA GOLD	122,60							
ECB2	ELEMENTS LUX PERSIAN GREY	113,20							
SKA2	ELEMENTS LUX SILVER GREY	117,60							

ELEMENTS LUX

Size	Code	Colour	Euro	U.M.	Pcs / Box	Mq / Box	Kg / Box	Mq / Pallet	Kg / Pallet	Box / Pallet
------	------	--------	------	------	--------------	-------------	-------------	----------------	----------------	-----------------

ELEMENTS LUX

EFFETTO MARMO - MARBLE EFFECT - EFFET MARBRE - MARMOR EFFEKT

60x120 (24"x48") - 9 mm - Rettificato

◆ Lappato

2A31	ELEMENTS LUX CALACATTA	112,00	MQ	2	1,44	31,93	50,40	1.138,00	35
2A28	ELEMENTS LUX CALACATTA GOLD	112,00							
2A39	ELEMENTS LUX CALACATTA STATUARIETTO	112,00							
2A24	ELEMENTS LUX EMPERADOR	112,00							
2A26	ELEMENTS LUX LINCOLN	106,20							
2A25	ELEMENTS LUX PORT LAURENT	112,00							
2A22	ELEMENTS LUX SILVER GREY	106,20							

✕ Silky

K22A	ELEMENTS LUX CALACATTA GOLD	90,80							
ECC2	ELEMENTS LUX PERSIAN GREY	85,10							
2ASK	ELEMENTS LUX SILVER GREY	86,10							

● Natural R9

21A2	ELEMENTS LUX CALACATTA	85,60							
28A2	ELEMENTS LUX CALACATTA GOLD	85,60							
292A	ELEMENTS LUX CALACATTA STATUARIETTO	85,60							
24A2	ELEMENTS LUX EMPERADOR	85,60							
26A2	ELEMENTS LUX LINCOLN	81,00							
25A2	ELEMENTS LUX PORT LAURENT	85,60							
22A2	ELEMENTS LUX SILVER GREY	81,00							



ELEMENTS LUX

Size	Code	Colour	Euro	U.M.	Pcs / Box	Mq / Box	Kg / Box	Mq / Pallet	Kg / Pallet	Box / Pallet
------	------	--------	------	------	--------------	-------------	-------------	----------------	----------------	-----------------

ELEMENTS LUX

EFFETTO MARMO - MARBLE EFFECT - EFFET MARBRE - MARMOR EFFEKT

60x60 (24"x24") - 9 mm - Rettificato

◆ Lappato

2A61	ELEMENTS LUX CALACATTA	105,50	MQ	3	1,08	21,00	43,20	853,00	40
2A68	ELEMENTS LUX CALACATTA GOLD	105,50							
O92A	ELEMENTS LUX CALACATTA STATUARIETTO	105,50							
2A64	ELEMENTS LUX EMPERADOR	105,50							
2A66	ELEMENTS LUX LINCOLN	98,10							
2A65	ELEMENTS LUX PORT LAURENT	105,50							
2A62	ELEMENTS LUX SILVER GREY	98,10							

✕ Silky

K6A2	ELEMENTS LUX CALACATTA GOLD	70,10							
ECE3	ELEMENTS LUX PERSIAN GREY	64,00							
KSA2	ELEMENTS LUX SILVER GREY	64,90							

● Natural R9

A201	ELEMENTS LUX CALACATTA	67,30							
A208	ELEMENTS LUX CALACATTA GOLD	67,30							
90A2	ELEMENTS LUX CALACATTA STATUARIETTO	67,30							
A204	ELEMENTS LUX EMPERADOR	67,30							
A205	ELEMENTS LUX LINCOLN	62,50							
A207	ELEMENTS LUX PORT LAURENT	67,30							
A202	ELEMENTS LUX SILVER GREY	62,50							

10x59 Chevron Dx - 9 mm - Rettificato

◆ Lappato

A2T1	ELEMENTS LUX CALACATTA	15,30	PZ	16	0,78	14,72	37,63	719,56	48
A2T8	ELEMENTS LUX CALACATTA GOLD	15,30							
9TA2	ELEMENTS LUX CALACATTA STATUARIETTO	15,30							
A2T4	ELEMENTS LUX EMPERADOR	15,30							
A2T6	ELEMENTS LUX LINCOLN	15,30							
A2T5	ELEMENTS LUX PORT LAURENT	15,30							
A2T2	ELEMENTS LUX SILVER GREY	15,30							

Venduti solo a scatole complete / Only full boxes sold /
Vendus par boîte complete / Nur volle Karton

ELEMENTS LUX

Size	Code	Colour	Euro	U.M.	Pcs / Box	Mq / Box	Kg / Box	Mq / Pallet	Kg / Pallet	Box / Pallet
------	------	--------	------	------	-----------	----------	----------	-------------	-------------	--------------

ELEMENTS LUX

EFFETTO MARMO - MARBLE EFFECT - EFFET MARBRE - MARMOR EFFEKT

10x59 Chevron Sx - 9 mm - Rettificato

◆ Lappato

T1A2	ELEMENTS LUX CALACATTA	15,30	PZ	16	0,78	14,72	37,63	719,56	48
T8A2	ELEMENTS LUX CALACATTA GOLD	15,30							
T9A2	ELEMENTS LUX CALACATTA STATUARIETTO	15,30							
T4A2	ELEMENTS LUX EMPERADOR	15,30							
T6A2	ELEMENTS LUX LINCOLN	15,30							
T5A2	ELEMENTS LUX PORT LAURENT	15,30							
C2A2	ELEMENTS LUX SILVER GREY	15,30							



35,2x30 Mosaico Rombi (10x10) - 9 mm - Rettificato

◆ Lappato

A2MR	E.LUX (PORT LAURENT / SILVER GREY / LINCOLN)	39,20	PZ	4	0,42	8,36	20,16	414,28	48
------	--	-------	----	---	------	------	-------	--------	----

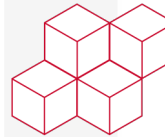

30x30 (12"x12") Mosaico T100 (2,8x2,8) - 9 mm - Rettificato

◆ Lappato

A2M1	ELEMENTS LUX CALACATTA	32,90	PZ	6	0,54	11,20	25,00	550,60	48
A2M8	ELEMENTS LUX CALACATTA GOLD	32,90							
M9A2	ELEMENTS LUX CALACATTA STATUARIETTO	32,90							
A2M4	ELEMENTS LUX EMPERADOR	32,90							
A2M6	ELEMENTS LUX LINCOLN	32,90							
A2M5	ELEMENTS LUX PORT LAURENT	32,90							
A2M2	ELEMENTS LUX SILVER GREY	32,90							

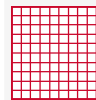

✕ Silky

ECA2	ELEMENTS LUX PERSIAN GREY	30,50							
------	---------------------------	-------	--	--	--	--	--	--	--

30x60 (12"x24") Decoro Next - 12 mm - Rettificato

✕ Silky

ECM2	ELEMENTS LUX PERSIAN GREY	117,30	MQ	5	0,90	23,50	36,00	953,00	40
------	---------------------------	--------	----	---	------	-------	-------	--------	----



ELEMENTS LUX

Size	Code	Colour	Euro	U.M.	Pcs / Box	Mq / Box	Kg / Box	Mq / Pallet	Kg / Pallet	Box / Pallet
------	------	--------	------	------	--------------	-------------	-------------	----------------	----------------	-----------------

ELEMENTS LUX

EFFETTO MARMO - MARBLE EFFECT - EFFET MARBRE - MARMOR EFFEKT

33x120x4 (13"x48") Scalino incollato - 9 mm - Rettificato

◆ Lappato

A2B1	ELEMENTS LUX CALACATTA	268,50	PZ	2	0,79	18,40	19,01	454,60	24
A2B8	ELEMENTS LUX CALACATTA GOLD	268,50							
B92A	ELEMENTS LUX CALACATTA STATUARIETTO	268,50							
A2B4	ELEMENTS LUX EMPERADOR	268,50							
A2B6	ELEMENTS LUX LINCOLN	268,50							
A2B5	ELEMENTS LUX PORT LAURENT	268,50							
A2B2	ELEMENTS LUX SILVER GREY	268,50							

Lavorato su richiesta e venduto solo a scatole complete / Manufactured upon request and only full boxes sold / Seulement à la demande et vendus par boîte complete / Nur auf Anfrage und nur volle Karton

✕ Silky

KBA2	ELEMENTS LUX CALACATTA GOLD	243,50							
ECS2	ELEMENTS LUX PERSIAN GREY	243,50							
2AKB	ELEMENTS LUX SILVER GREY	243,50							

● Natural R9

A2C1	ELEMENTS LUX CALACATTA	235,10							
A2C8	ELEMENTS LUX CALACATTA GOLD	235,10							
C9A2	ELEMENTS LUX CALACATTA STATUARIETTO	235,10							
A2C4	ELEMENTS LUX EMPERADOR	235,10							
A2C6	ELEMENTS LUX LINCOLN	235,10							
A2C5	ELEMENTS LUX PORT LAURENT	235,10							
A2C2	ELEMENTS LUX SILVER GREY	235,10							

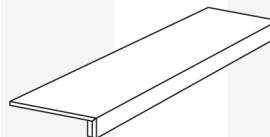

Size	Code	Colour	Euro	U.M.	Pcs / Box	Mq / Box	Kg / Box	Mq / Pallet	Kg / Pallet	Box / Pallet
------	------	--------	------	------	--------------	-------------	-------------	----------------	----------------	-----------------

ELEMENTS LUX

EFFETTO MARMO - MARBLE EFFECT - EFFET MARBRE - MARMOR EFFEKT

33x120x4 (13"x48") Scalino angolare incollato - 9 mm - Rettificato

◆ Lappato

A2F1	E. LUX CALACATTA ANG. DX	295,30	PZ	1	0,40	9,00	9,50	238,60	24
A2G1	E. LUX CALACATTA ANG. SX	295,30							
A2F8	E. LUX CALACATTA GOLD ANG. DX	295,30							
A2G8	E. LUX CALACATTA GOLD ANG. SX	295,30							
A2F4	E. LUX EMPERADOR ANG. DX	295,30							
A2G4	E. LUX EMPERADOR ANG. SX	295,30							
A2F6	E. LUX LINCOLN ANG. DX	295,30							
A2H6	E. LUX LINCOLN ANG. SX	295,30							
A2F5	E. LUX PORT LAURENT ANG. DX	295,30							
A2H5	E. LUX PORT LAURENT ANG. SX	295,30							
A2F2	E. LUX SILVER GREY ANG. DX	295,30							
A2H2	E. LUX SILVER GREY ANG. SX	295,30							
F92A	E. LUX STATUARIETTO ANG. DX	295,30							
I9A2	E. LUX STATUARIETTO ANG. SX	295,30							

Lavorato su richiesta e venduto solo a scatole complete / Manufactured upon request and only full boxes sold / Seulement à la demande et vendus par boîte complete / Nur auf Anfrage und nur volle Karton

ELEMENTS LUX

× Silky

FKA2	E. LUX CALACATTA GOLD ANG. DX	267,60							
GKA2	E. LUX CALACATTA GOLD ANG. SX	267,60							
ECT2	E. LUX PERSIAN GREY ANG. DX	267,60							
ECU2	E. LUX PERSIAN GREY ANG. SX	267,60							
FK2A	E. LUX SILVER GREY ANG. DX	267,60							
2AGK	E. LUX SILVER GREY ANG. SX	267,60							

● Natural R9

A2I1	E. LUX CALACATTA ANG. DX	258,50							
A2P1	E. LUX CALACATTA ANG. SX	258,50							
A2I8	E. LUX CALACATTA GOLD ANG. DX	258,50							
A2P8	E. LUX CALACATTA GOLD ANG. SX	258,50							
A2I4	E. LUX EMPERADOR ANG. DX	258,50							
A2P4	E. LUX EMPERADOR ANG. SX	258,50							
A2I6	E. LUX LINCOLN ANG. DX	258,50							
A2P6	E. LUX LINCOLN ANG. SX	258,50							
A2I5	E. LUX PORT LAURENT ANG. DX	258,50							
A2P5	E. LUX PORT LAURENT ANG. SX	258,50							
A2I2	E. LUX SILVER GREY ANG. DX	258,50							
A2P2	E. LUX SILVER GREY ANG. SX	258,50							
P9A2	E. LUX STATUARIETTO ANG. DX	258,50							
G9A2	E. LUX STATUARIETTO ANG. SX	258,50							

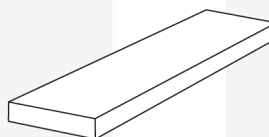

Size	Code	Colour	Euro	U.M.	Pcs / Box	Mq / Box	Kg / Box	Mq / Pallet	Kg / Pallet	Box / Pallet
------	------	--------	------	------	--------------	-------------	-------------	----------------	----------------	-----------------

ELEMENTS LUX

EFFETTO MARMO - MARBLE EFFECT - EFFET MARBRE - MARMOR EFFEKT

33x60x4 (13"x24") Scalino incollato - 9 mm - Rettificato

◆ Lappato

L1A2	ELEMENTS LUX CALACATTA	129,40	PZ	4	0,79	21,70	19,01	533,80	24
L8A2	ELEMENTS LUX CALACATTA GOLD	129,40							
L9A2	ELEMENTS LUX CALACATTA STATUARIETTO	129,40							
L4A2	ELEMENTS LUX EMPERADOR	129,40							
L6A2	ELEMENTS LUX LINCOLN	129,40							
L5A2	ELEMENTS LUX PORT LAURENT	129,40							
L3A2	ELEMENTS LUX SILVER GREY	129,40							

Lavorato su richiesta e venduto solo a scatole complete / Manufactured upon request and only full boxes sold / Seulement à la demande et vendus par boîte complete / Nur auf Anfrage und nur volle Karton

✕ Silky

NKA8	ELEMENTS LUX CALACATTA GOLD	121,10							
ECV2	ELEMENTS LUX PERSIAN GREY	121,10							
NKA2	ELEMENTS LUX SILVER GREY	121,10							

● Natural R9

N1A2	ELEMENTS LUX CALACATTA	113,70							
N8A2	ELEMENTS LUX CALACATTA GOLD	113,70							
N92A	ELEMENTS LUX CALACATTA STATUARIETTO	113,70							
N4A2	ELEMENTS LUX EMPERADOR	113,70							
N6A2	ELEMENTS LUX LINCOLN	113,70							
N5A2	ELEMENTS LUX PORT LAURENT	113,70							
N3A2	ELEMENTS LUX SILVER GREY	113,70							

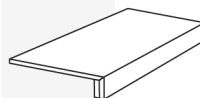

Size	Code	Colour	Euro	U.M.	Pcs / Box	Mq / Box	Kg / Box	Mq / Pallet	Kg / Pallet	Box / Pallet
------	------	--------	------	------	--------------	-------------	-------------	----------------	----------------	-----------------

ELEMENTS LUX

EFFETTO MARMO - MARBLE EFFECT - EFFET MARBRE - MARMOR EFFEKT

33x33x4 (13"x13") Scalino angolare incollato - 9 mm - Rettificato

◆ Lappato

1AA2	ELEMENTS LUX CALACATTA	158,00	PZ	4	0,44	14,48	13,07	447,40	30
A8A2	ELEMENTS LUX CALACATTA GOLD	158,00							
2A9A	ELEMENTS LUX CALACATTA STATUARIETTO	158,00							
A4A2	ELEMENTS LUX EMPERADOR	158,00							
A6A2	ELEMENTS LUX LINCOLN	158,00							
A5A2	ELEMENTS LUX PORT LAURENT	158,00							
A3A2	ELEMENTS LUX SILVER GREY	158,00							

Lavorato su richiesta e venduto solo a scatole complete / Manufactured upon request and only full boxes sold / Seulement à la demande et vendus par boîte complete / Nur auf Anfrage und nur volle Karton

✕ Silky

VKA2	ELEMENTS LUX CALACATTA GOLD	148,00							
ECZ2	ELEMENTS LUX PERSIAN GREY	148,00							
VK2A	ELEMENTS LUX SILVER GREY	148,00							

● Natural R9

V1A2	ELEMENTS LUX CALACATTA	138,80							
V8A2	ELEMENTS LUX CALACATTA GOLD	138,80							
V9A2	ELEMENTS LUX CALACATTA STATUARIETTO	138,80							
V4A2	ELEMENTS LUX EMPERADOR	138,80							
V6A2	ELEMENTS LUX LINCOLN	138,80							
V5A2	ELEMENTS LUX PORT LAURENT	138,80							
V3A2	ELEMENTS LUX SILVER GREY	138,80							



ELEMENTS LUX

Size	Code	Colour	Euro	U.M.	Pcs / Box	Mq / Box	Kg / Box	Mq / Pallet	Kg / Pallet	Box / Pallet
------	------	--------	------	------	--------------	-------------	-------------	----------------	----------------	-----------------

ELEMENTS LUX

EFFETTO MARMO - MARBLE EFFECT - EFFET MARBRE - MARMOR EFFEKT

4,6x120 (1.80"x48") Battiscopa - 9 mm - Rettificato

◆ Lappato

					Mt				
X9A2	ELEMENTS LUX CALACATTA STATUARIETTO	34,20	PZ	6	7,20	7,80	345,60	387,40	48
4XA2	ELEMENTS LUX EMPERADOR	34,20							
X6A2	ELEMENTS LUX LINCOLN	34,20							
X5A2	ELEMENTS LUX PORT LAURENT	34,20							
X22A	ELEMENTS LUX SILVER GREY	34,20							

Venduti solo a scatole complete / Only full boxes sold /
Vendus par boîte complete / Nur volle Karton

✕ Silky

KRA2	ELEMENTS LUX CALACATTA GOLD	26,40							
KR2A	ELEMENTS LUX SILVER GREY	26,40							

● Natural R9

1BA2	ELEMENTS LUX CALACATTA	24,70							
B82A	ELEMENTS LUX CALACATTA GOLD	24,70							
B9A2	ELEMENTS LUX CALACATTA STATUARIETTO	24,70							
4BA2	ELEMENTS LUX EMPERADOR	24,70							
6BA2	ELEMENTS LUX LINCOLN	24,70							
5B2A	ELEMENTS LUX PORT LAURENT	24,70							
B2A2	ELEMENTS LUX SILVER GREY	24,70							



ELEMENTS LUX

Size	Code	Colour	Euro	U.M.	Pcs / Box	Mq / Box	Kg / Box	Mq / Pallet	Kg / Pallet	Box / Pallet
------	------	--------	------	------	--------------	-------------	-------------	----------------	----------------	-----------------

ELEMENTS LUX

EFFETTO MARMO - MARBLE EFFECT - EFFET MARBRE - MARMOR EFFEKT

7,2x60 (2.80"x24") Battiscopa - 9 mm - Rettificato

◆ Lappato

				Mt						
A2X1	ELEMENTS LUX CALACATTA	16,30	PZ	10	6,00	10,48	480,00	851,40	80	
B2R8	ELEMENTS LUX CALACATTA GOLD	16,30		Venduti solo a scatole complete / Only full boxes sold / Vendus par boîte complete / Nur volle Karton						
2AX9	ELEMENTS LUX CALACATTA STATUARIETTO	16,30								
A2X4	ELEMENTS LUX EMPERADOR	16,30								
B2R6	ELEMENTS LUX LINCOLN	16,30								
A2X5	ELEMENTS LUX PORT LAURENT	16,30								
A2X2	ELEMENTS LUX SILVER GREY	16,30								

✕ Silky

K2R8	ELEMENTS LUX CALACATTA GOLD	12,60							
ECR2	ELEMENTS LUX PERSIAN GREY	12,60							

● Natural R9

BA21	ELEMENTS LUX CALACATTA	11,70							
B8A2	ELEMENTS LUX CALACATTA GOLD	11,70							
X92A	ELEMENTS LUX CALACATTA STATUARIETTO	11,70							
B4A2	ELEMENTS LUX EMPERADOR	11,70							
B6A2	ELEMENTS LUX LINCOLN	11,70							
5BA2	ELEMENTS LUX PORT LAURENT	11,70							
B22A	ELEMENTS LUX SILVER GREY	11,70							
K22R	ELEMENTS LUX SILVER GREY	12,60							



ELEMENTS LUX

Size	Code	Colour	Euro	U.M.	Pcs / Box	Mq / Box	Kg / Box	Mq / Pallet	Kg / Pallet	Box / Pallet
------	------	--------	------	------	-----------	----------	----------	-------------	-------------	--------------

EVOKE

EFFETTO LEGNO - WOOD EFFECT - EFFET BOIS - HOLZ EFFEKT

20x120 (8"x48") - 9 mm - Rettificato

● Natural R9

Q741	EVOKE BEIGE		73,90	MQ	6	1,44	29,00	60,48	1.231,00	42
42Q7	EVOKE BROWN		73,90							
Q744	EVOKE SAND		73,90							

▲ Structured R11

41Q7	EVOKE BEIGE		75,20							
------	-------------	--	-------	--	--	--	--	--	--	--

6x120 (2.40"x48") - 9 mm - Rettificato

● Natural R9

Q701	EVOKE BEIGE		15,50	PZ	10	0,72	18,40	0,00	0,00	0
Q702	EVOKE BROWN		15,50							
Q704	EVOKE SAND		15,50							

3x120 (1.18"x48") - 9 mm - Rettificato

● Natural R9

Q7o1	EVOKE BEIGE		10,30	PZ	10	0,36	9,40	0,00	0,00	0
Q7o2	EVOKE BROWN		10,30							
Q7o4	EVOKE SAND		10,30							

30x120 (12"x48") - 20 mm - Rettificato

▲ Structured R11

Q7W2	EVOKE BROWN		137,00	MQ	2	0,72	33,05	25,92	1.203,00	36
Q7W4	EVOKE SAND		137,00							

7,2x60 (2.80"x24") Battiscopa - 9 mm - Rettificato

● Natural R9

Q7x1	EVOKE BEIGE		11,70	PZ	10	6,00	10,48	480,00	851,40	80
Q7x2	EVOKE BROWN		11,70							
Q7x4	EVOKE SAND		11,70							



EVOKE

Size	Code	Colour	Euro	U.M.	Pcs / Box	Mq / Box	Kg / Box	Mq / Pallet	Kg / Pallet	Box / Pallet
------	------	--------	------	------	-----------	----------	----------	-------------	-------------	--------------

GEO

EFFETTO PIETRA - STONE EFFECT - EFFET PIERRE - STEIN EFFEKT

120x120 (48"x48") (119,5x119,5)* - 9 mm - Rettificato

● Natural R9

HJC3	GEO BEIGE	102,80	MQ	2	2,86	60,80	57,12	1.251,00	20
HJC5	GEO GREY	98,80							
HJC2	GEO IVORY	102,80							
HJC4	GEO SILVER	98,80							
HJC6	GEO WALNUT	102,80							
HJC1	GEO WHITE	102,80							

60x120 (24"x48") - 9 mm - Rettificato

● Natural R9

HJD3	GEO BEIGE	83,50	MQ	2	1,44	31,93	50,40	1.138,00	35
HJD5	GEO GREY	80,30							
HJD2	GEO IVORY	83,50							
HJD4	GEO SILVER	80,30							
HJD6	GEO WALNUT	83,50							
HJD1	GEO WHITE	83,50							

■ Structured R10

HJ3D	GEO BEIGE	83,50							
HJ5D	GEO GREY	80,30							
HJ2D	GEO IVORY	83,50							
HJ4D	GEO SILVER	80,30							
HJ6D	GEO WALNUT	83,50							
HJ1D	GEO WHITE	83,50							

80x80 (32"x32") - 9 mm - Rettificato

● Natural R9

HJG3	GEO BEIGE	77,10	MQ	2	1,28	25,60	61,44	1.253,80	48
HJG5	GEO GREY	74,50							
HJG2	GEO IVORY	77,10							
HJG4	GEO SILVER	74,50							
HJG6	GEO WALNUT	77,10							
HJG1	GEO WHITE	77,10							

GEO

Size	Code	Colour	Euro	U.M.	Pcs / Box	Mq / Box	Kg / Box	Mq / Pallet	Kg / Pallet	Box / Pallet
------	------	--------	------	------	-----------	----------	----------	-------------	-------------	--------------

GEO

EFFETTO PIETRA - STONE EFFECT - EFFET PIERRE - STEIN EFFEKT

40x80 (16"x32") - 9 mm - Rettificato

● Natural R9

HJF3	GEO BEIGE	62,80	MQ	4	1,28	27,36	35,84	791,08	28
HJF5	GEO GREY	60,50							
HJF2	GEO IVORY	62,80							
HJF4	GEO SILVER	60,50							
HJF6	GEO WALNUT	62,80							
HJF1	GEO WHITE	62,80							

60x60 (24"x24") - 9 mm - Rettificato

● Natural R9

HJH3	GEO BEIGE	61,60	MQ	3	1,08	21,00	43,20	853,00	40
HJH5	GEO GREY	59,40							
HJH2	GEO IVORY	61,60							
HJH4	GEO SILVER	59,40							
HJH6	GEO WALNUT	61,60							
HJH1	GEO WHITE	61,60							

■ Structured R10

HJ3H	GEO BEIGE	61,60							
HJ5H	GEO GREY	59,40							
HJ2H	GEO IVORY	61,60							
HJ4H	GEO SILVER	59,40							
HJ6H	GEO WALNUT	61,60							
HJ1H	GEO WHITE	61,60							

▲ Grip R11

H3HJ	GEO BEIGE	61,60							
H5HJ	GEO GREY	59,40							
H2HJ	GEO IVORY	61,60							
H4HJ	GEO SILVER	59,40							
H6HJ	GEO WALNUT	61,60							
H1HJ	GEO WHITE	61,60							

GEO

Size	Code	Colour	Euro	U.M.	Pcs / Box	Mq / Box	Kg / Box	Mq / Pallet	Kg / Pallet	Box / Pallet
------	------	--------	------	------	-----------	----------	----------	-------------	-------------	--------------

GEO

EFFETTO PIETRA - STONE EFFECT - EFFET PIERRE - STEIN EFFEKT

30x60 (12"x24") - 9 mm - Rettificato

● Natural R9

HJI3	GEO BEIGE	51,40	MQ	7	1,26	25,00	50,40	1.016,00	40
HJI5	GEO GREY	49,90							
HJI2	GEO IVORY	51,40							
HJI4	GEO SILVER	49,90							
HJI6	GEO WALNUT	51,40							
HJI1	GEO WHITE	51,40							

▲ Grip R11

I3HJ	GEO BEIGE	51,40							
I5HJ	GEO GREY	49,90							
I2HJ	GEO IVORY	51,40							
I4HJ	GEO SILVER	49,90							
I6HJ	GEO WALNUT	51,40							
I1HJ	GEO WHITE	51,40							

120x120 (48"x48") - 20 mm - Rettificato

▲ Structured R11

3WHJ	GEO BEIGE	143,60	MQ	1	1,43	67,10	28,56	1.377,00	20
5WHJ	GEO GREY	138,10							
2WHJ	GEO IVORY	143,60							
4WHJ	GEO SILVER	138,10							

60x120 (24"x48") - 20 mm - Rettificato

▲ Structured R11

HJW3	GEO BEIGE	121,50	MQ	1	0,72	33,75	25,20	1.202,25	35
HJW5	GEO GREY	116,80							
HJW2	GEO IVORY	121,50							
HJW4	GEO SILVER	116,80							

GEO

Size	Code	Colour	Euro	U.M.	Pcs / Box	Mq / Box	Kg / Box	Mq / Pallet	Kg / Pallet	Box / Pallet
------	------	--------	------	------	-----------	----------	----------	-------------	-------------	--------------

GEO

EFFETTO PIETRA - STONE EFFECT - EFFET PIERRE - STEIN EFFEKT

60x120 (24"x48") Decoro 3D Wire - 9 mm - Rettificato

■ 3D

HJE2	GEO IVORY	92,00	MQ	2	1,44	31,93	50,40	1.138,00	35
HJE4	GEO SILVER	88,50							
HJE1	GEO WHITE	92,00							



60x120 (24"x48") Decoro - 9 mm - Rettificato

● Natural R9

HJE7	GEO SHAPE	85,10	MQ	2	1,44	31,93	50,40	1.138,00	35
------	-----------	-------	----	---	------	-------	-------	----------	----

30x30 (12"x12") Mosaico T36 (4,8x4,8) - 9 mm - Rettificato

● Natural R9

HJM3	GEO BEIGE	14,00	PZ	10	0,90	17,00	27,00	523,00	30
HJM5	GEO GREY	14,00							
HJM2	GEO IVORY	14,00							
HJM4	GEO SILVER	14,00							
HJM6	GEO WALNUT	14,00							
HJM1	GEO WHITE	14,00							

Venduti solo a scatole complete / Only full boxes sold /
Vendus par boîte complete / Nur volle Karton



33x120x4 (13"x48") Scalino incollato - 9 mm - Rettificato

● Natural R9

HJQ3	GEO BEIGE	235,10	PZ	2	0,79	18,40	19,01	454,60	24
HJQ5	GEO GREY	235,10							
HJQ2	GEO IVORY	235,10							
HJQ4	GEO SILVER	235,10							
HJQ6	GEO WALNUT	235,10							
HJQ1	GEO WHITE	235,10							

Lavorato su richiesta e venduto solo a scatole complete / Manufactured upon request
and only full boxes sold / Seulement à la demande et vendus par boîte complete / Nur
auf Anfrage und nur volle Karton

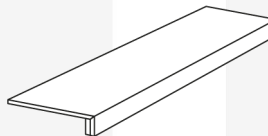

GEO

Size	Code	Colour	Euro	U.M.	Pcs / Box	Mq / Box	Kg / Box	Mq / Pallet	Kg / Pallet	Box / Pallet
------	------	--------	------	------	-----------	----------	----------	-------------	-------------	--------------

GEO

EFFETTO PIETRA - STONE EFFECT - EFFET PIERRE - STEIN EFFEKT

33x120x4 (13"x48") Scalino angolare incollato - 9 mm - Rettificato

● Natural R9

HJX3	GEO BEIGE ANG. DX	258,50	PZ	1	0,40	9,00	9,50	238,60	24
HJY3	GEO BEIGE ANG. SX	258,50							
HJX5	GEO GREY ANG. DX	258,50							
HJY5	GEO GREY ANG. SX	258,50							
HJX2	GEO IVORY ANG. DX	258,50							
HJY2	GEO IVORY ANG. SX	258,50							
HJX4	GEO SILVER ANG. DX	258,50							
HJY4	GEO SILVER ANG. SX	258,50							
HJX6	GEO WALNUT ANG. DX	258,50							
HJY6	GEO WALNUT ANG. SX	258,50							
HJX1	GEO WHITE ANG. DX	258,50							
HJY1	GEO WHITE ANG. SX	258,50							

Lavorato su richiesta e venduto solo a scatole complete / Manufactured upon request and only full boxes sold / Seulement à la demande et vendus par boîte complete / Nur auf Anfrage und nur volle Karton

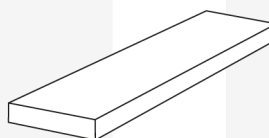

33x60x4 (13"x24") Scalino incollato - 9 mm - Rettificato

● Natural R9

HJS3	GEO BEIGE	113,20	PZ	4	0,79	21,70	19,01	533,80	24
HJS5	GEO GREY	113,20							
HJS2	GEO IVORY	113,20							
HJS4	GEO SILVER	113,20							
HJS6	GEO WALNUT	113,20							
HJS1	GEO WHITE	113,20							

Lavorato su richiesta e venduto solo a scatole complete / Manufactured upon request and only full boxes sold / Seulement à la demande et vendus par boîte complete / Nur auf Anfrage und nur volle Karton

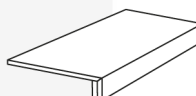

33x33x4 (13"x13") Scalino angolare incollato - 9 mm - Rettificato

● Natural R9

HJV3	GEO BEIGE	138,30	PZ	4	0,44	14,48	13,07	447,40	30
HJV5	GEO GREY	138,30							
HJV2	GEO IVORY	138,30							
HJV4	GEO SILVER	138,30							
HJV6	GEO WALNUT	138,30							
HJV1	GEO WHITE	138,30							

Lavorato su richiesta e venduto solo a scatole complete / Manufactured upon request and only full boxes sold / Seulement à la demande et vendus par boîte complete / Nur auf Anfrage und nur volle Karton



Size	Code	Colour	Euro	U.M.	Pcs / Box	Mq / Box	Kg / Box	Mq / Pallet	Kg / Pallet	Box / Pallet
------	------	--------	------	------	-----------	----------	----------	-------------	-------------	--------------

GEO

EFFETTO PIETRA - STONE EFFECT - EFFET PIERRE - STEIN EFFEKT

4,6x120 (1.80"x48") Battiscopa - 9 mm - Rettificato

● Natural R9

				Mt						
HJ3R	GEO BEIGE	24,70	PZ	6	7,20	7,80	345,60	387,40	48	
HJ5R	GEO GREY	24,70		Venduti solo a scatole complete / Only full boxes sold / Vendus par boite complete / Nur volle Karton						
HJ2R	GEO IVORY	24,70								
HJ4R	GEO SILVER	24,70								
HJ6R	GEO WALNUT	24,70								
HJ1R	GEO WHITE	24,70								



7x80 (2.75"x32") Battiscopa - 9 mm - Rettificato

● Natural R9

				Mt						
R3HJ	GEO BEIGE	13,30	PZ	8	6,40	9,30	460,80	682,60	72	
R5HJ	GEO GREY	13,30		Venduti solo a scatole complete / Only full boxes sold / Vendus par boite complete / Nur volle Karton						
R2HJ	GEO IVORY	13,30								
R4HJ	GEO SILVER	13,30								
R6HJ	GEO WALNUT	13,30								
R1HJ	GEO WHITE	13,30								



7,2x60 (2.80"x24") Battiscopa - 9 mm - Rettificato

● Natural R9

				Mt						
HJR3	GEO BEIGE	11,70	PZ	10	6,00	10,48	480,00	851,40	80	
HJR5	GEO GREY	11,70		Venduti solo a scatole complete / Only full boxes sold / Vendus par boite complete / Nur volle Karton						
HJR2	GEO IVORY	11,70								
HJR4	GEO SILVER	11,70								
HJR6	GEO WALNUT	11,70								
HJR1	GEO WHITE	11,70								



GEO

Size	Code	Colour	Euro	U.M.	Pcs / Box	Mq / Box	Kg / Box	Mq / Pallet	Kg / Pallet	Box / Pallet
------	------	--------	------	------	-----------	----------	----------	-------------	-------------	--------------

HERITAGE

EFFETTO PIETRA - STONE EFFECT - EFFET PIERRE - STEIN EFFEKT

120x120 (48"x48") (119,5x119,5)* - 9 mm - Rettificato

□ Spazzolato R10

IJB3	HERITAGE BEIGE	102,50	MQ	2	2,86	60,80	57,12	1.251,00	20
IJB4	HERITAGE GREY	102,50							
IJB2	HERITAGE IVORY	102,50							
IJB1	HERITAGE PEARL	102,50							

60x120 (24"x48") - 9 mm - Rettificato

□ Spazzolato R10

IJD3	HERITAGE BEIGE	86,00	MQ	2	1,44	31,93	50,40	1.138,00	35
IJD4	HERITAGE GREY	86,00							
IJD2	HERITAGE IVORY	86,00							
IJD1	HERITAGE PEARL	86,00							

60x60 (24"x24") - 9 mm - Rettificato

□ Spazzolato R10

IJH3	HERITAGE BEIGE	63,30	MQ	3	1,08	21,00	43,20	853,00	40
IJH4	HERITAGE GREY	63,30							
IJH2	HERITAGE IVORY	63,30							
IJH1	HERITAGE PEARL	63,30							

▲ Structured R11

H1I3	HERITAGE BEIGE	63,30							
H4IJ	HERITAGE GREY	63,30							
H2IJ	HERITAGE IVORY	63,30							
H3IJ	HERITAGE PEARL	63,30							

HERITAGE

Size	Code	Colour	Euro	U.M.	Pcs / Box	Mq / Box	Kg / Box	Mq / Pallet	Kg / Pallet	Box / Pallet
------	------	--------	------	------	-----------	----------	----------	-------------	-------------	--------------

HERITAGE

EFFETTO PIETRA - STONE EFFECT - EFFET PIERRE - STEIN EFFEKT

30x60 (12"x24") - 9 mm - Rettificato

▣ Spazzolato R10

IJI3	HERITAGE BEIGE	53,00	MQ	7	1,26	25,00	50,40	1.016,00	40
IJI4	HERITAGE GREY	53,00							
IJI2	HERITAGE IVORY	53,00							
IJI1	HERITAGE PEARL	53,00							

▲ Structured R11

I3IJ	HERITAGE BEIGE	53,00							
I4IJ	HERITAGE GREY	53,00							
I2IJ	HERITAGE IVORY	53,00							
I1IJ	HERITAGE PEARL	53,00							

60x120 (24"x48") - 20 mm - Rettificato

▲ Structured R11

IJW3	HERITAGE BEIGE	121,50	MQ	1	0,72	33,75	25,20	1.202,25	35
IJW4	HERITAGE GREY	121,50							
IJW2	HERITAGE IVORY	121,50							
IJW1	HERITAGE PEARL	121,50							

HERITAGE

60x120 (24"x48") Decoro - 9 mm - Rettificato

● Natural R9

IJ01	HERITAGE GEOMETRIC CORAL	97,30	MQ	2	1,44	31,93	50,40	1.138,00	35
IJ03	HERITAGE GEOMETRIC MIST	97,30							
IJ04	HERITAGE GEOMETRIC OCEAN	97,30							
IJ02	HERITAGE GEOMETRIC SAND	97,30							

60x120 (24"x48") Decoro Line 3D - 9 mm - Rettificato

■ 3D

IJ34	HERITAGE GREY	92,20	MQ	2	1,44	31,93	50,40	1.138,00	35
IJ32	HERITAGE IVORY	92,20							
IJ31	HERITAGE PEARL	92,20							

Size	Code	Colour	Euro	U.M.	Pcs / Box	Mq / Box	Kg / Box	Mq / Pallet	Kg / Pallet	Box / Pallet
------	------	--------	------	------	-----------	----------	----------	-------------	-------------	--------------

HERITAGE

EFFETTO PIETRA - STONE EFFECT - EFFET PIERRE - STEIN EFFEKT

30x30 (12"x12") Mosaico T100 (2,8x2,8) - 9 mm - Rettificato

□ Spazzolato R10

IJM3	HERITAGE BEIGE	27,80	PZ	6	0,54	11,20	27,00	523,00	48
IJM4	HERITAGE GREY	27,80							
IJM2	HERITAGE IVORY	27,80							
IJM1	HERITAGE PEARL	27,80							

Venduti solo a scatole complete / Only full boxes sold /
Vendus par boîte complete / Nur volle Karton

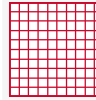

33x120x4 (13"x48") Scalino incollato - 9 mm - Rettificato

□ Spazzolato R10

IJQ3	HERITAGE BEIGE	235,40	PZ	2	0,79	18,40	19,01	454,60	24
IJQ4	HERITAGE GREY	235,40							
IJQ2	HERITAGE IVORY	235,40							
IJQ1	HERITAGE PEARL	235,40							

Lavorato su richiesta e venduto solo a scatole complete / Manufactured upon request
and only full boxes sold / Seulement à la demande et vendus par boîte complete / Nur
auf Anfrage und nur volle Karton

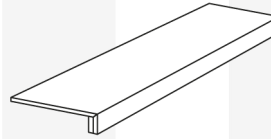

33x120x4 (13"x48") Scalino angolare incollato - 9 mm - Rettificato

□ Spazzolato R10

IJX3	HERITAGE BEIGE ANG. DX	258,50	PZ	1	0,40	9,00	9,50	238,60	24
IJY3	HERITAGE BEIGE ANG. SX	258,50							
IJX4	HERITAGE GREY ANG. DX	258,50							
IJY4	HERITAGE GREY ANG. SX	258,50							
IJX2	HERITAGE IVORY ANG. DX	258,50							
IJY2	HERITAGE IVORY ANG. SX	258,50							
IJX1	HERITAGE PEARL ANG. DX	258,50							
IJY1	HERITAGE PEARL ANG. SX	258,50							

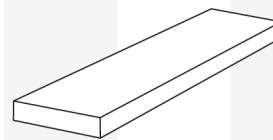

33x60x4 (13"x24") Scalino incollato - 9 mm - Rettificato

▲ Structured R11

S3IJ	HERITAGE BEIGE	113,30	PZ	4	0,79	21,70	19,01	533,80	24
S4IJ	HERITAGE GREY	113,30							
S2IJ	HERITAGE IVORY	113,30							
S1IJ	HERITAGE PEARL	113,30							

Lavorato su richiesta e venduto solo a scatole complete / Manufactured upon request
and only full boxes sold / Seulement à la demande et vendus par boîte complete / Nur
auf Anfrage und nur volle Karton

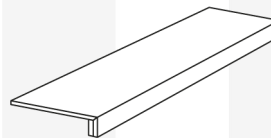

Size	Code	Colour	Euro	U.M.	Pcs / Box	Mq / Box	Kg / Box	Mq / Pallet	Kg / Pallet	Box / Pallet
------	------	--------	------	------	--------------	-------------	-------------	----------------	----------------	-----------------

HERITAGE

EFFETTO PIETRA - STONE EFFECT - EFFET PIERRE - STEIN EFFEKT

33x33x4 (13"x13") Scalino angolare incollato - 9 mm - Rettificato

▲ Structured R11

V3IJ	HERITAGE BEIGE	138,50	PZ	4	0,44	14,48	13,07	447,40	30
V4IJ	HERITAGE GREY	138,50							
V2IJ	HERITAGE IVORY	138,50							
V1IJ	HERITAGE PEARL	138,50							

Lavorato su richiesta e venduto solo a scatole complete / Manufactured upon request and only full boxes sold / Seulement à la demande et vendus par boîte complete / Nur auf Anfrage und nur volle Karton

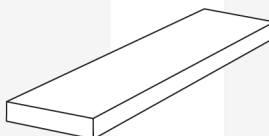

4,6x120 (1.80"x48") Battiscopa - 9 mm - Rettificato

□ Spazzolato R10

				Mt					
IJR3	HERITAGE BEIGE	24,70	PZ	6	7,20	7,80	345,60	387,40	48
IJR4	HERITAGE GREY	24,70							
IJR2	HERITAGE IVORY	24,70							
IJR1	HERITAGE PEARL	24,70							

Venduti solo a scatole complete / Only full boxes sold / Vendus par boîte complete / Nur volle Karton



7,2x60 (2.80"x24") Battiscopa - 9 mm - Rettificato

□ Spazzolato R10

				Mt					
IJ3R	HERITAGE BEIGE	11,80	PZ	10	6,00	10,48	480,00	851,40	80
IJ4R	HERITAGE GREY	11,80							
IJ2R	HERITAGE IVORY	11,80							
IJ1R	HERITAGE PEARL	11,80							

Venduti solo a scatole complete / Only full boxes sold / Vendus par boîte complete / Nur volle Karton



HERITAGE

Size	Code	Colour	Euro	U.M.	Pcs / Box	Mq / Box	Kg / Box	Mq / Pallet	Kg / Pallet	Box / Pallet
------	------	--------	------	------	--------------	-------------	-------------	----------------	----------------	-----------------

IKON

EFFETTO CEMENTO - CONCRETE EFFECT - EFFET CIMENT - ZEMENT EFFEKT

120x278 (48"x110") (119,5x278)* - 6 mm - Rettificato

● Natural R9

IKN4	IKON SILVER	129,10	MQ	1	3,32	49,56	59,80	990,08	18
IKN5	IKON WHITE	129,10							

Addebito cassa leggera (max7pz) (prezzo netto) / Light crate charge (max7pz) (net price) / Débit de caisse (max7pz) (prix net) / Kasse belasten (max7pz) (Nettopreis) - € 100
 Addebito cassa (prezzo netto) / Crate charge (net price) / Palette supplémentaire (prix net) / Aufreispalette (Nettopreis) - € 160
 Addebito cavalletto 18pz (prezzo netto) / Extra rack 18pcs (net price) / Chevalet supplémentaire 18pcs (prix net) / Aufpreisgestell 18St (Nettopreis) - € 270
 Addebito cavalletto 42pz (prezzo netto) / Extra rack 42pcs (net price) / Chevalet supplémentaire 42pcs (prix net) / Aufpreisgestell 42St (Nettopreis) - € 270

120x120 (48"x48") (119,5x119,5)* - 9 mm - Rettificato

● Natural R9

IKb4	IKON SILVER	102,80	MQ	2	2,86	60,80	57,12	1.251,00	20
IKb5	IKON WHITE	102,80							

■ Grip R10

IKB4	IKON SILVER	102,80							
IKB5	IKON WHITE	102,80							

60x120 (24"x48") - 9 mm - Rettificato

● Natural R9

IKM4	IKON SILVER	86,10	MQ	2	1,44	31,93	50,40	1.138,00	35
IKM5	IKON WHITE	86,10							

■ Grip R10

IKC4	IKON SILVER	86,10							
IKC5	IKON WHITE	86,10							

80x80 (32"x32") - 9 mm - Rettificato

● Natural R9

EKG3	IKON SILVER	76,70	MQ	2	1,28	25,60	61,44	1.253,80	48
EKG4	IKON WHITE	76,70							

IKON

Size	Code	Colour	Euro	U.M.	Pcs / Box	Mq / Box	Kg / Box	Mq / Pallet	Kg / Pallet	Box / Pallet
------	------	--------	------	------	-----------	----------	----------	-------------	-------------	--------------

IKON

EFFETTO CEMENTO - CONCRETE EFFECT - EFFET CIMENT - ZEMENT EFFEKT

60x60 (24"x24") - 9 mm - Rettificato

● Natural R9

IKF4	IKON SILVER	63,10	MQ	3	1,08	21,00	43,20	853,00	40
IKF5	IKON WHITE	63,10							

■ Grip R10

IKE4	IKON SILVER	63,10							
IKE5	IKON WHITE	63,10							

30x60 (12"x24") - 9 mm - Rettificato

■ Grip R10

IK4I	IKON SILVER	52,60	MQ	7	1,26	25,00	50,40	1.016,00	40
IK5I	IKON WHITE	52,60							

▲ Grip R11

IK4K	IKON SILVER	54,00							
IK5K	IKON WHITE	54,00							

9,7x60 (3.80"x24") - 9 mm - Rettificato

■ Grip R10

IKI4	IKON SILVER	85,70	MQ	10	0,58	12,75	34,92	781,00	60
IKI5	IKON WHITE	85,70							

30x60 (12"x24") Decoro Docks - 9 mm - Rettificato

● Natural R9

IK4M	IKON SILVER	24,70	PZ	5	0,90	17,50	35,10	695,50	39
IK5M	IKON WHITE	24,70							

Venduti solo a scatole complete / Only full boxes sold /
Vendus par boite complete / Nur volle Karton

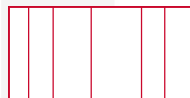

9,7x60 (3.80"x24") Listello Up - 9 mm - Rettificato

■ Grip R10

IKL4	IKON SILVER	121,10	MQ	8	0,47	10,48	27,96	641,80	60
IKL5	IKON WHITE	121,10							

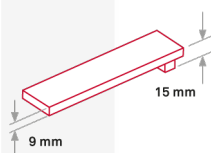

IKON

Size	Code	Colour	Euro	U.M.	Pcs / Box	Mq / Box	Kg / Box	Mq / Pallet	Kg / Pallet	Box / Pallet
------	------	--------	------	------	-----------	----------	----------	-------------	-------------	--------------

IKON

EFFETTO CEMENTO - CONCRETE EFFECT - EFFET CIMENT - ZEMENT EFFEKT

30x30 (12"x12") Mosaico T100 (2,8x2,8) - 9 mm - Rettificato

● Natural R9

IK04	IKON SILVER		27,80	PZ	6	0,54	11,20	25,00	550,60	48
IK05	IKON WHITE		27,80							

Venduti solo a scatole complete / Only full boxes sold /
Vendus par boîte complete / Nur volle Karton



33x120x4 (13"x48") Scalino incollato - 9 mm - Rettificato

● Natural R9

IK4S	IKON SILVER		235,10	PZ	2	0,79	18,40	19,01	454,60	24
IK5S	IKON WHITE		235,10							

Lavorato su richiesta e venduto solo a scatole complete / Manufactured upon request
and only full boxes sold / Seulement à la demande et vendus par boîte complete / Nur
auf Anfrage und nur volle Karton

■ Grip R10

IKS4	IKON SILVER		235,10							
IKS5	IKON WHITE		235,10							

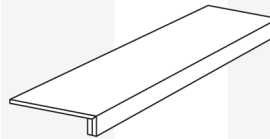

33x120x4 (13"x48") Scalino angolare incollato - 9 mm - Rettificato

● Natural R9

IK4T	IKON SILVER ANG. DX		258,50	PZ	1	0,40	9,00	9,50	238,60	24
IK4U	IKON SILVER ANG. SX		258,50							
IK5T	IKON WHITE ANG. DX		258,50							
IK5U	IKON WHITE ANG. SX		258,50							

Lavorato su richiesta e venduto solo a scatole complete / Manufactured upon request
and only full boxes sold / Seulement à la demande et vendus par boîte complete / Nur
auf Anfrage und nur volle Karton

■ Grip R10

IKT4	IKON SILVER ANG. DX		258,50							
IKU4	IKON SILVER ANG. SX		258,50							
IKT5	IKON WHITE ANG. DX		258,50							
IKU5	IKON WHITE ANG. SX		258,50							

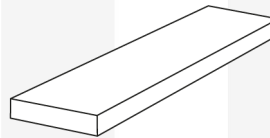

33x60x4 (13"x24") Scalino incollato - 9 mm - Rettificato

● Natural R9

IK4V	IKON SILVER		113,20	PZ	4	0,79	21,70	19,01	533,80	24
IK5V	IKON WHITE		113,20							

Lavorato su richiesta e venduto solo a scatole complete / Manufactured upon request
and only full boxes sold / Seulement à la demande et vendus par boîte complete / Nur
auf Anfrage und nur volle Karton

■ Grip R10

IKV4	IKON SILVER		113,20							
IKV5	IKON WHITE		113,20							

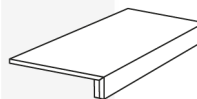

Size	Code	Colour	Euro	U.M.	Pcs / Box	Mq / Box	Kg / Box	Mq / Pallet	Kg / Pallet	Box / Pallet
------	------	--------	------	------	-----------	----------	----------	-------------	-------------	--------------

IKON

EFFETTO CEMENTO - CONCRETE EFFECT - EFFET CIMENT - ZEMENT EFFEKT

33x33x4 (13"x13") Scalino angolare incollato - 9 mm - Rettificato

● Natural R9

IK4Z	IKON SILVER	138,30	PZ	4	0,44	14,48	13,07	447,40	30
IK5Z	IKON WHITE	138,30							

Lavorato su richiesta e venduto solo a scatole complete / Manufactured upon request and only full boxes sold / Seulement à la demande et vendus par boîte complete / Nur auf Anfrage und nur volle Karton

■ Grip R10

IKZ4	IKON SILVER	138,30							
IKZ5	IKON WHITE	138,30							



7,2x60 (2.80"x24") Battiscopa - 9 mm - Rettificato

● Natural R9

				Mt						
R4IK	IKON SILVER	11,70	PZ	10	6,00	10,48	480,00	851,40	80	
R5IK	IKON WHITE	11,70								

Venduti solo a scatole complete / Only full boxes sold / Vendus par boîte complete / Nur volle Karton



Size	Code	Colour	Euro	U.M.	Pcs / Box	Mq / Box	Kg / Box	Mq / Pallet	Kg / Pallet	Box / Pallet
------	------	--------	------	------	--------------	-------------	-------------	----------------	----------------	-----------------

INTERNO4

EFFETTO MARMO - MARBLE EFFECT - EFFET MARBRE - MARMOR EFFEKT

120x278 (48"x110") (119,5x278)* - 6 mm - Rettificato

◆ Lappato

EB1A	INTERNO4 BRECCIA TORTONA	167,90	MQ	1	3,32	49,56	59,80	990,08	18
EB3A	INTERNO4 CALACATTA SAN BABILA	167,90							

Addebito cassa leggera (max7pz) (prezzo netto) / Light crate charge (max7pz) (net price) / Débit de caisse (max7pz) (prix net) / Kasse belasten (max7pz) (Nettopreis) - € 100
 Addebito cassa (prezzo netto) / Crate charge (net price) / Palette supplémentaire (prix net) / Aufreispalette (Nettopreis) - € 160
 Addebito cavalletto 18pz (prezzo netto) / Extra rack 18pcs (net price) / Chevalet supplémentaire 18pcs (prix net) / Aufpreisgestell 18St (Nettopreis) - € 270
 Addebito cavalletto 42pz (prezzo netto) / Extra rack 42pcs (net price) / Chevalet supplémentaire 42pcs (prix net) / Aufpreisgestell 42St (Nettopreis) - € 270

120x120 (48"x48") (119,5x119,5)* - 9 mm - Rettificato

◆ Lappato

EB1C	INTERNO4 BRECCIA TORTONA	143,70	MQ	2	2,86	60,80	57,12	1.251,00	20
EB3C	INTERNO4 CALACATTA SAN BABILA	143,70							

INTERNO4

60x120 (24"x48") - 9 mm - Rettificato

◆ Lappato

EB1D	INTERNO4 BRECCIA TORTONA	113,60	MQ	2	1,44	31,93	50,40	1.138,00	35
EB3D	INTERNO4 CALACATTA SAN BABILA	113,60							

● Natural R9

EBD1	INTERNO4 BRECCIA TORTONA	87,10							
EBD3	INTERNO4 CALACATTA SAN BABILA	87,10							

1x90 Coprispigo - 6 mm - Rettificato

◆ Lappato

EBU1	INTERNO4 BRECCIA TORTONA	46,70	PZ	6	5,40	1,35	0,00	0,00	0
EBU3	INTERNO4 CALACATTA SAN BABILA	46,70							

Lavorato su richiesta e venduto solo a scatole complete / Manufactured upon request and only full boxes sold / Seulement à la demande et vendus par boîte complete / Nur auf Anfrage und nur volle Karton



Size	Code	Colour	Euro	U.M.	Pcs / Box	Mq / Box	Kg / Box	Mq / Pallet	Kg / Pallet	Box / Pallet
------	------	--------	------	------	-----------	----------	----------	-------------	-------------	--------------

INTERNO4

EFFETTO MARMO - MARBLE EFFECT - EFFET MARBRE - MARMOR EFFEKT

1x1 Coprispigolo angolare - 6 mm - Rettificato

◆ Lappato

EBW1	INTERNO4 BRECCIA TORTONA		34,20	PZ	20	0,00	0,04	0,00	0,00	0
EBW3	INTERNO4 CALACATTA SAN BABILA		34,20							

Lavorato su richiesta e venduto solo a scatole complete / Manufactured upon request and only full boxes sold / Seulement à la demande et vendus par boîte complete / Nur auf Anfrage und nur volle Karton



1,4x60 Coprispigolo - 9 mm - Rettificato

◆ Lappato

EBJ1	INTERNO4 BRECCIA TORTONA		27,00	PZ	6	3,60	0,76	0,00	0,00	0
EBJ3	INTERNO4 CALACATTA SAN BABILA		27,00							

Lavorato su richiesta e venduto solo a scatole complete / Manufactured upon request and only full boxes sold / Seulement à la demande et vendus par boîte complete / Nur auf Anfrage und nur volle Karton



35,2x30 Mosaico Rombi (10x10) - 9 mm - Rettificato

◆ Lappato

EB10	INTERNO4 BRECCIA TORTONA		35,30	PZ	4	0,42	8,36	20,16	414,28	48
EB30	INTERNO4 CALACATTA SAN BABILA		35,30							

Venduti solo a scatole complete / Only full boxes sold / Vendus par boîte complete / Nur volle Karton



30x30 (12"x12") Mosaico T36 (4,8x4,8) - 9 mm - Rettificato

◆ Lappato

EB1M	INTERNO4 BRECCIA TORTONA		20,20	PZ	10	0,90	17,00	27,00	523,00	30
EB3M	INTERNO4 CALACATTA SAN BABILA		20,20							

Venduti solo a scatole complete / Only full boxes sold / Vendus par boîte complete / Nur volle Karton



1,4x1,4 Coprispigolo angolare - 9 mm - Rettificato

◆ Lappato

EBK1	INTERNO4 BRECCIA TORTONA		34,20	PZ	20	0,00	0,06	0,00	0,00	0
EBK3	INTERNO4 CALACATTA SAN BABILA		34,20							

Lavorato su richiesta e venduto solo a scatole complete / Manufactured upon request and only full boxes sold / Seulement à la demande et vendus par boîte complete / Nur auf Anfrage und nur volle Karton



INTERNO4

Size	Code	Colour	Euro	U.M.	Pcs / Box	Mq / Box	Kg / Box	Mq / Pallet	Kg / Pallet	Box / Pallet
------	------	--------	------	------	--------------	-------------	-------------	----------------	----------------	-----------------

INTERNO4

EFFETTO MARMO - MARBLE EFFECT - EFFET MARBRE - MARMOR EFFEKT

33x120x4 (13"x48") Scalino incollato - 9 mm - Rettificato

◆ Lappato

EB1Q	INTERNO4 BRECCIA TORTONA	268,50	PZ	2	0,79	18,40	19,01	454,60	24
EB3Q	INTERNO4 CALACATTA SAN BABILA	268,50							

Lavorato su richiesta e venduto solo a scatole complete / Manufactured upon request and only full boxes sold / Seulement à la demande et vendus par boîte complete / Nur auf Anfrage und nur volle Karton

● Natural R9

EBQ1	INTERNO4 BRECCIA TORTONA	235,10							
EBQ3	INTERNO4 CALACATTA SAN BABILA	235,10							

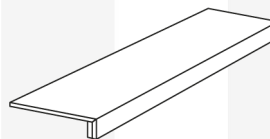

33x120x4 (13"x48") Scalino angolare incollato - 9 mm - Rettificato

◆ Lappato

EB1X	BRECCIA TORTONA ANG. DX	295,30	PZ	1	0,40	9,00	9,50	238,60	24
EB1Y	BRECCIA TORTONA ANG. SX	295,30							
EB3X	CALACATTA SAN BABILA ANG. DX	295,30							
EB3Y	CALACATTA SAN BABILA ANG. SX	295,30							

Lavorato su richiesta e venduto solo a scatole complete / Manufactured upon request and only full boxes sold / Seulement à la demande et vendus par boîte complete / Nur auf Anfrage und nur volle Karton

● Natural R9

EBX1	BRECCIA TORTONA ANG. DX	258,50							
EBY1	BRECCIA TORTONA ANG. SX	258,50							
EBX3	CALACATTA SAN BABILA ANG. DX	258,50							
EBY3	CALACATTA SAN BABILA ANG. SX	258,50							

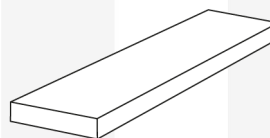

33x60x4 (13"x24") Scalino incollato - 9 mm - Rettificato

◆ Lappato

EB1S	INTERNO4 BRECCIA TORTONA	129,40	PZ	4	0,79	21,70	19,01	533,80	24
EB3S	INTERNO4 CALACATTA SAN BABILA	129,40							

Lavorato su richiesta e venduto solo a scatole complete / Manufactured upon request and only full boxes sold / Seulement à la demande et vendus par boîte complete / Nur auf Anfrage und nur volle Karton

● Natural R9

EBS1	INTERNO4 BRECCIA TORTONA	113,70							
EBS3	INTERNO4 CALACATTA SAN BABILA	113,70							

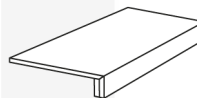

33x33x4 (13"x13") Scalino angolare incollato - 9 mm - Non rettificato

◆ Lappato

EB1V	INTERNO4 BRECCIA TORTONA	158,00	PZ	4	0,44	14,48	13,07	447,40	30
EB3V	INTERNO4 CALACATTA SAN BABILA	158,00							

Lavorato su richiesta e venduto solo a scatole complete / Manufactured upon request and only full boxes sold / Seulement à la demande et vendus par boîte complete / Nur auf Anfrage und nur volle Karton

● Natural R9

EBV1	INTERNO4 BRECCIA TORTONA	138,80							
EBV3	INTERNO4 CALACATTA SAN BABILA	138,80							



Size	Code	Colour	Euro	U.M.	Pcs / Box	Mq / Box	Kg / Box	Mq / Pallet	Kg / Pallet	Box / Pallet
------	------	--------	------	------	--------------	-------------	-------------	----------------	----------------	-----------------

INTERNO4

EFFETTO MARMO - MARBLE EFFECT - EFFET MARBRE - MARMOR EFFEKT

4,6x120 (1.80"x48") Battiscopa - 9 mm - Rettificato

◆ Lappato

					Mt				
EB1R	INTERNO4 BRECCIA TORTONA	34,20	PZ	6	7,20	7,80	345,60	387,40	48
EB3R	INTERNO4 CALACATTA SAN BABILA	34,20							

Venduti solo a scatole complete / Only full boxes sold /
Vendus par boîte complete / Nur volle Karton

● Natural R9

EBR1	INTERNO4 BRECCIA TORTONA	24,70							
EBR3	INTERNO4 CALACATTA SAN BABILA	24,70							



INTERNO4

Size	Code	Colour	Euro	U.M.	Pcs / Box	Mq / Box	Kg / Box	Mq / Pallet	Kg / Pallet	Box / Pallet
------	------	--------	------	------	-----------	----------	----------	-------------	-------------	--------------

JOURNEY

EFFETTO LEGNO - WOOD EFFECT - EFFET BOIS - HOLZ EFFEKT

20x120 (8"x48") - 9 mm - Rettificato

● Natural R9

F1HS	JOURNEY ALMOND		70,60	MQ	6	1,44	29,00	60,48	1.231,00	42
F6HS	JOURNEY BONE		70,60							
F4HS	JOURNEY CARAMEL		73,30							
F2HS	JOURNEY HONEY		73,30							

10x120 (4"x48") - 9 mm - Rettificato

● Natural R9

HS1E	JOURNEY ALMOND		89,50	MQ	10	1,20	24,56	43,72	897,00	36
HS4E	JOURNEY BONE		89,50							
HS3E	JOURNEY CARAMEL		93,10							
HS2E	JOURNEY HONEY		93,10							

5x120 (2"x48") - 9 mm - Rettificato

● Natural R9

HS1I	JOURNEY ALMOND		103,20	MQ	20	1,20	24,56	43,72	897,00	36
HS4I	JOURNEY BONE		103,20							
HS3I	JOURNEY CARAMEL		107,10							
HS2I	JOURNEY HONEY		107,10							

30x120 (12"x48") - 20 mm - Rettificato

▲ Structured R11

HS4W	JOURNEY BONE		132,90	MQ	2	0,72	33,05	25,92	1.203,00	36
HSW2	JOURNEY HONEY		138,30							

60x120 (24"x48") Decoro - 9 mm - Rettificato

● Natural R9

J001	JOURNEY BLOSSOM		97,30	MQ	2	1,44	31,93	50,40	1.138,00	35
J002	JOURNEY LEAVES		97,30							
J004	JOURNEY SPRINGTIME		97,30							
J003	JOURNEY WATERCOLOR		97,30							

JOURNEY

Size	Code	Colour	Euro	U.M.	Pcs / Box	Mq / Box	Kg / Box	Mq / Pallet	Kg / Pallet	Box / Pallet
------	------	--------	------	------	--------------	-------------	-------------	----------------	----------------	-----------------

JOURNEY

EFFETTO LEGNO - WOOD EFFECT - EFFET BOIS - HOLZ EFFEKT

7,5x45 Chevron - 9 mm - Non rettificato

● Natural R9

HSC1	JOURNEY ALMOND	69,80	MQ	26	0,88	19,00	49,10	1.064,00	56
HS4C	JOURNEY BONE	69,80							
HS3C	JOURNEY CARAMEL	72,60							
HSC2	JOURNEY HONEY	72,60							

All'interno di ciascuna scatola è garantita la presenza di almeno 12 coppie A+B. / Inside each box is guaranteed the presence of at least 12 pairs A + B. / À l'intérieur de chaque boîte, la présence d'au moins 12 paires A+B est garantie. / In jeder Box sind mindestens 12 A+B-Paare enthalten. / Dentro de cada caja se garantiza la presencia de al menos 12 pares A+B.



4,6x120 (1.80"x48") Battiscopa - 9 mm - Rettificato

● Natural R9

HS1R	JOURNEY ALMOND	24,70	PZ	6	7,20	7,80	345,60	387,40	48
HS5R	JOURNEY BONE	24,70							
HS3R	JOURNEY CARAMEL	24,70							
HS2R	JOURNEY HONEY	24,70							

Mt

Venduti solo a scatole complete / Only full boxes sold / Vendus par boîte complete / Nur volle Karton



JOURNEY

Size	Code	Colour	Euro	U.M.	Pcs / Box	Mq / Box	Kg / Box	Mq / Pallet	Kg / Pallet	Box / Pallet
------	------	--------	------	------	-----------	----------	----------	-------------	-------------	--------------

LAVICA

EFFETTO PIETRA - STONE EFFECT - EFFET PIERRE - STEIN EFFEKT

120x278 (48"x110") (119,5x278)* - 6 mm - Rettificato

● Natural R9

JMA2	LAVICA ANTHRACITE	128,80	MQ	1	3,32	49,56	59,80	990,08	18
------	-------------------	--------	----	---	------	-------	-------	--------	----



Addebito cassa leggera (max7pz) (prezzo netto) / Light crate charge (max7pz) (net price) / Débit de caisse (max7pz) (prix net) / Kasse belasten (max7pz) (Nettopreis) - € 100
 Addebito cassa (prezzo netto) / Crate charge (net price) / Palette supplémentaire (prix net) / Aufpreispalette (Nettopreis) - € 160
 Addebito cavalletto 18pz (prezzo netto) / Extra rack 18pcs (net price) / Chevalet supplémentaire 18pcs (prix net) / Aufpreisgestell 18St (Nettopreis) - € 270
 Addebito cavalletto 42pz (prezzo netto) / Extra rack 42pcs (net price) / Chevalet supplémentaire 42pcs (prix net) / Aufpreisgestell 42St (Nettopreis) - € 270

60x120 (24"x48") - 9 mm - Rettificato

× Silky

6DJM	LAVICA BLACK	88,10	MQ	2	1,44	31,93	50,40	1.138,00	35
------	--------------	-------	----	---	------	-------	-------	----------	----

□ Spazzolato R10

JM5D	LAVICA ANTHRACITE	83,40							
JM4D	LAVICA GREY	83,40							



80x80 (32"x32") - 9 mm - Rettificato

□ Spazzolato R10

JMG5	LAVICA ANTHRACITE	77,30	MQ	2	1,28	25,60	61,44	1.253,80	48
JMG4	LAVICA GREY	77,30							



7,5x60 (3"x24") - 9 mm - Non rettificato

× Silky

JM53	LAVICA BLACK	78,30	MQ	22	0,99	19,10	59,4	1.159,00	60
------	--------------	-------	----	----	------	-------	------	----------	----

□ Spazzolato R10

JM52	LAVICA ANTHRACITE	71,10							
JM51	LAVICA GREY	71,10							



60x120 (24"x48") - 20 mm - Rettificato

▲ Structured R11

JMW5	LAVICA ANTHRACITE	121,50	MQ	1	0,72	33,75	25,20	1.202,25	35
JMW4	LAVICA GREY	121,50							



Size	Code	Colour	Euro	U.M.	Pcs / Box	Mq / Box	Kg / Box	Mq / Pallet	Kg / Pallet	Box / Pallet
------	------	--------	------	------	-----------	----------	----------	-------------	-------------	--------------

LAVICA

EFFETTO PIETRA - STONE EFFECT - EFFET PIERRE - STEIN EFFEKT

20x120 (8"x48") Plisse - 9 mm - Rettificato

✕ Silky

6LJM	LAVICA BLACK	38,60	PZ	4	0,96	20,66	34,56	756,76	36
------	--------------	-------	----	---	------	-------	-------	--------	----

Venduti solo a scatole complete / Only full boxes sold /
Vendus par boite complete / Nur volle Karton

□ Spazzolato R10

JM5L	LAVICA ANTHRACITE	38,60							
JM4L	LAVICA GREY	38,60							



30x30 (12"x12") Mosaico listelli - 9 mm - Rettificato

✕ Silky

6MJM	LAVICA BLACK	20,60	PZ	11	0,99	17,00	27,00	523,00	36
------	--------------	-------	----	----	------	-------	-------	--------	----

Venduti solo a scatole complete / Only full boxes sold /
Vendus par boite complete / Nur volle Karton

□ Spazzolato R10

JM5M	LAVICA ANTHRACITE	20,60							
JM4M	LAVICA GREY	20,60							

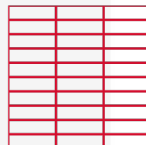

20x20 (8"x8") Decoro - 9 mm - Rettificato

● Natural R9

JMJ6	LAVICA ETNA ANTHRACITE	72,10	MQ	30	1,20	23,44	67,2	1.351,00	56
JMJ4	LAVICA STROMBOLI GREY	72,10							
JMJ5	LAVICA VESUVIO GREY	72,10							
JMJ7	LAVICA VULCANO ANTHRACITE	72,10							



33x120x4 (13"x48") Scalino incollato - 9 mm - Rettificato

✕ Silky

6QJM	LAVICA BLACK	235,40	PZ	2	0,79	18,40	19,01	454,60	24
------	--------------	--------	----	---	------	-------	-------	--------	----

Lavorato su richiesta e venduto solo a scatole complete / Manufactured upon request
and only full boxes sold / Seulement à la demande et vendus par boite complete / Nur
auf Anfrage und nur volle Karton

□ Spazzolato R10

JM5Q	LAVICA ANTHRACITE	235,40							
JM4Q	LAVICA GREY	235,40							

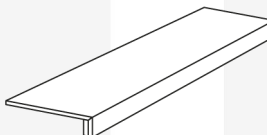

LAVICA

Size	Code	Colour	Euro	U.M.	Pcs / Box	Mq / Box	Kg / Box	Mq / Pallet	Kg / Pallet	Box / Pallet
------	------	--------	------	------	-----------	----------	----------	-------------	-------------	--------------

LAVICA

EFFETTO PIETRA - STONE EFFECT - EFFET PIERRE - STEIN EFFEKT

33x120x4 (13"x48") Scalino angolare incollato - 9 mm - Rettificato

✕ Silky

6XJM	LAVICA BLACK ANG. DX	258,50	PZ	1	0,40	9,00	9,50	238,60	200
6YJM	LAVICA BLACK ANG. SX	258,50							

Lavorato su richiesta e venduto solo a scatole complete / Manufactured upon request and only full boxes sold / Seulement à la demande et vendus par boîte complete / Nur auf Anfrage und nur volle Karton

□ Spazzolato R10

JM5X	LAVICA ANTHRACITE ANG. DX	258,50							
JM5Y	LAVICA ANTHRACITE ANG. SX	258,50							
JM4X	LAVICA GREY ANG. DX	258,50							
JM4Y	LAVICA GREY ANG. SX	258,50							

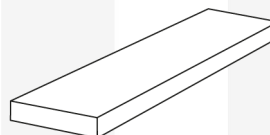

4,6x120 (1.80"x48") Battiscopa - 9 mm - Rettificato

✕ Silky

6RJM	LAVICA BLACK	24,70	PZ	6	7,20	7,80	345,60	387,40	48
------	--------------	-------	----	---	------	------	--------	--------	----

Venduti solo a scatole complete / Only full boxes sold / Vendus par boîte complete / Nur volle Karton

□ Spazzolato R10

JM5R	LAVICA ANTHRACITE	24,70							
JM4R	LAVICA GREY	24,70							



7x80 (2.75"x32") Battiscopa - 9 mm - Rettificato

□ Spazzolato R10

JMR5	LAVICA ANTHRACITE	13,40	PZ	8	6,40	9,30	460,80	682,60	72
------	-------------------	-------	----	---	------	------	--------	--------	----

Venduti solo a scatole complete / Only full boxes sold / Vendus par boîte complete / Nur volle Karton

JMR4 LAVICA GREY 13,40



LAVICA

Size	Code	Colour	Euro	U.M.	Pcs / Box	Mq / Box	Kg / Box	Mq / Pallet	Kg / Pallet	Box / Pallet
------	------	--------	------	------	-----------	----------	----------	-------------	-------------	--------------

LIMES

EFFETTO PIETRA - STONE EFFECT - EFFET PIERRE - STEIN EFFEKT

22,5x45,3 (9"x18") - 8,5 mm - Non rettificato

▲ Structured R11

2ZFC	LIMES PORFIDO COLD		42,70	MQ	13	1,32	22,80	52,65	912,00	40
3ZFC	LIMES PORFIDO WARM		44,30							
4ZFC	LIMES QUARTZ MULTICOLOR		42,70							
1ZFC	LIMES QUARTZ WHITE		44,30							

22,5x22,5 (9"x9") - 9 mm - Non rettificato

▲ Structured R11

2JFC	LIMES PORFIDO COLD		42,70	MQ	20	1,01	20,25	42,53	866,50	42
4JFC	LIMES QUARTZ MULTICOLOR		42,70							
1JFC	LIMES QUARTZ WHITE		44,30							

15x30x4 Terminale L monolitico - 8,5 mm - Non rettificato

▲ Structured R11

FCT2	LIMES PORFIDO COLD		19,70	PZ	8	0,36	9,00	17,28	445,00	48
FCT3	LIMES PORFIDO WARM		19,70							
FCT4	LIMES QUARTZ MULTICOLOR		19,70							
FCT1	LIMES QUARTZ WHITE		19,70							

7,2x45,3 (2.80"x18") Battiscopa - 9 mm - Non rettificato

▲ Structured R11

2RFC	LIMES PORFIDO COLD		7,20	PZ	12	5,44	7,90	456,62	676,60	84
3RFC	LIMES PORFIDO WARM		7,20							
4RFC	LIMES QUARTZ MULTICOLOR		7,20							
1RFC	LIMES QUARTZ WHITE		7,20							

Mt

Venduti solo a scatole complete / Only full boxes sold /
Vendus par boîte complete / Nur volle Karton

LIMES

Size	Code	Colour	Euro	U.M.	Pcs / Box	Mq / Box	Kg / Box	Mq / Pallet	Kg / Pallet	Box / Pallet
------	------	--------	------	------	-----------	----------	----------	-------------	-------------	--------------

LINEO

EFFETTO LEGNO - WOOD EFFECT - EFFET BOIS - HOLZ EFFEKT

20x120 (8"x48") - 9 mm - Rettificato

● Natural R9

F3F4	LINEO BROWN	72,10	MQ	6	1,44	29,00	60,48	1.231,00	42
F3F2	LINEO HONEY	69,40							
F3F3	LINEO SAND	69,40							
F3F7	LINEO WALNUT	69,40							
F3F1	LINEO WHITE	72,10							

4,6x120 (1.80"x48") Battiscopa - 9 mm - Rettificato

● Natural R9

					Mt				
F3R4	LINEO BROWN	24,70	PZ	6	7,20	7,80	345,60	387,40	48
F3R2	LINEO HONEY	24,70							
F3R3	LINEO SAND	24,70							
F3R7	LINEO WALNUT	24,70							
F3R1	LINEO WHITE	24,70							

Venduti solo a scatole complete / Only full boxes sold /
Vendus par boite complete / Nur volle Karton



LINEO

Size	Code	Colour	Euro	U.M.	Pcs / Box	Mq / Box	Kg / Box	Mq / Pallet	Kg / Pallet	Box / Pallet
------	------	--------	------	------	-----------	----------	----------	-------------	-------------	--------------

METAL STICKS

10x120 Stick - 8 mm - Rettificato

● Natural

RASF	METAL STICK ARANCIONE		39,00	PZ	6	0,72			0,00	999
MOSF	METAL STICK MOKA		39,00							
SFNE	METAL STICK NERO		49,30							
BRSF	METAL STICK OTTONE		49,30							
SISF	METAL STICK SILVER		39,00							
SFVA	METAL STICK VERDE		39,00							

0,5x60 Stick - 8 mm - Rettificato

● Natural

ECBG	METAL STICK GOLD		25,00	PZ	10	6,00	1,26	936,00	209,56	156
------	------------------	--	-------	----	----	------	------	--------	--------	-----

10x30 Stick - 8 mm - Rettificato

● Natural

ARSF	METAL STICK ARANCIONE		21,20	PZ	6	0,02			0,00	999
SFMO	METAL STICK MOKA		8,70							
NESF	METAL STICK NERO		14,10							
SFBR	METAL STICK OTTONE		12,50							
SFSI	METAL STICK SILVER		8,70							
VASF	METAL STICK VERDE		21,20							

METAL STICKS

Size	Code	Colour	Euro	U.M.	Pcs / Box	Mq / Box	Kg / Box	Mq / Pallet	Kg / Pallet	Box / Pallet
------	------	--------	------	------	-----------	----------	----------	-------------	-------------	--------------

MIDLAKE

EFFETTO PIETRA - STONE EFFECT - EFFET PIERRE - STEIN EFFEKT

22,5x45,3 (9"x18") - 8,5 mm - Non rettificato

▲ Structured R11

4ZD2	MIDLAKE ARDESIA	43,60	MQ	13	1,32	22,80	52,65	912,00	40
2ZD2	MIDLAKE PORFIDO	42,40							
3ZD2	MIDLAKE QUARTZBEIGE	42,40							
1ZD2	MIDLAKE QUARTZGREY	43,60							

60x90 (24"x36") - 20 mm - Rettificato

▲ Structured R11

D204	MIDLAKE ARDESIA	110,70	MQ	2	1,08	48,50	25,92	1.182,00	24
D202	MIDLAKE PORFIDO	107,30							
D203	MIDLAKE QUARTZBEIGE	107,30							
D201	MIDLAKE QUARTZGREY	110,70							

Disponibile anche con palletizzazione a 18 scatole. Verificare all'ordine la disponibilità / Also available with 18 boxes palletization. Check availability when ordering / Également disponible avec une palettisation de 18 caisses. Vérifier la disponibilité lors de la commande / Auch mit 18 Kartons Palettierung erhältlich. Verfügbarkeit bei Bestellung prüfen

MIDLAKE

15x30x4 Terminale L monolitico - 8,5 mm - Non rettificato

▲ Structured R11

D2T2	MIDLAKE PORFIDO	19,70	PZ	8	0,36	9,00	17,28	445,00	48
D2T3	MIDLAKE QUARTZBEIGE	19,70							
D2T1	MIDLAKE QUARTZGREY	19,70							

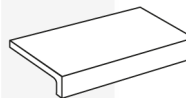

15x30x4 Terminale L monolitico - 9,5 mm - Non rettificato

▲ Structured R11

D2T4	MIDLAKE ARDESIA	19,70	PZ	8	0,36	9,00	17,28	445,00	48
------	-----------------	-------	----	---	------	------	-------	--------	----

Venduti solo a scatole complete / Only full boxes sold / Vendus par boîte complete / Nur volle Karton

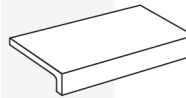

7,2x45,3 (2.80"x18") Battiscopa - 9 mm - Non rettificato

▲ Structured R11

4RD2	MIDLAKE ARDESIA	7,20	PZ	12	5,44	7,90	456,62	676,60	84
2RD2	MIDLAKE PORFIDO	7,20							
3RD2	MIDLAKE QUARTZBEIGE	7,20							
1RD2	MIDLAKE QUARTZGREY	7,20							

Venduti solo a scatole complete / Only full boxes sold / Vendus par boîte complete / Nur volle Karton



Size	Code	Colour	Euro	U.M.	Pcs / Box	Mq / Box	Kg / Box	Mq / Pallet	Kg / Pallet	Box / Pallet
------	------	--------	------	------	--------------	-------------	-------------	----------------	----------------	-----------------

MOOV

EFFETTO CEMENTO - CONCRETE EFFECT - EFFET CIMENT - ZEMENT EFFEKT

120x278 (48"x110") (119,5x278)* - 6 mm - Rettificato

● Natural R9

Y8V3	MOOV GREY	120,20	MQ	1	3,32	49,56	59,80	990,08	18
Y8V1	MOOV IVORY	127,00							

Addebito cassa leggera (max7pz) (prezzo netto) / Light crate charge (max7pz) (net price) / Débit de caisse (max7pz) (prix net) / Kasse belasten (max7pz) (Nettopreis) - € 100
 Addebito cassa (prezzo netto) / Crate charge (net price) / Palette supplémentaire (prix net) / Aufreispalette (Nettopreis) - € 160
 Addebito cavalletto 18pz (prezzo netto) / Extra rack 18pcs (net price) / Chevalet supplémentaire 18pcs (prix net) / Aufpreisgestell 18St (Nettopreis) - € 270
 Addebito cavalletto 42pz (prezzo netto) / Extra rack 42pcs (net price) / Chevalet supplémentaire 42pcs (prix net) / Aufpreisgestell 42St (Nettopreis) - € 270

120x240 (48"x96") (119,5x239)* - 9 mm - Rettificato

● Natural R9

y874	MOOV ANTHRACITE	129,50	MQ	1	2,86	61,60	51,41	1.203,80	18
y872	MOOV BEIGE	122,50							
y873	MOOV GREY	122,50							
y871	MOOV IVORY	129,50							
y875	MOOV MOKA	129,50							

Addebito cassa (prezzo netto) / Crate charge (net price) / Palette supplémentaire (prix net) / Aufreispalette (Nettopreis) - € 140
 Addebito cavalletto 18pz (prezzo netto) / Extra rack 18pcs (net price) / Chevalet supplémentaire 18pcs (prix net) / Aufpreisgestell 18St (Nettopreis) - € 270

120x120 (48"x48") (119,5x119,5)* - 9 mm - Rettificato

● Natural R9

y854	MOOV ANTHRACITE	101,80	MQ	2	2,86	60,80	57,12	1.251,00	20
y852	MOOV BEIGE	96,30							
y853	MOOV GREY	96,30							
y851	MOOV IVORY	101,80							
y855	MOOV MOKA	101,80							

■ Grip R10

8Y54	MOOV ANTHRACITE	101,80							
8Y52	MOOV BEIGE	96,30							
8Y53	MOOV GREY	96,30							
8Y51	MOOV IVORY	101,80							
8Y55	MOOV MOKA	101,80							

MOOV

Size	Code	Colour	Euro	U.M.	Pcs / Box	Mq / Box	Kg / Box	Mq / Pallet	Kg / Pallet	Box / Pallet
------	------	--------	------	------	--------------	-------------	-------------	----------------	----------------	-----------------

MOOV

EFFETTO CEMENTO - CONCRETE EFFECT - EFFET CIMENT - ZEMENT EFFEKT

60x120 (24"x48") - 9 mm - Rettificato

● Natural R9

Y874	MOOV ANTHRACITE	85,10	MQ	2	1,44	31,93	50,40	1.138,00	35
Y872	MOOV BEIGE	81,90							
Y873	MOOV GREY	81,90							
Y871	MOOV IVORY	85,10							
Y875	MOOV MOKA	85,10							

■ Grip R10

8Y74	MOOV ANTHRACITE	85,10							
8Y72	MOOV BEIGE	81,90							
8Y73	MOOV GREY	81,90							
8Y71	MOOV IVORY	85,10							
8Y75	MOOV MOKA	85,10							

▲ Grip R11

8Y84	MOOV ANTHRACITE	85,10							
8Y82	MOOV BEIGE	83,50							
8Y83	MOOV GREY	83,50							
8Y81	MOOV IVORY	85,10							
8Y85	MOOV MOKA	85,10							

MOOV

Size	Code	Colour	Euro	U.M.	Pcs / Box	Mq / Box	Kg / Box	Mq / Pallet	Kg / Pallet	Box / Pallet
------	------	--------	------	------	--------------	-------------	-------------	----------------	----------------	-----------------

MOOV

EFFETTO CEMENTO - CONCRETE EFFECT - EFFET CIMENT - ZEMENT EFFEKT

60x60 (24"x24") - 9 mm - Rettificato

● Natural R9

Y804	MOOV ANTHRACITE	62,10	MQ	3	1,08	21,00	43,20	853,00	40
Y802	MOOV BEIGE	59,90							
Y803	MOOV GREY	59,90							
Y801	MOOV IVORY	62,10							
Y805	MOOV MOKA	62,10							

■ Grip R10

8Y04	MOOV ANTHRACITE	62,10							
8Y02	MOOV BEIGE	59,90							
03Y8	MOOV GREY	59,90							
01Y8	MOOV IVORY	62,10							
8Y05	MOOV MOKA	62,10							

▲ Grip R11

8Y14	MOOV ANTHRACITE	63,40							
8Y12	MOOV BEIGE	61,20							
8Y03	MOOV GREY	61,20							
11Y8	MOOV IVORY	63,40							
8Y15	MOOV MOKA	63,40							



MOOV

Size	Code	Colour	Euro	U.M.	Pcs / Box	Mq / Box	Kg / Box	Mq / Pallet	Kg / Pallet	Box / Pallet
------	------	--------	------	------	-----------	----------	----------	-------------	-------------	--------------

MOOV

EFFETTO CEMENTO - CONCRETE EFFECT - EFFET CIMENT - ZEMENT EFFEKT

30x60 (12"x24") - 9 mm - Rettificato

● Natural R9

Y84D	MOOV ANTHRACITE	51,60	MQ	7	1,26	25,00	50,40	1.016,00	40
Y82D	MOOV BEIGE	49,70							
Y83D	MOOV GREY	49,70							
Y81D	MOOV IVORY	51,60							
Y85D	MOOV MOKA	51,60							

■ Grip R10

Y84I	MOOV ANTHRACITE	51,60							
Y82I	MOOV BEIGE	49,70							
Y83I	MOOV GREY	49,70							
Y81I	MOOV IVORY	51,60							
Y85I	MOOV MOKA	51,60							

▲ Grip R11

Y84K	MOOV ANTHRACITE	52,80							
Y82K	MOOV BEIGE	51,10							
Y83K	MOOV GREY	51,10							
Y81K	MOOV IVORY	52,80							
Y85K	MOOV MOKA	52,80							

MOOV

14,7x60 (5,79"x24") - 9 mm - Rettificato

● Natural R9

Y814	MOOV ANTHRACITE	78,20	MQ	12	1,06	23,86	31,75	731,80	30
Y812	MOOV BEIGE	75,50							
Y813	MOOV GREY	75,50							
Y811	MOOV IVORY	78,20							
Y815	MOOV MOKA	78,20							

9,7x60 (3.80"x24") - 9 mm - Rettificato

● Natural R9

Y8n4	MOOV ANTHRACITE	84,80	MQ	10	0,58	12,75	34,92	781,00	60
Y8n2	MOOV BEIGE	81,80							
Y8n3	MOOV GREY	81,80							
Y8n1	MOOV IVORY	84,80							
Y8n5	MOOV MOKA	84,80							

Size	Code	Colour	Euro	U.M.	Pcs / Box	Mq / Box	Kg / Box	Mq / Pallet	Kg / Pallet	Box / Pallet
------	------	--------	------	------	-----------	----------	----------	-------------	-------------	--------------

MOOV

EFFETTO CEMENTO - CONCRETE EFFECT - EFFET CIMENT - ZEMENT EFFEKT

6,4x60 (2.52"x24") - 9 mm - Rettificato

● Natural R9

Y824	MOOV ANTHRACITE	90,00	MQ	15	0,58	12,48	32,26	714,88	56
Y822	MOOV BEIGE	86,90							
Y823	MOOV GREY	86,90							
Y821	MOOV IVORY	90,00							
Y825	MOOV MOKA	90,00							

3,1x60 (1.20"x24") - 9 mm - Rettificato

● Natural R9

Y8p4	MOOV ANTHRACITE	116,70	MQ	30	0,56	13,00	31,25	744,00	56
Y8p2	MOOV BEIGE	112,80							
Y8p3	MOOV GREY	112,80							
Y8p1	MOOV IVORY	116,70							
Y8p5	MOOV MOKA	116,70							

120x120 (48"x48") - 20 mm - Rettificato

▲ Grip R11

Y58Y	MOOV ANTHRACITE	146,20	MQ	1	1,43	67,10	28,56	1.377,00	20
Y85Y	MOOV GREY	138,90							
Y86Y	MOOV MOKA	146,20							

90x90 (36"x36") - 20 mm - Rettificato

▲ Grip R11

W5Y8	MOOV ANTHRACITE	130,50	MQ	1	0,81	38,00	14,58	699,00	18
W2Y8	MOOV BEIGE	127,70							
W3Y8	MOOV GREY	127,70							
W4Y8	MOOV MOKA	130,50							

MOOV

Size	Code	Colour	Euro	U.M.	Pcs / Box	Mq / Box	Kg / Box	Mq / Pallet	Kg / Pallet	Box / Pallet
------	------	--------	------	------	-----------	----------	----------	-------------	-------------	--------------

MOOV

EFFETTO CEMENTO - CONCRETE EFFECT - EFFET CIMENT - ZEMENT EFFEKT

60x60 (24"x24") - 20 mm - Rettificato

▲ Grip R11

Y8W5	MOOV ANTHRACITE	97,20	MQ	2	0,72	30,70	21,60	934,00	30
Y8W2	MOOV BEIGE	94,70							
Y8W3	MOOV GREY	94,70							
Y8W5	MOOV MOKA	97,20							

30x60 (12"x24") Decoro Docks - 9 mm - Rettificato

● Natural R9

Y84M	MOOV ANTHRACITE	24,70	PZ	5	0,90	17,50	35,10	695,50	39
Y82M	MOOV BEIGE	24,70							
Y83M	MOOV GREY	24,70							
Y81M	MOOV IVORY	24,70							
Y85M	MOOV MOKA	24,70							

Venduti solo a scatole complete / Only full boxes sold /
Vendus par boite complete / Nur volle Karton

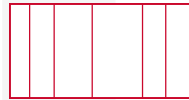

30x60 (12"x24") Strips - 9 mm - Rettificato

● Natural R9

Y8T5	MOOV ANTHRACITE	31,80	PZ	4	0,72	16,04	21,60	494,20	30
Y8T2	MOOV BEIGE	31,80							
Y8T4	MOOV GREY	31,80							
Y8T1	MOOV IVORY	31,80							
Y8T3	MOOV MOKA	31,80							

Venduti solo a scatole complete / Only full boxes sold /
Vendus par boite complete / Nur volle Karton



9,7x60 (3.80"x24") Listello Up - 9 mm - Rettificato

● Natural R9

Y8U4	MOOV ANTHRACITE	120,00	MQ	8	0,47	10,48	27,96	641,80	60
Y8U2	MOOV BEIGE	116,60							
Y8U3	MOOV GREY	116,60							
Y8U1	MOOV IVORY	120,00							
Y8U5	MOOV MOKA	120,00							

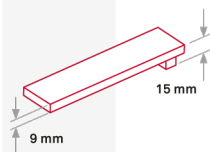

MOOV

Size	Code	Colour	Euro	U.M.	Pcs / Box	Mq / Box	Kg / Box	Mq / Pallet	Kg / Pallet	Box / Pallet
------	------	--------	------	------	-----------	----------	----------	-------------	-------------	--------------

MOOV

EFFETTO CEMENTO - CONCRETE EFFECT - EFFET CIMENT - ZEMENT EFFEKT

6,4x60 (2.52"x24") Listello Up - 9 mm - Rettificato

● Natural R9

Y8o4	MOOV ANTHRACITE	126,30	MQ	12	0,46	10,50	25,80	601,00	56
Y8o2	MOOV BEIGE	122,30							
Y8o3	MOOV GREY	122,30							
Y8o1	MOOV IVORY	126,30							
Y8o5	MOOV MOKA	126,30							

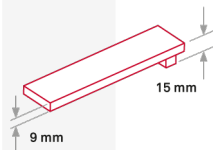

30x30 (12"x12") Mosaico T100 (2,8x2,8) - 9 mm - Rettificato

● Natural R9

Y8M5	MOOV ANTHRACITE	27,20	PZ	6	0,54	11,20	25,00	550,60	48
Y8M2	MOOV BEIGE	27,20							
Y8M4	MOOV GREY	27,20							
Y8M1	MOOV IVORY	27,20							
Y8M3	MOOV MOKA	27,20							

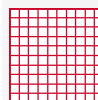

Venduti solo a scatole complete / Only full boxes sold /
Vendus par boite complete / Nur volle Karton

33x120x4 (13"x48") Scalino incollato - 9 mm - Rettificato

● Natural R9

y8s4	MOOV ANTHRACITE	235,10	PZ	2	0,79	18,40	19,01	454,60	24
y8s2	MOOV BEIGE	235,10							
y8s3	MOOV GREY	235,10							
y8s1	MOOV IVORY	235,10							
y8s5	MOOV MOKA	235,10							

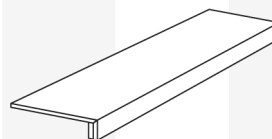

Lavorato su richiesta e venduto solo a scatole complete / Manufactured upon request
and only full boxes sold / Seulement à la demande et vendus par boite complete / Nur
auf Anfrage und nur volle Karton

MOOV

Size	Code	Colour	Euro	U.M.	Pcs / Box	Mq / Box	Kg / Box	Mq / Pallet	Kg / Pallet	Box / Pallet
------	------	--------	------	------	-----------	----------	----------	-------------	-------------	--------------

MOOV

EFFETTO CEMENTO - CONCRETE EFFECT - EFFET CIMENT - ZEMENT EFFEKT

33x120x4 (13"x48") Scalino angolare incollato - 9 mm - Rettificato

● Natural R9

y8d4	MOOV ANTHRACITE ANG. DX	258,50	PZ	1	0,40	9,00	9,50	238,60	24
y8S4	MOOV ANTHRACITE ANG. SX	258,50							
y8d2	MOOV BEIGE ANG. DX	258,50							
y8S2	MOOV BEIGE ANG. SX	258,50							
y8d3	MOOV GREY ANG. DX	258,50							
y8S3	MOOV GREY ANG. SX	258,50							
y8d1	MOOV IVORY ANG. DX	258,50							
y8S1	MOOV IVORY ANG. SX	258,50							
y8d5	MOOV MOKA ANG. DX	258,50							
y8S5	MOOV MOKA ANG. SX	258,50							

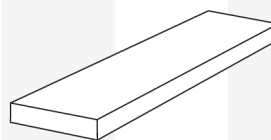

Lavorato su richiesta e venduto solo a scatole complete / Manufactured upon request and only full boxes sold / Seulement à la demande et vendus par boîte complete / Nur auf Anfrage und nur volle Karton

33x60x4 (13"x24") Scalino incollato - 9 mm - Rettificato

● Natural R9

Y8S5	MOOV ANTHRACITE	113,20	PZ	4	0,79	21,70	19,01	533,80	24
Y8S2	MOOV BEIGE	113,20							
Y8S4	MOOV GREY	113,20							
Y8S1	MOOV IVORY	113,20							
Y8S3	MOOV MOKA	113,20							

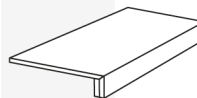

Lavorato su richiesta e venduto solo a scatole complete / Manufactured upon request and only full boxes sold / Seulement à la demande et vendus par boîte complete / Nur auf Anfrage und nur volle Karton

33x33x4 (13"x13") Scalino angolare incollato - 9 mm - Rettificato

● Natural R9

Y8A5	MOOV ANTHRACITE	138,30	PZ	4	0,44	14,48	13,07	447,40	30
Y8A2	MOOV BEIGE	138,30							
Y8A4	MOOV GREY	138,30							
Y8A1	MOOV IVORY	138,30							
Y8A3	MOOV MOKA	138,30							



Lavorato su richiesta e venduto solo a scatole complete / Manufactured upon request and only full boxes sold / Seulement à la demande et vendus par boîte complete / Nur auf Anfrage und nur volle Karton

15x30x4 Terminale L incollato - 9 mm - Rettificato

● Natural R9

Y8E4	MOOV ANTHRACITE	34,00	PZ	10	0,45	14,90	14,40	489,80	32
Y8E2	MOOV BEIGE	34,00							
Y8E3	MOOV GREY	34,00							
Y8E1	MOOV IVORY	34,00							
Y8E5	MOOV MOKA	34,00							

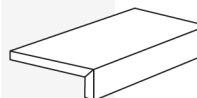

Lavorato su richiesta e venduto solo a scatole complete / Manufactured upon request and only full boxes sold / Seulement à la demande et vendus par boîte complete / Nur auf Anfrage und nur volle Karton

Size	Code	Colour	Euro	U.M.	Pcs / Box	Mq / Box	Kg / Box	Mq / Pallet	Kg / Pallet	Box / Pallet
------	------	--------	------	------	-----------	----------	----------	-------------	-------------	--------------

MOOV

EFFETTO CEMENTO - CONCRETE EFFECT - EFFET CIMENT - ZEMENT EFFEKT

4,6x120 (1.80"x48") Battiscopa - 9 mm - Rettificato

● Natural R9

					Mt				
Y85R	MOOV ANTHRACITE	24,70	PZ	6	7,20	7,80	345,60	387,40	48
Y82R	MOOV BEIGE	24,70					Venduti solo a scatole complete / Only full boxes sold / Vendus par boîte complete / Nur volle Karton		
Y84R	MOOV GREY	24,70							
Y81R	MOOV IVORY	24,70							
Y83R	MOOV MOKA	24,70							



7,2x60 (2.80"x24") Battiscopa - 9 mm - Rettificato

● Natural R9

					Mt				
Y8R5	MOOV ANTHRACITE	11,70	PZ	10	6,00	10,48	480,00	851,40	80
Y8R2	MOOV BEIGE	11,70					Venduti solo a scatole complete / Only full boxes sold / Vendus par boîte complete / Nur volle Karton		
Y8R4	MOOV GREY	11,70							
Y8R1	MOOV IVORY	11,70							
Y8R3	MOOV MOKA	11,70							

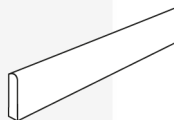

MOOV

Size	Code	Colour	Euro	U.M.	Pcs / Box	Mq / Box	Kg / Box	Mq / Pallet	Kg / Pallet	Box / Pallet
------	------	--------	------	------	--------------	-------------	-------------	----------------	----------------	-----------------

NOORD

EFFETTO CEMENTO - CONCRETE EFFECT - EFFET CIMENT - ZEMENT EFFEKT

120x120 (48"x48") (119,5x119,5)* - 9 mm - Rettificato

■ Natural R10

EDC6	NOORD ANTHRACITE	98,50	MQ	2	2,86	60,80	57,12	1.251,00	20
EDC3	NOORD GOLD	98,50							
EDC1	NOORD GREY	103,70							
EDC7	NOORD IVORY	103,70							
EDC8	NOORD SILVER	98,50							
EDC2	NOORD TAUPE	103,70							
EDC5	NOORD WHITE	103,70							

60x120 (24"x48") - 9 mm - Rettificato

■ Natural R10

EDD4	NOORD ANTHRACITE	83,50	MQ	2	1,44	31,93	50,40	1.138,00	35
EDD3	NOORD GOLD	83,50							
EDD1	NOORD GREY	86,90							
EDD7	NOORD IVORY	86,90							
EDD8	NOORD SILVER	83,50							
EDD2	NOORD TAUPE	86,90							
EDD5	NOORD WHITE	86,90							

80x80 (32"x32") - 9 mm - Rettificato

■ Natural R10

EDG4	NOORD ANTHRACITE	73,90	MQ	2	1,28	25,60	61,44	1.253,80	48
EDG3	NOORD GOLD	73,90							
EDG1	NOORD GREY	77,00							
EDG7	NOORD IVORY	77,00							
EDG8	NOORD SILVER	73,90							
EDG2	NOORD TAUPE	77,00							
EDG5	NOORD WHITE	77,00							

NOORD

Size	Code	Colour	Euro	U.M.	Pcs / Box	Mq / Box	Kg / Box	Mq / Pallet	Kg / Pallet	Box / Pallet
------	------	--------	------	------	-----------	----------	----------	-------------	-------------	--------------

NOORD

EFFETTO CEMENTO - CONCRETE EFFECT - EFFET CIMENT - ZEMENT EFFEKT

60x60 (24"x24") - 9 mm - Rettificato

■ Natural R10

EDH4	NOORD ANTHRACITE	61,70	MQ	3	1,08	21,00	43,20	853,00	40
EDH3	NOORD GOLD	61,70							
EDH1	NOORD GREY	64,30							
EDH7	NOORD IVORY	64,30							
EDH8	NOORD SILVER	61,70							
EDH2	NOORD TAUPE	64,30							
EDH5	NOORD WHITE	64,30							

30x60 (12"x24") - 9 mm - Rettificato

■ Natural R10

EDI4	NOORD ANTHRACITE	51,40	MQ	7	1,26	25,00	50,40	1.016,00	40
EDI3	NOORD GOLD	51,40							
EDI1	NOORD GREY	53,40							
EDI7	NOORD IVORY	53,40							
EDI8	NOORD SILVER	51,40							
EDI2	NOORD TAUPE	53,40							
EDI5	NOORD WHITE	53,40							

9,7x60 (3.80"x24") - 9 mm - Rettificato

■ Natural R10

EDO4	NOORD ANTHRACITE	83,60	MQ	10	0,58	12,75	34,92	781,00	60
EDO3	NOORD GOLD	83,60							
EDO1	NOORD GREY	87,10							
EDO7	NOORD IVORY	87,10							
EDO8	NOORD SILVER	83,60							
EDO2	NOORD TAUPE	87,10							
EDO5	NOORD WHITE	87,10							

120x120 (48"x48") - 20 mm - Rettificato

▲ Grip R11

1YED	NOORD GREY	140,20	MQ	1	1,43	67,10	28,56	1.377,00	20
5YED	NOORD WHITE	140,20							

NOORD

Size	Code	Colour	Euro	U.M.	Pcs / Box	Mq / Box	Kg / Box	Mq / Pallet	Kg / Pallet	Box / Pallet
------	------	--------	------	------	-----------	----------	----------	-------------	-------------	--------------

NOORD

EFFETTO CEMENTO - CONCRETE EFFECT - EFFET CIMENT - ZEMENT EFFEKT

80x80 (32"x32") - 20 mm - Rettificato

▲ Grip R11

EDW4	NOORD ANTHRACITE	114,90	MQ	1	0,64	28,00	26,88	1.272,40	42
EDW1	NOORD GREY	117,50							
EDW5	NOORD WHITE	117,50							



60x60 (24"x24") - 20 mm - Rettificato

▲ Grip R11

4HED	NOORD ANTHRACITE	93,80	MQ	2	0,72	30,70	21,60	934,00	30
3HED	NOORD GOLD	93,80							
1HED	NOORD GREY	95,80							
7HED	NOORD IVORY	95,80							
5HED	NOORD WHITE	95,80							



30x60 (12"x24") Decoro Docks - 9 mm - Rettificato

● Natural R10

ED4M	NOORD ANTHRACITE	24,70	PZ	5	0,90	17,50	35,10	695,50	39
ED3M	NOORD GOLD	24,70							
ED1M	NOORD GREY	24,70							
ED7M	NOORD IVORY	24,70							
ED8M	NOORD SILVER	24,70							
ED2M	NOORD TAUPE	24,70							
ED5M	NOORD WHITE	24,70							

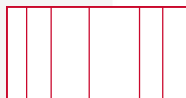

Venduti solo a scatole complete / Only full boxes sold /
Vendus par boite complete / Nur volle Karton

9,7x60 (3.80"x24") Listello Up - 9 mm - Rettificato

● Natural R10

EDU4	NOORD ANTHRACITE	115,90	MQ	8	0,47	10,48	27,96	641,80	60
EDU3	NOORD GOLD	115,90							
EDU1	NOORD GREY	120,40							
EDU7	NOORD IVORY	120,40							
EDU8	NOORD SILVER	115,90							
EDU2	NOORD TAUPE	120,40							
EDU5	NOORD WHITE	120,40							

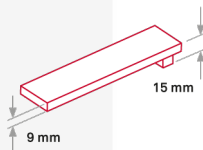

NOORD

Size	Code	Colour	Euro	U.M.	Pcs / Box	Mq / Box	Kg / Box	Mq / Pallet	Kg / Pallet	Box / Pallet
------	------	--------	------	------	-----------	----------	----------	-------------	-------------	--------------

NOORD

EFFETTO CEMENTO - CONCRETE EFFECT - EFFET CIMENT - ZEMENT EFFEKT

30x30 (12"x12") Mosaico T36 (4,8x4,8) - 9 mm - Rettificato

■ Natural R10

EDM4	NOORD ANTHRACITE	14,00	PZ	10	0,90	17,00	27,00	523,00	30
EDM3	NOORD GOLD	14,00							
EDM1	NOORD GREY	14,00							
EDM7	NOORD IVORY	14,00							
EDM8	NOORD SILVER	14,00							
EDM2	NOORD TAUPE	14,00							
EDM5	NOORD WHITE	14,00							

Venduti solo a scatole complete / Only full boxes sold /
Vendus par boîte complete / Nur volle Karton



999x999 Piatto doccia filo pavimento - Non rettificato

■ Natural R10

NWPI	NOORD WHITE		PZ	1	1,08			0,00	1
PINW	NOORD WHITE								

33x120x4 (13"x48") Scalino incollato - 9 mm - Rettificato

■ Natural R10

EDQ4	NOORD ANTHRACITE	235,10	PZ	2	0,79	18,40	19,01	454,60	24
EDQ3	NOORD GOLD	235,10							
EDQ1	NOORD GREY	235,10							
EDQ7	NOORD IVORY	235,10							
EDQ8	NOORD SILVER	235,10							
EDQ2	NOORD TAUPE	235,10							
EDQ5	NOORD WHITE	235,10							

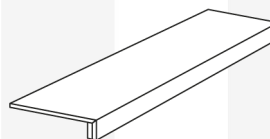

Lavorato su richiesta e venduto solo a scatole complete / Manufactured upon request
and only full boxes sold / Seulement à la demande et vendus par boîte complete / Nur
auf Anfrage und nur volle Karton

NOORD

Size	Code	Colour	Euro	U.M.	Pcs / Box	Mq / Box	Kg / Box	Mq / Pallet	Kg / Pallet	Box / Pallet
------	------	--------	------	------	-----------	----------	----------	-------------	-------------	--------------

NOORD

EFFETTO CEMENTO - CONCRETE EFFECT - EFFET CIMENT - ZEMENT EFFEKT

33x120x4 (13"x48") Scalino angolare incollato - 9 mm - Rettificato

■ Natural R10

EDX4	NOORD ANTHRACITE ANG. DX	258,50	PZ	1	0,40	9,00	9,50	238,60	24
EDY4	NOORD ANTHRACITE ANG. SX	258,50							
EDX3	NOORD GOLD ANG. DX	258,50							
EDY3	NOORD GOLD ANG. SX	258,50							
EDX1	NOORD GREY ANG. DX	258,50							
EDY1	NOORD GREY ANG. SX	258,50							
EDX7	NOORD IVORY ANG. DX	258,50							
EDY7	NOORD IVORY ANG. SX	258,50							
EDX8	NOORD SILVER ANG. DX	258,50							
EDY8	NOORD SILVER ANG. SX	258,50							
EDX2	NOORD TAUPE ANG. DX	258,50							
EDY2	NOORD TAUPE ANG. SX	258,50							
EDX5	NOORD WHITE ANG. DX	258,50							
EDY5	NOORD WHITE ANG. SX	258,50							

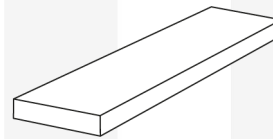

Lavorato su richiesta e venduto solo a scatole complete / Manufactured upon request and only full boxes sold / Seulement à la demande et vendus par boîte complete / Nur auf Anfrage und nur volle Karton

33x60x4 (13"x24") Scalino incollato - 9 mm - Rettificato

■ Natural R10

EDS4	NOORD ANTHRACITE	113,20	PZ	4	0,79	21,70	19,01	533,80	24
EDS3	NOORD GOLD	113,20							
EDS1	NOORD GREY	113,20							
EDS7	NOORD IVORY	113,20							
EDS8	NOORD SILVER	113,20							
EDS2	NOORD TAUPE	113,20							
EDS5	NOORD WHITE	113,20							

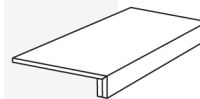

Lavorato su richiesta e venduto solo a scatole complete / Manufactured upon request and only full boxes sold / Seulement à la demande et vendus par boîte complete / Nur auf Anfrage und nur volle Karton

33x33x4 (13"x13") Scalino angolare incollato - 9 mm - Rettificato

■ Natural R10

EDV4	NOORD ANTHRACITE	138,30	PZ	4	0,44	14,48	13,07	447,40	30
EDV3	NOORD GOLD	138,30							
EDV1	NOORD GREY	138,30							
EDV7	NOORD IVORY	138,30							
EDV8	NOORD SILVER	138,30							
EDV2	NOORD TAUPE	138,30							
EDV5	NOORD WHITE	138,30							



Lavorato su richiesta e venduto solo a scatole complete / Manufactured upon request and only full boxes sold / Seulement à la demande et vendus par boîte complete / Nur auf Anfrage und nur volle Karton

NOORD

Size	Code	Colour	Euro	U.M.	Pcs / Box	Mq / Box	Kg / Box	Mq / Pallet	Kg / Pallet	Box / Pallet
------	------	--------	------	------	-----------	----------	----------	-------------	-------------	--------------

NOORD

EFFETTO CEMENTO - CONCRETE EFFECT - EFFET CIMENT - ZEMENT EFFEKT

4,6x120 (1.80"x48") Battiscopa - 9 mm - Rettificato

				Mt						
EDR4	NOORD ANTHRACITE		24,70	PZ	6	7,20	7,80	345,60	387,40	48
EDR3	NOORD GOLD		24,70		Venduti solo a scatole complete / Only full boxes sold / Vendus par boite complete / Nur volle Karton					
EDR1	NOORD GREY		24,70							
EDR7	NOORD IVORY		24,70							
EDR8	NOORD SILVER		24,70							
EDR2	NOORD TAUPE		24,70							
EDR5	NOORD WHITE		24,70							



7x80 (2.75"x32") Battiscopa - 9 mm - Rettificato

				Mt						
ED4B	NOORD ANTHRACITE		13,30	PZ	8	6,40	9,30	460,80	682,60	72
ED3B	NOORD GOLD		13,30		Venduti solo a scatole complete / Only full boxes sold / Vendus par boite complete / Nur volle Karton					
ED1B	NOORD GREY		13,30							
ED7B	NOORD IVORY		13,30							
ED8B	NOORD SILVER		13,30							
ED2B	NOORD TAUPE		13,30							
ED5B	NOORD WHITE		13,30							



7,2x60 (2.80"x24") Battiscopa - 9 mm - Rettificato

				Mt						
ED4R	NOORD ANTHRACITE		11,70	PZ	10	6,00	10,48	480,00	851,40	80
ED3R	NOORD GOLD		11,70		Venduti solo a scatole complete / Only full boxes sold / Vendus par boite complete / Nur volle Karton					
ED1R	NOORD GREY		11,70							
ED7R	NOORD IVORY		11,70							
ED8R	NOORD SILVER		11,70							
ED2R	NOORD TAUPE		11,70							
ED5R	NOORD WHITE		11,70							

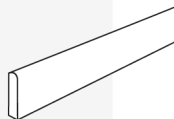

NOORD

Size	Code	Colour	Euro	U.M.	Pcs / Box	Mq / Box	Kg / Box	Mq / Pallet	Kg / Pallet	Box / Pallet
------	------	--------	------	------	--------------	-------------	-------------	----------------	----------------	-----------------

OMNIA

EFFETTO PIETRA - STONE EFFECT - EFFET PIERRE - STEIN EFFEKT

120x240 (48"x96") (119,5x239)* - 9 mm - Rettificato

□ Spazzolato R10

GK4A	OMNIA CEPPO GREY	123,80	MQ	1	2,86	61,60	51,41	1.203,80	18
GK7A	OMNIA TIVOLI IVORY	130,50							

Addebito cassa (prezzo netto) / Crate charge (net price) / Palette supplémentaire (prix net) / Aufpreispalette (Nettopreis) - € 140
 Addebito cavalletto 18pz (prezzo netto) / Extra rack 18pcs (net price) / Chevalet supplémentaire 18pcs (prix net) / Aufpreisgestell 18St (Nettopreis) - € 270

120x120 (48"x48") (119,5x119,5)* - 9 mm - Rettificato

□ Spazzolato R10

GK4C	OMNIA CEPPO GREY	97,40	MQ	2	2,86	60,80	57,12	1.251,00	20
GK5C	OMNIA DEVIX GREIGE	97,40							
GK1C	OMNIA EMPERADOR WHITE	102,30							
GK6C	OMNIA RAPOLANO BEIGE	102,30							
GK2C	OMNIA VENEZIA IVORY	102,30							

OMNIA

60x120 (24"x48") - 9 mm - Rettificato

□ Spazzolato R10

GK4D	OMNIA CEPPO GREY	82,10	MQ	2	1,44	31,93	50,40	1.138,00	35
GK5D	OMNIA DEVIX GREIGE	82,10							
GK1D	OMNIA EMPERADOR WHITE	86,30							
GK6D	OMNIA RAPOLANO BEIGE	86,30							
GK8D	OMNIA ROMANO SAND	86,30							
GK7D	OMNIA TIVOLI IVORY	86,30							
GK2D	OMNIA VENEZIA IVORY	86,30							

Size	Code	Colour	Euro	U.M.	Pcs / Box	Mq / Box	Kg / Box	Mq / Pallet	Kg / Pallet	Box / Pallet
------	------	--------	------	------	--------------	-------------	-------------	----------------	----------------	-----------------

OMNIA

EFFETTO PIETRA - STONE EFFECT - EFFET PIERRE - STEIN EFFEKT

80x80 (32"x32") - 9 mm - Rettificato

□ Spazzolato R10

GK4G	OMNIA CEPPO GREY	73,00	MQ	2	1,28	25,60	61,44	1.253,80	48
GK5G	OMNIA DEVIX GREIGE	73,00							
GK1G	OMNIA EMPERADOR WHITE	76,80							
GK6G	OMNIA RAPOLANO BEIGE	76,80							
GK8G	OMNIA ROMANO SAND	76,80							
GK7G	OMNIA TIVOLI IVORY	76,80							
GK2G	OMNIA VENEZIA IVORY	76,80							

40x80 (16"x32") - 9 mm - Rettificato

□ Spazzolato R10

GK4I	OMNIA CEPPO GREY	59,30	MQ	4	1,28	27,36	35,84	791,08	28
GK5I	OMNIA DEVIX GREIGE	59,30							
GK1I	OMNIA EMPERADOR WHITE	61,90							
GK6I	OMNIA RAPOLANO BEIGE	61,90							
GK8I	OMNIA ROMANO SAND	61,90							
GK7I	OMNIA TIVOLI IVORY	61,90							
GK2I	OMNIA VENEZIA IVORY	61,90							

60x120 (24"x48") - 20 mm - Rettificato

▲ Structured R11

GKW4	OMNIA CEPPO GREY	116,80	MQ	1	0,72	33,75	25,20	1.202,25	35
GKW5	OMNIA DEVIX GREIGE	116,80							
GKW1	OMNIA EMPERADOR WHITE	121,70							
GKW6	OMNIA RAPOLANO BEIGE	121,70							
GKW8	OMNIA ROMANO SAND	121,70							
GKW7	OMNIA TIVOLI IVORY	121,70							
GKW2	OMNIA VENEZIA IVORY	121,70							

OMNIA

Size	Code	Colour	Euro	U.M.	Pcs / Box	Mq / Box	Kg / Box	Mq / Pallet	Kg / Pallet	Box / Pallet
------	------	--------	------	------	-----------	----------	----------	-------------	-------------	--------------

OMNIA

EFFETTO PIETRA - STONE EFFECT - EFFET PIERRE - STEIN EFFEKT

60x120 (24"x48") Decoro Crossing 3D - 9 mm - Rettificato

■ 3D

GK4B	OMNIA CEPPO GREY	88,00	MQ	2	1,44	31,93	50,40	1.139,00	35
GK5B	OMNIA DEVIX GREIGE	88,00							
GK1B	OMNIA EMPERADOR WHITE	92,40							
GK6B	OMNIA RAPOLANO BEIGE	92,40							
GK8B	OMNIA ROMANO SAND	92,40							
GK7B	OMNIA TIVOLI IVORY	92,40							
GK2B	OMNIA VENEZIA IVORY	92,40							

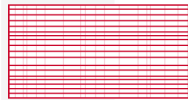

30x30 (12"x12") Mosaico T36 (4,8x4,8) - 9 mm - Rettificato

□ Spazzolato R10

GKM4	OMNIA CEPPO GREY	14,00	PZ	10	0,90	17,00	27,00	523,00	30
GKM5	OMNIA DEVIX GREIGE	14,00							
GKM1	OMNIA EMPERADOR WHITE	14,00							
GKM6	OMNIA RAPOLANO BEIGE	14,00							
GKM8	OMNIA ROMANO SAND	14,00							
GKM7	OMNIA TIVOLI IVORY	14,00							
GKM2	OMNIA VENEZIA IVORY	14,00							



Venduti solo a scatole complete / Only full boxes sold /
Vendus par boite complete / Nur volle Karton

33x120x4 (13"x48") Scalino incollato - 9 mm - Rettificato

□ Spazzolato R10

GK4Q	OMNIA CEPPO GREY	235,10	PZ	2	0,79	18,40	19,01	454,60	24
GK5Q	OMNIA DEVIX GREIGE	235,10							
GK1Q	OMNIA EMPERADOR WHITE	235,10							
GK6Q	OMNIA RAPOLANO BEIGE	235,10							
GK8Q	OMNIA ROMANO SAND	235,10							
GK7Q	OMNIA TIVOLI IVORY	235,10							
GK2Q	OMNIA VENEZIA IVORY	235,10							

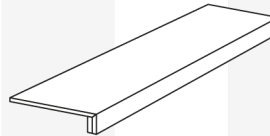

Lavorato su richiesta e venduto solo a scatole complete / Manufactured upon request
and only full boxes sold / Seulement à la demande et vendus par boite complete / Nur
auf Anfrage und nur volle Karton

Size	Code	Colour	Euro	U.M.	Pcs / Box	Mq / Box	Kg / Box	Mq / Pallet	Kg / Pallet	Box / Pallet
------	------	--------	------	------	-----------	----------	----------	-------------	-------------	--------------

OMNIA

EFFETTO PIETRA - STONE EFFECT - EFFET PIERRE - STEIN EFFEKT

33x120x4 (13"x48") Scalino angolare incollato - 9 mm - Rettificato

□ Spazzolato R10

GK4X	OMNIA CEPPO GREY ANG. DX	258,50	PZ	1	0,40	9,00	9,50	238,60	24
GK4Y	OMNIA CEPPO GREY ANG. SX	258,50							
GK5X	OMNIA DEVIX GREIGE ANG. DX	258,50							
GK5Y	OMNIA DEVIX GREIGE ANG. SX	258,50							
GK1X	OMNIA EMPERADOR WHITE ANG. DX	258,50							
GK1Y	OMNIA EMPERADOR WHITE ANG. SX	258,50							
GK6X	OMNIA RAPOLANO BEIGE ANG. DX	258,50							
GK6Y	OMNIA RAPOLANO BEIGE ANG. SX	258,50							
GK8X	OMNIA ROMANO SAND ANG. DX	258,50							
GK8Y	OMNIA ROMANO SAND ANG. SX	258,50							
GK7X	OMNIA TIVOLI IVORY ANG. DX	258,50							
GK7Y	OMNIA TIVOLI IVORY ANG. SX	258,50							
GK2X	OMNIA VENEZIA IVORY ANG. DX	258,50							
GK2Y	OMNIA VENEZIA IVORY ANG. SX	258,50							

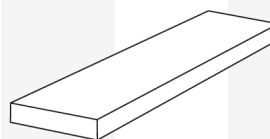

4,6x120 (1.80"x48") Battiscopa - 9 mm - Rettificato

□ Spazzolato R10

				Mt						
GK4R	OMNIA CEPPO GREY	24,70	PZ	6	7,20	7,80	345,60	387,40	48	
GK5R	OMNIA DEVIX GREIGE	24,70								
GK1R	OMNIA EMPERADOR WHITE	24,70								
GK6R	OMNIA RAPOLANO BEIGE	24,70								
GK8R	OMNIA ROMANO SAND	24,70								
GK7R	OMNIA TIVOLI IVORY	24,70								
GK2R	OMNIA VENEZIA IVORY	24,70								



7x80 (2.75"x32") Battiscopa - 9 mm - Rettificato

□ Spazzolato R10

				Mt						
R4GK	OMNIA CEPPO GREY	13,30	PZ	8	6,40	9,30	460,80	682,60	72	
R5GK	OMNIA DEVIX GREIGE	13,30								
R1GK	OMNIA EMPERADOR WHITE	13,30								
R6GK	OMNIA RAPOLANO BEIGE	13,30								
R8GK	OMNIA ROMANO SAND	13,30								
R7GK	OMNIA TIVOLI IVORY	13,30								
R2GK	OMNIA VENEZIA IVORY	13,30								



OMNIA

Size	Code	Colour	Euro	U.M.	Pcs / Box	Mq / Box	Kg / Box	Mq / Pallet	Kg / Pallet	Box / Pallet
------	------	--------	------	------	-----------	----------	----------	-------------	-------------	--------------

ONICE

EFFETTO MARMO - MARBLE EFFECT - EFFET MARBRE - MARMOR EFFEKT

120x278 (48"x110") (119,5x278)* - 6 mm - Rettificato

◆ Lappato

ISA3	ONICE HONEY	164,70	MQ	1	3,32	49,56	59,80	990,08	18
ISA1	ONICE MULTICOLOR	169,40							
ISA2	ONICE PEARL	164,70							

Addebito cassa leggera (max7pz) (prezzo netto) / Light crate charge (max7pz) (net price) / Débit de caisse (max7pz) (prix net) / Kasse belasten (max7pz) (Nettopreis) - € 100
 Addebito cassa (prezzo netto) / Crate charge (net price) / Palette supplémentaire (prix net) / Aufreispalette (Nettopreis) - € 160
 Addebito cavalletto 18pz (prezzo netto) / Extra rack 18pcs (net price) / Chevalet supplémentaire 18pcs (prix net) / Aufpreisgestell 18St (Nettopreis) - € 270
 Addebito cavalletto 42pz (prezzo netto) / Extra rack 42pcs (net price) / Chevalet supplémentaire 42pcs (prix net) / Aufpreisgestell 42St (Nettopreis) - € 270

120x120 (48"x48") (119,5x119,5)* - 9 mm - Rettificato

◆ Lappato

ISC3	ONICE HONEY	142,80	MQ	2	2,86	60,80	57,12	1.251,00	20
ISC1	ONICE MULTICOLOR	147,00							
ISC2	ONICE PEARL	142,80							

60x120 (24"x48") - 9 mm - Rettificato

◆ Lappato

ISD3	ONICE HONEY	110,80	MQ	2	1,44	31,93	50,40	1.138,00	35
ISD1	ONICE MULTICOLOR	114,50							
ISD2	ONICE PEARL	110,80							

60x60 (24"x24") - 9 mm - Rettificato

◆ Lappato

ISH3	ONICE HONEY	102,40	MQ	3	1,08	21,00	43,20	853,00	40
ISH1	ONICE MULTICOLOR	105,60							
ISH2	ONICE PEARL	102,40							

30x30 (12"x12") Mosaico T100 (2,8x2,8) - 9 mm - Rettificato

◆ Lappato

ISM3	ONICE HONEY	32,90	PZ	6	0,54	11,20	25,00	550,60	48
ISM1	ONICE MULTICOLOR	32,90							
ISM2	ONICE PEARL	32,90							

Venduti solo a scatole complete / Only full boxes sold /
 Vendus par boîte complete / Nur volle Karton



ONICE

Size	Code	Colour	Euro	U.M.	Pcs / Box	Mq / Box	Kg / Box	Mq / Pallet	Kg / Pallet	Box / Pallet
------	------	--------	------	------	-----------	----------	----------	-------------	-------------	--------------

ONICE

EFFETTO MARMO - MARBLE EFFECT - EFFET MARBRE - MARMOR EFFEKT

33x120x4 (13"x48") Scalino incollato - 9 mm - Rettificato

◆ Lappato

ISS3	ONICE HONEY	268,50	PZ	2	0,79	18,40	19,01	454,60	24
ISS1	ONICE MULTICOLOR	268,50							
ISS2	ONICE PEARL	268,50							

Lavorato su richiesta e venduto solo a scatole complete / Manufactured upon request and only full boxes sold / Seulement à la demande et vendus par boîte complete / Nur auf Anfrage und nur volle Karton

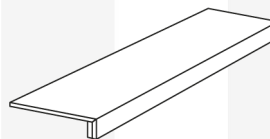

33x120x4 (13"x48") Scalino angolare incollato - 9 mm - Rettificato

◆ Lappato

ISF3	ONICE HONEY ANG. DX	295,30	PZ	1	0,40	9,00	9,50	238,60	24
ISG3	ONICE HONEY ANG. SX	295,30							
ISF1	ONICE MULTICOLOR ANG. DX	295,30							
ISG1	ONICE MULTICOLOR ANG. SX	295,30							
ISF2	ONICE PEARL ANG. DX	295,30							
ISG2	ONICE PEARL ANG. SX	295,30							

Lavorato su richiesta e venduto solo a scatole complete / Manufactured upon request and only full boxes sold / Seulement à la demande et vendus par boîte complete / Nur auf Anfrage und nur volle Karton

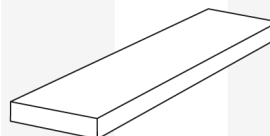

33x60x4 (13"x24") Scalino incollato - 9 mm - Rettificato

◆ Lappato

ISL3	ONICE HONEY	129,40	PZ	4	0,79	21,70	19,01	533,80	24
ISL1	ONICE MULTICOLOR	129,40							
ISL2	ONICE PEARL	129,40							

Lavorato su richiesta e venduto solo a scatole complete / Manufactured upon request and only full boxes sold / Seulement à la demande et vendus par boîte complete / Nur auf Anfrage und nur volle Karton

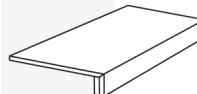

33x33x4 (13"x13") Scalino angolare incollato - 9 mm - Rettificato

◆ Lappato

ISB3	ONICE HONEY	158,00	PZ	4	0,44	14,48	13,07	447,40	30
ISB1	ONICE MULTICOLOR	158,00							
ISB2	ONICE PEARL	158,00							

Lavorato su richiesta e venduto solo a scatole complete / Manufactured upon request and only full boxes sold / Seulement à la demande et vendus par boîte complete / Nur auf Anfrage und nur volle Karton



ONICE

Size	Code	Colour	Euro	U.M.	Pcs / Box	Mq / Box	Kg / Box	Mq / Pallet	Kg / Pallet	Box / Pallet
------	------	--------	------	------	--------------	-------------	-------------	----------------	----------------	-----------------

ONICE

EFFETTO MARMO - MARBLE EFFECT - EFFET MARBRE - MARMOR EFFEKT

4,6x120 (1.80"x48") Battiscopa - 9 mm - Rettificato

◆ Lappato

					Mt				
ISR3	ONICE HONEY	34,20	PZ	6	7,20	7,80	345,60	387,40	48
ISR1	ONICE MULTICOLOR	34,20					Venduti solo a scatole complete / Only full boxes sold / Vendus par boîte complete / Nur volle Karton		
ISR2	ONICE PEARL	34,20							



7,2x60 (2.80"x24") Battiscopa - 9 mm - Rettificato

◆ Lappato

					Mt				
R3IS	ONICE HONEY	16,30	PZ	10	6,00	10,48	480,00	851,40	80
R1IS	ONICE MULTICOLOR	16,30					Venduti solo a scatole complete / Only full boxes sold / Vendus par boîte complete / Nur volle Karton		
R2IS	ONICE PEARL	16,30							



ONICE

Size	Code	Colour	Euro	U.M.	Pcs / Box	Mq / Box	Kg / Box	Mq / Pallet	Kg / Pallet	Box / Pallet
------	------	--------	------	------	-----------	----------	----------	-------------	-------------	--------------

PERCORSI EXTRA

EFFETTO PIETRA - STONE EFFECT - EFFET PIERRE - STEIN EFFEKT

60x60 (24"x24") - 9 mm - Rettificato

▲ Structured R11

J601	PERCORSI EXTRA PIETRA DI BARGE	64,40	MQ	3	1,08	21,00	43,20	853,00	40
J602	PERCORSI EXTRA PIETRA DI COMBE	64,40							
J603	PERCORSI EXTRA PIETRA DI FAEDIS	66,70							
J604	PERCORSI EXTRA PIETRA DI VALS	66,70							

30x60 (12"x24") - 9 mm - Rettificato

▲ Structured R11

J61L	PERCORSI EXTRA PIETRA DI BARGE	53,50	MQ	7	1,26	25,00	50,40	1.016,00	40
J62K	PERCORSI EXTRA PIETRA DI COMBE	53,50							
J63K	PERCORSI EXTRA PIETRA DI FAEDIS	55,70							
J64K	PERCORSI EXTRA PIETRA DI VALS	55,70							

120x240 (48"x96") (119,5x239)* - 20 mm - Rettificato

▲ Structured R11

L16J	PERCORSI EXTRA PIETRA DI VALS	194,10	MQ	1	2,86	134,20	25,70	1.302,80	9
------	-------------------------------	--------	----	---	------	--------	-------	----------	---

Addebito pallet (prezzo netto) / Extra pallet (net price) / Palette supplémentaire (prix net) / Aufpreispalette (Nettopreis) - € 140

120x120 (48"x48") - 20 mm - Rettificato

▲ Structured R11

J61Y	PERCORSI EXTRA PIETRA DI BARGE	140,30	MQ	1	1,43	67,10	28,56	1.377,00	20
S62Y	PERCORSI EXTRA PIETRA DI VALS	144,80							

60x120 (24"x48") - 20 mm - Rettificato

▲ Structured R11

J691	PERCORSI EXTRA PIETRA DI BARGE	120,80	MQ	1	0,72	33,75	25,20	1.202,25	35
J694	PERCORSI EXTRA PIETRA DI VALS	124,40							

Size	Code	Colour	Euro	U.M.	Pcs / Box	Mq / Box	Kg / Box	Mq / Pallet	Kg / Pallet	Box / Pallet
------	------	--------	------	------	-----------	----------	----------	-------------	-------------	--------------

PERCORSI EXTRA

EFFETTO PIETRA - STONE EFFECT - EFFET PIERRE - STEIN EFFEKT

45x90 (18"x36") - 20 mm - Rettificato

▲ Structured R11

j6W1	PERCORSI EXTRA PIETRA DI BARGE	100,80	MQ	2	0,81	37,40	21,87	1.027,80	27
j6W2	PERCORSI EXTRA PIETRA DI COMBE	100,80							
j6W3	PERCORSI EXTRA PIETRA DI FAEDIS	104,40							
j6W4	PERCORSI EXTRA PIETRA DI VALS	104,40							

60x60 (24"x24") - 20 mm - Rettificato

▲ Structured R11

J6w1	PERCORSI EXTRA PIETRA DI BARGE	97,00	MQ	2	0,72	30,70	21,60	934,00	30
J6w2	PERCORSI EXTRA PIETRA DI COMBE	97,00							
J6w3	PERCORSI EXTRA PIETRA DI FAEDIS	100,30							
J6w4	PERCORSI EXTRA PIETRA DI VALS	100,30							
ZAw3	PERCORSI EXTRA SIGHT ANTHR.	99,70							

PERCORSI EXTRA

30x60 (12"x24") Mosaico multispessore - 9 mm - Rettificato

▲ Structured R11

J6m1	PERCORSI EXTRA PIETRA DI BARGE	80,50	PZ	4	0,72	18,00	17,28	445,00	24
J6m2	PERCORSI EXTRA PIETRA DI COMBE	80,50							
J6m3	PERCORSI EXTRA PIETRA DI FAEDIS	80,50							
J6m4	PERCORSI EXTRA PIETRA DI VALS	80,50							

Venduti solo a scatole complete / Only full boxes sold /
Vendus par boite complete / Nur volle Karton

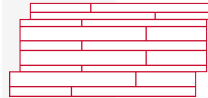

Da posare senza stuccatura / To be installed without grouting / A poser sans mastic / Ohne Ausfugung zu verlegen

104x57 Coda di pavone - 9 mm - Rettificato

▲ Structured R11

J6C1	PERCORSI EXTRA PIETRA DI BARGE	62,80	PZ	3	1,08	16,90	16,20	266,50	15
J6C2	PERCORSI EXTRA PIETRA DI COMBE	62,80							
J6C3	PERCORSI EXTRA PIETRA DI FAEDIS	62,80							
J6C4	PERCORSI EXTRA PIETRA DI VALS	62,80							

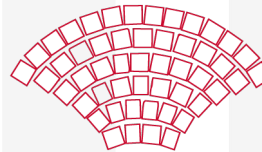

Venduti solo a scatole complete / Only full boxes sold /
Vendus par boite complete / Nur volle Karton

Size	Code	Colour	Euro	U.M.	Pcs / Box	Mq / Box	Kg / Box	Mq / Pallet	Kg / Pallet	Box / Pallet
------	------	--------	------	------	-----------	----------	----------	-------------	-------------	--------------

PERCORSI EXTRA

EFFETTO PIETRA - STONE EFFECT - EFFET PIERRE - STEIN EFFEKT

31x31 (12"x12") Mosaico burattato - 9 mm - Rettificato

▲ Structured R11

J6M1	PERCORSI EXTRA PIETRA DI BARGE	17,20	PZ	6	0,57	11,20	34,20	685,00	60
J6M2	PERCORSI EXTRA PIETRA DI COMBE	17,20							
J6M3	PERCORSI EXTRA PIETRA DI FAEDIS	17,20							
J6M4	PERCORSI EXTRA PIETRA DI VALS	17,20							

Venduti solo a scatole complete / Only full boxes sold /
Vendus par boîte complete / Nur volle Karton

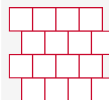

33x60x4 (13"x24") Scalino incollato - 9 mm - Rettificato

▲ Structured R11

J6S1	PERCORSI EXTRA PIETRA DI BARGE	113,20	PZ	4	0,79	21,70	19,01	533,80	24
J6S2	PERCORSI EXTRA PIETRA DI COMBE	113,20							
J6S3	PERCORSI EXTRA PIETRA DI FAEDIS	113,20							
J6S4	PERCORSI EXTRA PIETRA DI VALS	113,20							

Lavorato su richiesta e venduto solo a scatole complete / Manufactured upon request
and only full boxes sold / Seulement à la demande et vendus par boîte complete / Nur
auf Anfrage und nur volle Karton

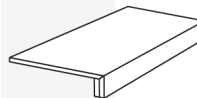

33x33x4 (13"x13") Scalino angolare incollato - 9 mm - Rettificato

▲ Structured R11

J6A1	PERCORSI EXTRA PIETRA DI BARGE	138,30	PZ	4	0,44	14,48	13,07	447,40	30
J6A2	PERCORSI EXTRA PIETRA DI COMBE	138,30							
J6A3	PERCORSI EXTRA PIETRA DI FAEDIS	138,30							
J6A4	PERCORSI EXTRA PIETRA DI VALS	138,30							

Lavorato su richiesta e venduto solo a scatole complete / Manufactured upon request
and only full boxes sold / Seulement à la demande et vendus par boîte complete / Nur
auf Anfrage und nur volle Karton



15x30x4 Terminale L incollato - 9 mm - Rettificato

▲ Structured R11

J6E1	PERCORSI EXTRA PIETRA DI BARGE	34,00	PZ	10	0,45	14,90	14,40	489,80	32
J6E2	PERCORSI EXTRA PIETRA DI COMBE	34,00							
J6E3	PERCORSI EXTRA PIETRA DI FAEDIS	34,00							
J6E4	PERCORSI EXTRA PIETRA DI VALS	34,00							

Lavorato su richiesta e venduto solo a scatole complete / Manufactured upon request
and only full boxes sold / Seulement à la demande et vendus par boîte complete / Nur
auf Anfrage und nur volle Karton

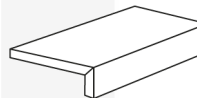

16,5x30x3,8 Terminale L monolitico - 10 mm - Rettificato

▲ Structured R11

j6l1	PERCORSI EXTRA PIETRA DI BARGE	18,80	PZ	10	0,00		16,34	442,00	33
j6l2	PERCORSI EXTRA PIETRA DI COMBE	18,80							
j6l3	PERCORSI EXTRA PIETRA DI FAEDIS	18,80							
j6l4	PERCORSI EXTRA PIETRA DI VALS	18,80							

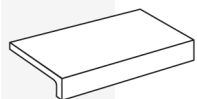

PERCORSI EXTRA

Size	Code	Colour	Euro	U.M.	Pcs / Box	Mq / Box	Kg / Box	Mq / Pallet	Kg / Pallet	Box / Pallet
------	------	--------	------	------	--------------	-------------	-------------	----------------	----------------	-----------------

PERCORSI EXTRA

EFFETTO PIETRA - STONE EFFECT - EFFET PIERRE - STEIN EFFEKT

7,2x60 (2.80"x24") Battiscopa - 9 mm - Rettificato

▲ Structured R11				Mt						
J6r1	PERCORSI EXTRA PIETRA DI BARGE	11,70	PZ	10	6,00	10,48	480,00	851,40	80	
J6Y2	PERCORSI EXTRA PIETRA DI COMBE	11,70		Venduti solo a scatole complete / Only full boxes sold / Vendus par boîte complete / Nur volle Karton						
J6Y3	PERCORSI EXTRA PIETRA DI FAEDIS	11,70								
J6Y4	PERCORSI EXTRA PIETRA DI VALS	11,70								

PERCORSI EXTRA

Size	Code	Colour	Euro	U.M.	Pcs / Box	Mq / Box	Kg / Box	Mq / Pallet	Kg / Pallet	Box / Pallet
------	------	--------	------	------	--------------	-------------	-------------	----------------	----------------	-----------------

PERCORSI FRAME

EFFETTO PIETRA - STONE EFFECT - EFFET PIERRE - STEIN EFFEKT

60x120 (24"x48") - 9 mm - Rettificato

□ Spazzolato R10

GJ2D	PERCORSI FRAME GNEISS GREY	83,00	MQ	2	1,44	31,93	50,40	1.138,00	35
GJ3D	PERCORSI FRAME IMPERIALE WALNUT	86,10							
GJ1D	PERCORSI FRAME PLIMA SILVER	83,00							
GJ5D	PERCORSI FRAME TRAVERTINO BEIGE	86,10							

60x60 (24"x24") - 9 mm - Rettificato

□ Spazzolato R10

GJ2H	PERCORSI FRAME GNEISS GREY	61,90	MQ	3	1,08	21,00	43,20	853,00	40
GJ3H	PERCORSI FRAME IMPERIALE WALNUT	64,30							
GJ1H	PERCORSI FRAME PLIMA SILVER	61,90							
GJ5H	PERCORSI FRAME TRAVERTINO BEIGE	64,30							

▲ Structured R11

H4GJ	PERCORSI FRAME GNEISS GREY	61,90							
H3GJ	PERCORSI FRAME IMPERIALE WALNUT	64,30							
H1GJ	PERCORSI FRAME PLIMA SILVER	61,90							
H5GJ	PERCORSI FRAME TRAVERTINO BEIGE	64,30							

30x60 (12"x24") - 9 mm - Rettificato

□ Spazzolato R10

GJ2I	PERCORSI FRAME GNEISS GREY	52,50	MQ	7	1,26	25,00	50,40	1.016,00	40
GJ3I	PERCORSI FRAME IMPERIALE WALNUT	54,10							
GJ1I	PERCORSI FRAME PLIMA SILVER	52,50							
GJ5I	PERCORSI FRAME TRAVERTINO BEIGE	54,10							

▲ Structured R11

I2GJ	PERCORSI FRAME GNEISS GREY	52,50							
I3GJ	PERCORSI FRAME IMPERIALE WALNUT	54,10							
I1GJ	PERCORSI FRAME PLIMA SILVER	52,50							
5IGJ	PERCORSI FRAME TRAVERTINO BEIGE	54,10							

PERCORSI FRAME

Size	Code	Colour	Euro	U.M.	Pcs / Box	Mq / Box	Kg / Box	Mq / Pallet	Kg / Pallet	Box / Pallet
------	------	--------	------	------	-----------	----------	----------	-------------	-------------	--------------

PERCORSI FRAME

EFFETTO PIETRA - STONE EFFECT - EFFET PIERRE - STEIN EFFEKT

60x120 (24"x48") - 20 mm - Rettificato

▲ Structured R11

GJW2	PERCORSI FRAME GNEISS GREY	118,00	MQ	1	0,72	33,75	25,20	1.202,25	35
GJW3	PERCORSI FRAME IMPERIALE WALNUT	122,70							
GJW1	PERCORSI FRAME PLIMA SILVER	118,00							
GJW5	PERCORSI FRAME TRAVERTINO BEIGE	122,70							



60x60 (24"x24") - 20 mm - Rettificato

▲ Structured R11

GJ2W	PERCORSI FRAME GNEISS GREY	96,80	MQ	2	0,72	30,70	21,60	934,00	30
GJ3W	PERCORSI FRAME IMPERIALE WALNUT	100,60							
GJ1W	PERCORSI FRAME PLIMA SILVER	96,80							
GJ5W	PERCORSI FRAME TRAVERTINO BEIGE	100,60							



104x57 Coda di pavone - 9 mm - Rettificato

▲ Structured R11

GJC2	PERCORSI FRAME GNEISS GREY	62,80	PZ	3	1,08	16,90	16,20	266,50	15
GJC3	PERCORSI FRAME IMPERIALE WALNUT	62,80							
GJC1	PERCORSI FRAME PLIMA SILVER	62,80							
GJC5	PERCORSI FRAME TRAVERTINO BEIGE	62,80							

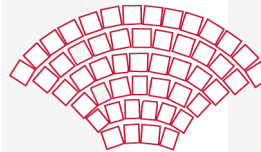

Venduti solo a scatole complete / Only full boxes sold /
Vendus par boite complete / Nur volle Karton

31x31 (12"x12") Mosaico burattato - 9 mm - Rettificato

▲ Structured R11

GJM2	PERCORSI FRAME GNEISS GREY	17,20	PZ	6	0,57	11,20	34,20	685,00	60
GJM3	PERCORSI FRAME IMPERIALE WALNUT	17,20							
GJM1	PERCORSI FRAME PLIMA SILVER	17,20							
GJM5	PERCORSI FRAME TRAVERTINO BEIGE	17,20							

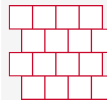

Venduti solo a scatole complete / Only full boxes sold /
Vendus par boite complete / Nur volle Karton

15x30x4 Terminale L monolitico - 8,5 mm - Non rettificato

▲ Structured R11

GJT2	PERCORSI FRAME GNEISS GREY	19,70	PZ	8	0,36	9,00	17,28	445,00	48
GJT3	PERCORSI FRAME IMPERIALE WALNUT	19,70							
GJT1	PERCORSI FRAME PLIMA SILVER	19,70							
GJT5	PERCORSI FRAME TRAVERTINO BEIGE	19,70							

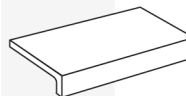

Size	Code	Colour	Euro	U.M.	Pcs / Box	Mq / Box	Kg / Box	Mq / Pallet	Kg / Pallet	Box / Pallet
------	------	--------	------	------	-----------	----------	----------	-------------	-------------	--------------

PERCORSI FRAME

EFFETTO PIETRA - STONE EFFECT - EFFET PIERRE - STEIN EFFEKT

33x120x4 (13"x48") Scalino incollato - 9 mm - Rettificato

□ Spazzolato R10

GJ2Q	PERCORSI FRAME GNEISS GREY	235,10	PZ	2	0,79	18,40	19,01	454,60	24
GJ3Q	PERCORSI FRAME IMPERIALE WALNUT	235,10							
GJ1Q	PERCORSI FRAME PLIMA SILVER	235,10							
GJ5Q	PERCORSI FRAME TRAVERTINO BEIGE	235,10							

Lavorato su richiesta e venduto solo a scatole complete / Manufactured upon request and only full boxes sold / Seulement à la demande et vendus par boîte complete / Nur auf Anfrage und nur volle Karton

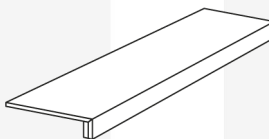

33x120x4 (13"x48") Scalino angolare incollato - 9 mm - Rettificato

□ Spazzolato R10

GJ2X	P. FRAME GREY ANG. DX	258,50	PZ	1	0,40	9,00	9,50	238,60	24
GJ2Y	P. FRAME GREY ANG. SX	258,50							
GJ1X	P. FRAME PLIMA SILVER ANG. DX	258,50							
GJ1Y	P. FRAME PLIMA SILVER ANG. SX	258,50							
GJ5X	P. FRAME TRAVERTINO BEIGE ANG. DX	258,50							
GJ5Y	P. FRAME TRAVERTINO BEIGE ANG. SX	258,50							
GJ3X	P. FRAME WALNUT ANG. DX	258,50							
GJ3Y	P. FRAME WALNUT ANG. SX	258,50							

Lavorato su richiesta e venduto solo a scatole complete / Manufactured upon request and only full boxes sold / Seulement à la demande et vendus par boîte complete / Nur auf Anfrage und nur volle Karton

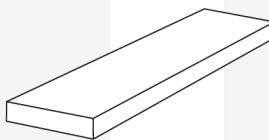

33x60x4 (13"x24") Scalino incollato - 9 mm - Rettificato

▲ Structured R11

S2GJ	PERCORSI FRAME GNEISS GREY	113,20	PZ	4	0,79	21,70	19,01	533,80	24
S3GJ	PERCORSI FRAME IMPERIALE WALNUT	113,20							
S1GJ	PERCORSI FRAME PLIMA SILVER	113,20							
S5GJ	PERCORSI FRAME TRAVERTINO BEIGE	113,20							

Lavorato su richiesta e venduto solo a scatole complete / Manufactured upon request and only full boxes sold / Seulement à la demande et vendus par boîte complete / Nur auf Anfrage und nur volle Karton

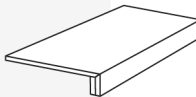

33x33x4 (13"x13") Scalino angolare incollato - 9 mm - Rettificato

▲ Structured R11

V2GJ	PERCORSI FRAME GNEISS GREY	138,30	PZ	4	0,44	14,48	13,07	447,40	30
V3GJ	PERCORSI FRAME IMPERIALE WALNUT	138,30							
V1GJ	PERCORSI FRAME PLIMA SILVER	138,30							
V5GJ	PERCORSI FRAME TRAVERTINO BEIGE	138,30							

Lavorato su richiesta e venduto solo a scatole complete / Manufactured upon request and only full boxes sold / Seulement à la demande et vendus par boîte complete / Nur auf Anfrage und nur volle Karton



Size	Code	Colour	Euro	U.M.	Pcs / Box	Mq / Box	Kg / Box	Mq / Pallet	Kg / Pallet	Box / Pallet
------	------	--------	------	------	-----------	----------	----------	-------------	-------------	--------------

PERCORSI FRAME

EFFETTO PIETRA - STONE EFFECT - EFFET PIERRE - STEIN EFFEKT

15x30x4 Terminale L incollato - 9 mm - Rettificato

▲ Structured R11

E2GJ	PERCORSI FRAME GNEISS GREY	34,00	PZ	10	0,45	14,90	14,40	489,80	32
E3GJ	PERCORSI FRAME IMPERIALE WALNUT	34,00							
E1GJ	PERCORSI FRAME PLIMA SILVER	34,00							
E5GJ	PERCORSI FRAME TRAVERTINO BEIGE	34,00							

Lavorato su richiesta e venduto solo a scatole complete / Manufactured upon request and only full boxes sold / Seulement à la demande et vendus par boîte complete / Nur auf Anfrage und nur volle Karton

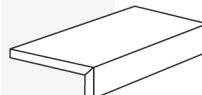

7,2x60 (2.80"x24") Battiscopa - 9 mm - Rettificato

□ Spazzolato R10

				Mt						
GJ2R	PERCORSI FRAME GNEISS GREY	11,70	PZ	10	6,00	10,48	480,00	851,40	80	
GJ3R	PERCORSI FRAME IMPERIALE WALNUT	11,70								
GJ1R	PERCORSI FRAME PLIMA SILVER	11,70								
GJ5R	PERCORSI FRAME TRAVERTINO BEIGE	11,70								

Venduti solo a scatole complete / Only full boxes sold / Vendus par boîte complete / Nur volle Karton



PERCORSI FRAME

Size	Code	Colour	Euro	U.M.	Pcs / Box	Mq / Box	Kg / Box	Mq / Pallet	Kg / Pallet	Box / Pallet
------	------	--------	------	------	-----------	----------	----------	-------------	-------------	--------------

PERCORSI SMART

EFFETTO PIETRA - STONE EFFECT - EFFET PIERRE - STEIN EFFEKT

22,5x45,3 (9"x18") - 8,5 mm - Non rettificato

■ Structured R10

1YS6	PERCORSI SMART PIETRA DI BAGNOLO	41,60	MQ	13	1,32	22,80	52,65	912,00	40
2YS6	PERCORSI SMART PIETRA DI BRESSA	43,40							

60x60 (24"x24") - 9 mm - Rettificato

● Natural R9

s601	PERCORSI SMART PIETRA DI BAGNOLO	62,20	MQ	3	1,08	21,00	43,20	853,00	40
s604	PERCORSI SMART PIETRA DI LAVIS	65,20							

▲ Structured R11

S601	PERCORSI SMART PIETRA DI BAGNOLO	60,80							
S602	PERCORSI SMART PIETRA DI BRESSA	63,80							
S604	PERCORSI SMART PIETRA DI LAVIS	63,80							

30x60 (12"x24") - 9 mm - Rettificato

● Natural R9

S61D	PERCORSI SMART PIETRA DI BAGNOLO	51,90	MQ	7	1,26	25,00	50,40	1.016,00	40
S63D	PERCORSI SMART PIETRA DI LAVIS	54,50							

▲ Structured R11

S61K	PERCORSI SMART PIETRA DI BAGNOLO	50,70							
S62K	PERCORSI SMART PIETRA DI BRESSA	53,10							
S63K	PERCORSI SMART PIETRA DI LAVIS	53,10							

120x240 (48"x96") (119,5x239)* - 20 mm - Rettificato

▲ Structured R11

S671	PERCORSI SMART PIETRA DI BAGNOLO	188,20	MQ	1	2,86	134,20	25,70	1.302,80	9
S672	PERCORSI SMART PIETRA DI BRESSA	190,90							
S674	PERCORSI SMART PIETRA DI LAVIS	190,90							

Addebito pallet (prezzo netto) / Extra pallet (net price) / Palette supplémentaire (prix net) / Aufpreispalette (Nettopreis) - € 140

PERCORSI SMART

Size	Code	Colour	Euro	U.M.	Pcs / Box	Mq / Box	Kg / Box	Mq / Pallet	Kg / Pallet	Box / Pallet
------	------	--------	------	------	-----------	----------	----------	-------------	-------------	--------------

PERCORSI SMART

EFFETTO PIETRA - STONE EFFECT - EFFET PIERRE - STEIN EFFEKT

30x240 (12"x96") (30x239)* - 20 mm - Rettificato

▲ Structured R11

S6a1	PERCORSI SMART PIETRA DI BAGNOLO	223,70	MQ	1	0,72	31,00	25,81	1.211,00	36
S6a2	PERCORSI SMART PIETRA DI BRESSA	226,90							
S6a4	PERCORSI SMART PIETRA DI LAVIS	226,90							

Ordine minimo 25,81 mq / Minimum order quantity 25,81 sqm / Commande minimum 25,81 Mq / Mindestbestellmenge 25,81 Mq

Addebito pallet (prezzo netto) / Extra pallet (net price) / Palette supplémentaire (prix net) / Aufpreispalette (Nettopreis) - € 140

45x90 (18"x36") - 20 mm - Rettificato

▲ Structured R11

s6W1	PERCORSI SMART PIETRA DI BAGNOLO	100,20	MQ	2	0,81	37,40	21,87	1.027,80	27
S62S	PERCORSI SMART PIETRA DI BRESSA	103,70							
s6W4	PERCORSI SMART PIETRA DI LAVIS	103,70							

60x60 (24"x24") - 20 mm - Rettificato

▲ Structured R11

S6w1	PERCORSI SMART PIETRA DI BAGNOLO	96,10	MQ	2	0,72	30,70	21,60	934,00	30
S6w2	PERCORSI SMART PIETRA DI BRESSA	99,50							
S6w4	PERCORSI SMART PIETRA DI LAVIS	99,50							

104x57 Coda di pavone - 9 mm - Rettificato

▲ Structured R11

S6c1	PERCORSI SMART PIETRA DI BAGNOLO	62,80	PZ	3	1,08	16,90	16,20	266,50	15
S6c2	PERCORSI SMART PIETRA DI BRESSA	62,80							
S6c4	PERCORSI SMART PIETRA DI LAVIS	62,80							

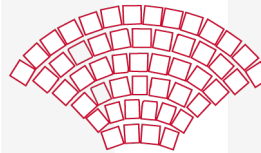

15x30x4 Terminale L monolitico - 8,5 mm - Non rettificato

■ Structured R10

T1S6	PERCORSI SMART PIETRA DI BAGNOLO	19,70	PZ	8	0,36	9,00	17,28	445,00	48
T2S6	PERCORSI SMART PIETRA DI BRESSA	19,70							

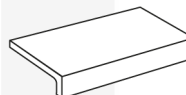

PERCORSI SMART

Size	Code	Colour	Euro	U.M.	Pcs / Box	Mq / Box	Kg / Box	Mq / Pallet	Kg / Pallet	Box / Pallet
------	------	--------	------	------	-----------	----------	----------	-------------	-------------	--------------

PERCORSI SMART

EFFETTO PIETRA - STONE EFFECT - EFFET PIERRE - STEIN EFFEKT

33x60x4 (13"x24") Scalino incollato - 9 mm - Rettificato

● Natural R9

s6S1	PERCORSI SMART PIETRA DI BAGNOLO	113,20	PZ	4	0,79	21,70	19,01	533,80	24
s6S4	PERCORSI SMART PIETRA DI LAVIS	113,20							

Lavorato su richiesta e venduto solo a scatole complete / Manufactured upon request and only full boxes sold / Seulement à la demande et vendus par boîte complete / Nur auf Anfrage und nur volle Karton

▲ Structured R11

S6S1	PERCORSI SMART PIETRA DI BAGNOLO	113,20							
S6S2	PERCORSI SMART PIETRA DI BRESSA	113,20							
S6S4	PERCORSI SMART PIETRA DI LAVIS	113,20							

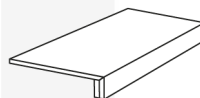

33x33x4 (13"x13") Scalino angolare incollato - 9 mm - Rettificato

● Natural R9

s6A1	PERCORSI SMART PIETRA DI BAGNOLO	138,30	PZ	4	0,44	14,48	13,07	447,40	30
s6A4	PERCORSI SMART PIETRA DI LAVIS	138,30							

Lavorato su richiesta e venduto solo a scatole complete / Manufactured upon request and only full boxes sold / Seulement à la demande et vendus par boîte complete / Nur auf Anfrage und nur volle Karton

▲ Structured R11

S6A1	PERCORSI SMART PIETRA DI BAGNOLO	138,30							
S6A2	PERCORSI SMART PIETRA DI BRESSA	138,30							
S6A4	PERCORSI SMART PIETRA DI LAVIS	138,30							



15x30x4 Terminale L incollato - 9 mm - Rettificato

● Natural R9

s6E1	PERCORSI SMART PIETRA DI BAGNOLO	34,00	PZ	10	0,45	14,90	14,40	489,80	32
s6E4	PERCORSI SMART PIETRA DI LAVIS	34,00							

Lavorato su richiesta e venduto solo a scatole complete / Manufactured upon request and only full boxes sold / Seulement à la demande et vendus par boîte complete / Nur auf Anfrage und nur volle Karton

▲ Structured R11

S6E1	PERCORSI SMART PIETRA DI BAGNOLO	34,00							
S6E2	PERCORSI SMART PIETRA DI BRESSA	34,00							
S6E4	PERCORSI SMART PIETRA DI LAVIS	34,00							

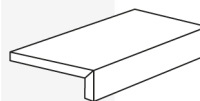

16,5x30x3,8 Terminale L monolitico - 10 mm - Non rettificato

▲ Structured R11

s6e1	PERCORSI SMART PIETRA DI BAGNOLO	18,80	PZ	10	0,495		16,34	442,00	33
s6e2	PERCORSI SMART PIETRA DI BRESSA	18,80							
s6e4	PERCORSI SMART PIETRA DI LAVIS	18,80							

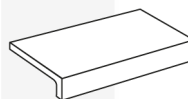

Size	Code	Colour	Euro	U.M.	Pcs / Box	Mq / Box	Kg / Box	Mq / Pallet	Kg / Pallet	Box / Pallet
------	------	--------	------	------	-----------	----------	----------	-------------	-------------	--------------

PERCORSI SMART

EFFETTO PIETRA - STONE EFFECT - EFFET PIERRE - STEIN EFFEKT

7,2x60 (2.80"x24") Battiscopa - 9 mm - Rettificato

● Natural R9

				Mt						
s6Y1	PERCORSI SMART PIETRA DI BAGNOLO	11,70	PZ	10	6,00	10,48	480,00	851,40	80	
s6Y4	PERCORSI SMART PIETRA DI LAVIS	11,70		Venduti solo a scatole complete / Only full boxes sold / Vendus par boîte complete / Nur volle Karton						

▲ Structured R11

S6R1	PERCORSI SMART PIETRA DI BAGNOLO	11,70	
S6R2	PERCORSI SMART PIETRA DI BRESSA	11,70	
S6R4	PERCORSI SMART PIETRA DI LAVIS	11,70	



7,2x45,3 (2.80"x18") Battiscopa - 9 mm - Non rettificato

■ Structured R10

				Mt						
1RS6	PERCORSI SMART PIETRA DI BAGNOLO	7,20	PZ	12	5,44	7,90	456,62	676,60	84	
2RS6	PERCORSI SMART PIETRA DI BRESSA	7,20		Venduti solo a scatole complete / Only full boxes sold / Vendus par boîte complete / Nur volle Karton						

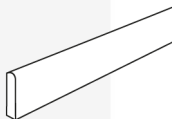

PERCORSI SMART

Size	Code	Colour	Euro	U.M.	Pcs / Box	Mq / Box	Kg / Box	Mq / Pallet	Kg / Pallet	Box / Pallet
------	------	--------	------	------	--------------	-------------	-------------	----------------	----------------	-----------------

PLATE

METALLI - METALLI - METALLI - METALLI

120x278 (48"x110") (119,5x278)* - 6 mm - Rettificato

● Natural R9

IEA6	PLATE ANTHRACITE	128,80	MQ	1	3,32	49,56	59,80	990,08	18
IEA3	PLATE OXYDE	133,90							
IEA7	PLATE TIN	125,70							
IEA1	PLATE ZINC	125,70							

Addebito cassa leggera (max7pz) (prezzo netto) / Light crate charge (max7pz) (net price) / Débit de caisse (max7pz) (prix net) / Kasse belasten (max7pz) (Nettopreis) - € 100
 Addebito cassa (prezzo netto) / Crate charge (net price) / Palette supplémentaire (prix net) / Aufpreispalette (Nettopreis) - € 160
 Addebito cavalletto 18pz (prezzo netto) / Extra rack 18pcs (net price) / Chevalet supplémentaire 18pcs (prix net) / Aufpreisgestell 18St (Nettopreis) - € 270
 Addebito cavalletto 42pz (prezzo netto) / Extra rack 42pcs (net price) / Chevalet supplémentaire 42pcs (prix net) / Aufpreisgestell 42St (Nettopreis) - € 270

120x120 (48"x48") (119,5x119,5)* - 9 mm - Rettificato

● Natural R9

IEC6	PLATE ANTHRACITE	102,50	MQ	2	2,86	60,80	57,12	1.251,00	20
IEC4	PLATE BRASS	102,50							
IEC5	PLATE COPPER	106,60							
IEC7	PLATE OXYDE	106,60							
IEC2	PLATE SILVER	99,90							
IE7C	PLATE TIN	99,90							
IEC8	PLATE TITANIUM	102,50							
IEC1	PLATE ZINC	102,50							

60x120 (24"x48") - 9 mm - Rettificato

● Natural R9

IED6	PLATE ANTHRACITE	84,50	MQ	2	1,44	31,93	50,40	1.138,00	35
IED4	PLATE BRASS	84,50							
IED5	PLATE COPPER	88,10							
IED3	PLATE OXYDE	88,10							
IED2	PLATE SILVER	81,40							
IED7	PLATE TIN	81,40							
IED8	PLATE TITANIUM	84,50							
IED1	PLATE ZINC	84,50							

PLATE

Size	Code	Colour	Euro	U.M.	Pcs / Box	Mq / Box	Kg / Box	Mq / Pallet	Kg / Pallet	Box / Pallet
------	------	--------	------	------	-----------	----------	----------	-------------	-------------	--------------

PLATE

METALLI - METALLI - METALLI - METALLI

80x80 (32"x32") - 9 mm - Rettificato

● Natural R9

IEG6	PLATE ANTHRACITE	78,30	MQ	2	1,28	25,60	61,44	1.253,80	42
IEG2	PLATE SILVER	75,70							
IEG7	PLATE TIN	75,70							
IEG1	PLATE ZINC	78,30							

120x278 (48"x110") (119,5x278)* Decoro - 6 mm - Rettificato

● Natural R9

IEK2	PLATE LUXURY GOLD	587,10	MQ	1	3,32		59,80	990,08	18
IEK3	PLATE LUXURY PLATINUM	587,10							
IEK1	PLATE PRECIOUS DARK	587,10							

60x120 (24"x48") Decoro - 9 mm - Rettificato

● Natural R9

IEJ2	PLATE LUXURY GOLD	587,10	MQ	2	1,44	31,93	50,40	1.138,00	35
IEJ3	PLATE LUXURY PLATINUM	587,10							
IEJ1	PLATE PRECIOUS DARK	587,10							

30x30 (12"x12") Mosaico T100 (2,8x2,8) - 9 mm - Rettificato

● Natural R9

IEM6	PLATE ANTHRACITE	27,80	PZ	6	0,54	11,20	27,00	523,00	48
IEM4	PLATE BRASS	27,80							
IEM5	PLATE COPPER	27,80							
IEM3	PLATE OXYDE	27,80							
IEM2	PLATE SILVER	27,80							
IEM7	PLATE TIN	27,80							
IEM8	PLATE TITANIUM	27,80							
IEM1	PLATE ZINC	27,80							

Venduti solo a scatole complete / Only full boxes sold /
Vendus par boite complete / Nur volle Karton

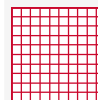

PLATE

Size	Code	Colour	Euro	U.M.	Pcs / Box	Mq / Box	Kg / Box	Mq / Pallet	Kg / Pallet	Box / Pallet
------	------	--------	------	------	-----------	----------	----------	-------------	-------------	--------------

PLATE

METALLI - METALLI - METALLI - METALLI

33x120x4 (13"x48") Scalino incollato - 9 mm - Rettificato

● Natural R9

IEQ6	PLATE ANTHRACITE	235,40	PZ	2	0,79	18,40	19,01	454,60	24
IEQ4	PLATE BRASS	235,40							
IEQ5	PLATE COPPER	235,40							
IEQ3	PLATE OXYDE	235,40							
IEQ2	PLATE SILVER	235,40							
IEQ7	PLATE TIN	235,40							
IEQ8	PLATE TITANIUM	235,40							
IEQ1	PLATE ZINC	235,40							

Lavorato su richiesta e venduto solo a scatole complete / Manufactured upon request and only full boxes sold / Seulement à la demande et vendus par boîte complete / Nur auf Anfrage und nur volle Karton

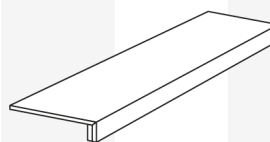

33x120x4 (13"x48") Scalino angolare incollato - 9 mm - Rettificato

● Natural R9

IEX6	PLATE ANTHRACITE ANG. DX	258,50	PZ	1	0,40	9,00	9,50	238,60	24
IEY6	PLATE ANTHRACITE ANG. SX	258,50							
IEX4	PLATE BRASS ANG. DX	258,50							
IEY4	PLATE BRASS ANG. SX	258,50							
IEX5	PLATE COPPER ANG. DX	258,50							
IEY5	PLATE COPPER ANG. SX	258,50							
IEX3	PLATE OXIDE ANG. DX	258,50							
IEY3	PLATE OXYDE ANG. SX	258,50							
IEX2	PLATE SILVER ANG. DX	258,50							
IEY2	PLATE SILVER ANG. SX	258,50							
IEX7	PLATE TIN ANG. DX	258,50							
IEY7	PLATE TIN ANG. SX	258,50							
IEX8	PLATE TITANIUM ANG. DX	258,50							
IEY8	PLATE TITANIUM ANG. SX	258,50							
IEX1	PLATE ZINC ANG. DX	258,50							
IEY1	PLATE ZING ANG. SX	258,50							

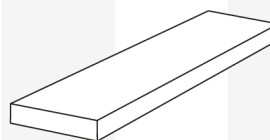

PLATE

Size	Code	Colour	Euro	U.M.	Pcs / Box	Mq / Box	Kg / Box	Mq / Pallet	Kg / Pallet	Box / Pallet
------	------	--------	------	------	-----------	----------	----------	-------------	-------------	--------------

PLATE

METALLI - METALLI - METALLI - METALLI

4,6x120 (1.80"x48") Battiscopa - 9 mm - Rettificato

● Natural R9

					Mt				
IER6	PLATE ANTHRACITE	24,70	PZ	6	7,20	7,80	345,60	387,40	48
IER4	PLATE BRASS	24,70					Venduti solo a scatole complete / Only full boxes sold / Vendus par boîte complete / Nur volle Karton		
IER5	PLATE COPPER	24,70							
IER3	PLATE OXYDE	24,70							
IER2	PLATE SILVER	24,70							
IER7	PLATE TIN	24,70							
IER8	PLATE TITANIUM	24,70							
IER1	PLATE ZINC	24,70							



7x80 (2.75"x32") Battiscopa - 9 mm - Rettificato

● Natural R9

					Mt				
IE6R	PLATE ANTHRACITE	13,40	PZ	8	6,40	9,30	460,80	682,60	72
IE2R	PLATE SILVER	13,40					Venduti solo a scatole complete / Only full boxes sold / Vendus par boîte complete / Nur volle Karton		
IE7R	PLATE TIN	13,40							
IE1R	PLATE ZINC	13,40							



PLATE

Size	Code	Colour	Euro	U.M.	Pcs / Box	Mq / Box	Kg / Box	Mq / Pallet	Kg / Pallet	Box / Pallet
------	------	--------	------	------	-----------	----------	----------	-------------	-------------	--------------

SOUL

EFFETTO LEGNO - WOOD EFFECT - EFFET BOIS - HOLZ EFFEKT

30x120 (12"x48") - 20 mm - Rettificato

▲ Structured R11

V952	SOUL GREY	139,30	MQ	2	0,72	33,05	25,92	1.203,00	36
V954	SOUL WALNUT	135,40							

SOUL

Size	Code	Colour	Euro	U.M.	Pcs / Box	Mq / Box	Kg / Box	Mq / Pallet	Kg / Pallet	Box / Pallet
------	------	--------	------	------	-----------	----------	----------	-------------	-------------	--------------

STREET

EFFETTO CEMENTO - CONCRETE EFFECT - EFFET CIMENT - ZEMENT EFFEKT

22,5x45,3 (9"x18") - 8,5 mm - Non rettificato

■ Structured R10

I4K2	STREET LONDRA BEIGE	42,20	MQ	13	1,33	22,8	52,65	912,00	40
I4K1	STREET LONDRA GREY	42,20							
I4K4	STREET MILANO IVORY	42,20							
I4K3	STREET MILANO SILVER	42,20							

15x30 Terminale L monolitico - 8,5 mm - Non rettificato

■ Structured R10

I42T	STREET LONDRA BEIGE	19,60	PZ	8	0,00	9,00	17,28	445,00	48
I4T1	STREET LONDRA GREY	19,60							
I4T4	STREET MILANO IVORY	19,60							
I4T3	STREET MILANO SILVER	19,60							

7,2x45,3 (2.80"x18") Battiscopa - 9 mm - Non rettificato

■ Structured R10

I4R2	STREET LONDRA BEIGE	7,20	PZ	12	5,44	7,90	456,62	676,60	84
I4R1	STREET LONDRA GREY	7,20							
I4R4	STREET MILANO IVORY	7,20							
I4R3	STREET MILANO SILVER	7,20							

Mt

Venduti solo a scatole complete / Only full boxes sold /
Vendus par boite complete / Nur volle Karton

STREET

Size	Code	Colour	Euro	U.M.	Pcs / Box	Mq / Box	Kg / Box	Mq / Pallet	Kg / Pallet	Box / Pallet
------	------	--------	------	------	-----------	----------	----------	-------------	-------------	--------------

TREVI

EFFETTO PIETRA - STONE EFFECT - EFFET PIERRE - STEIN EFFEKT

120x278 (48"x110") (119,5x278)* - 6 mm - Rettificato

✕ Silky

I3A1	TREVI IVORY	132,90	MQ	1	3,32	49,56	59,80	990,08	18
I3A3	TREVI PEARL	132,90							
I3A2	TREVI WALNUT	132,90							

Addebito cassa leggera (max7pz) (prezzo netto) / Light crate charge (max7pz) (net price) / Débit de caisse (max7pz) (prix net) / Kasse belasten (max7pz) (Nettopreis) - € 100
 Addebito cassa (prezzo netto) / Crate charge (net price) / Palette supplémentaire (prix net) / Aufreispalette (Nettopreis) - € 160
 Addebito cavalletto 18pz (prezzo netto) / Extra rack 18pcs (net price) / Chevalet supplémentaire 18pcs (prix net) / Aufpreisgestell 18St (Nettopreis) - € 270
 Addebito cavalletto 42pz (prezzo netto) / Extra rack 42pcs (net price) / Chevalet supplémentaire 42pcs (prix net) / Aufpreisgestell 42St (Nettopreis) - € 270

60x120 (24"x48") - 9 mm - Rettificato

✕ Silky

I3D1	TREVI IVORY	86,00	MQ	2	1,44	31,93	50,40	1.138,00	35
I3D3	TREVI PEARL	86,00							
I3D2	TREVI WALNUT	86,00							

▣ Spazzolato R10

1DI3	TREVI IVORY	83,40							
3DI3	TREVI PEARL	83,40							
2DI3	TREVI WALNUT	83,40							

60x120 (24"x48") Flute 3D - 9 mm - Rettificato

■ 3D

I3B1	TREVI IVORY FLUTE 3D	91,70	MQ	2	1,44	31,93	50,40	1.138,00	35
I3B3	TREVI PEARL FLUTE 3D	91,70							
I3B2	TREVI WALNUT FLUTE 3D	91,70							

20x120 (8"x48") Plisse - 9 mm - Rettificato

✕ Silky

I31L	TREVI IVORY	38,60	PZ	4	0,96	20,66	34,56	756,76	36
I33L	TREVI PEARL	38,60							
I32L	TREVI WALNUT	38,60							

Venduti solo a scatole complete / Only full boxes sold /
 Vendus par boite complete / Nur volle Karton

Size	Code	Colour	Euro	U.M.	Pcs / Box	Mq / Box	Kg / Box	Mq / Pallet	Kg / Pallet	Box / Pallet
------	------	--------	------	------	-----------	----------	----------	-------------	-------------	--------------

TREVI

EFFETTO PIETRA - STONE EFFECT - EFFET PIERRE - STEIN EFFEKT

18,4x120 (7"x48") Plisse 3D - 9 mm - Rettificato

✕ Silky

I3L1	TREVI IVORY	64,90	PZ	3	0,66	14,25	23,76	526,00	36
I3L3	TREVI PEARL	64,90							
I3L2	TREVI WALNUT	64,90							

Venduti solo a scatole complete / Only full boxes sold /
Vendus par boite complete / Nur volle Karton



30x60 (12"x24") Mosaico multispessore - 9 mm - Rettificato

✕ Silky

I3M1	TREVI IVORY	80,30	PZ	4	0,72	18,00	17,28	445,00	24
I3M3	TREVI PEARL	80,30							
I3M2	TREVI WALNUT	80,30							

Venduti solo a scatole complete / Only full boxes sold /
Vendus par boite complete / Nur volle Karton



Da posare senza stuccatura / To be installed without grouting / A poser sans mastic / Ohne Ausfugung zu verlegen

28,5x55,5 (11"x22") Biscuits - 9 mm - Rettificato

✕ Silky

I3P1	TREVI IVORY	38,60	PZ	6	0,95	20,40	41,80	911,00	44
I3P3	TREVI PEARL	38,60							
I3P2	TREVI WALNUT	38,60							

Venduti solo a scatole complete / Only full boxes sold /
Vendus par boite complete / Nur volle Karton

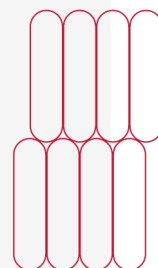

30x30 (12"x12") Mosaico listelli - 9 mm - Rettificato

✕ Silky

I31M	TREVI IVORY	20,60	PZ	11	0,99	19,25	35,64	706,00	36
I33M	TREVI PEARL	20,60							
I32M	TREVI WALNUT	20,60							

Venduti solo a scatole complete / Only full boxes sold /
Vendus par boite complete / Nur volle Karton



TREVI

Size	Code	Colour	Euro	U.M.	Pcs / Box	Mq / Box	Kg / Box	Mq / Pallet	Kg / Pallet	Box / Pallet
------	------	--------	------	------	-----------	----------	----------	-------------	-------------	--------------

TREVI

EFFETTO PIETRA - STONE EFFECT - EFFET PIERRE - STEIN EFFEKT

33x120x4 (13"x48") Scalino incollato - 9 mm - Rettificato

✕ Silky

I3Q1	TREVI IVORY	235,40	PZ	2	0,79	18,40	19,01	454,60	24
I3Q3	TREVI PEARL	235,40							
I3Q2	TREVI WALNUT	235,40							

Lavorato su richiesta e venduto solo a scatole complete / Manufactured upon request and only full boxes sold / Seulement à la demande et vendus par boîte complete / Nur auf Anfrage und nur volle Karton

□ Spazzolato R10

I31Q	TREVI IVORY	235,40							
I33Q	TREVI PEARL	235,40							
I32Q	TREVI WALNUT	235,40							

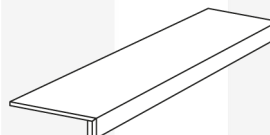

33x120x4 (13"x48") Scalino angolare incollato - 9 mm - Rettificato

✕ Silky

I3X1	TREVI IVORY ANG. DX	258,50	PZ	1	0,40	9,00	9,50	238,60	200
I3Y1	TREVI IVORY ANG. SX	258,50							
X3I3	TREVI PEARL ANG. DX	258,50							
I3Y3	TREVI PEARL ANG. SX	258,50							
I3X2	TREVI WALNUT ANG. DX	258,50							
I3Y2	TREVI WALNUT ANG. SX	258,50							

Lavorato su richiesta e venduto solo a scatole complete / Manufactured upon request and only full boxes sold / Seulement à la demande et vendus par boîte complete / Nur auf Anfrage und nur volle Karton

□ Spazzolato R10

I31X	TREVI IVORY ANG. DX	258,50							
I31Y	TREVI IVORY ANG. SX	258,50							
I33X	TREVI PEARL ANG. DX	258,50							
I33Y	TREVI PEARL ANG. SX	258,50							
I32X	TREVI WALNUT ANG. DX	258,50							
I32Y	TREVI WALNUT ANG. SX	258,50							

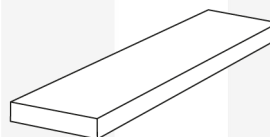

4,6x120 (1.80"x48") Battiscopa - 9 mm - Rettificato

✕ Silky

I3R1	TREVI IVORY	24,70	PZ	6	7,20	7,80	345,60	387,40	48
I3R3	TREVI PEARL	24,70							
I3R2	TREVI WALNUT	24,70							

Venduti solo a scatole complete / Only full boxes sold / Vendus par boîte complete / Nur volle Karton

□ Spazzolato R10

I31R	TREVI IVORY	24,70							
I33R	TREVI PEARL	24,70							
I32R	TREVI WALNUT	24,70							



TREVI

Size	Code	Colour	Euro	U.M.	Pcs / Box	Mq / Box	Kg / Box	Mq / Pallet	Kg / Pallet	Box / Pallet
------	------	--------	------	------	--------------	-------------	-------------	----------------	----------------	-----------------

UBIK

EFFETTO PIETRA - STONE EFFECT - EFFET PIERRE - STEIN EFFEKT

120x120 (48"x48") (119,5x119,5)* - 9 mm - Rettificato

■ Natural R10

FGC1	UBIK ANTHRACITE	102,80	MQ	2	2,86	60,80	57,12	1.251,00	20
FGC2	UBIK GREY	97,90							
FGC4	UBIK IVORY	102,80							

60x120 (24"x48") - 9 mm - Rettificato

■ Natural R10

FGD1	UBIK ANTHRACITE	86,20	MQ	2	1,44	31,93	50,40	1.138,00	35
FGD3	UBIK GREIGE	83,00							
FGD2	UBIK GREY	83,00							
FGD4	UBIK IVORY	86,20							
FGD5	UBIK WALNUT	86,20							

60x60 (24"x24") - 9 mm - Rettificato

■ Natural R10

FGH1	UBIK ANTHRACITE	63,70	MQ	3	1,08	21,00	43,20	853,00	40
FGH3	UBIK GREIGE	61,10							
FGH2	UBIK GREY	61,10							
FGH4	UBIK IVORY	63,70							
FGH5	UBIK WALNUT	63,70							

30x60 (12"x24") - 9 mm - Rettificato

■ Natural R10

FGI1	UBIK ANTHRACITE	52,80	MQ	7	1,26	25,00	50,40	1.016,00	40
FGI3	UBIK GREIGE	50,90							
FGI2	UBIK GREY	50,90							
FGI4	UBIK IVORY	52,80							
FGI5	UBIK WALNUT	52,80							

▲ Structured R11

FG1I	UBIK ANTHRACITE	52,80							
FG3I	UBIK GREIGE	50,90							
FG2I	UBIK GREY	50,90							
FG4I	UBIK IVORY	52,80							
FG5I	UBIK WALNUT	52,80							

Size	Code	Colour	Euro	U.M.	Pcs / Box	Mq / Box	Kg / Box	Mq / Pallet	Kg / Pallet	Box / Pallet
------	------	--------	------	------	-----------	----------	----------	-------------	-------------	--------------

UBIK

EFFETTO PIETRA - STONE EFFECT - EFFET PIERRE - STEIN EFFEKT

9,7x60 (3.80"x24") - 9 mm - Rettificato

■ Natural R10

FG01	UBIK ANTHRACITE	73,40	MQ	10	0,58	12,75	34,92	781,00	60
FG03	UBIK GREIGE	73,40							
FG02	UBIK GREY	73,40							
FG04	UBIK IVORY	73,40							
FG05	UBIK WALNUT	73,40							

60x120 (24"x48") - 20 mm - Rettificato

▲ Structured R11

FGW1	UBIK ANTHRACITE	122,10	MQ	1	0,72	33,75	25,20	1.202,25	35
FGW3	UBIK GREIGE	117,10							
FGW2	UBIK GREY	117,10							
FGW4	UBIK IVORY	122,10							
FGW5	UBIK WALNUT	122,10							

60x60 (24"x24") - 20 mm - Rettificato

▲ Structured R11

FG1W	UBIK ANTHRACITE	97,00	MQ	2	0,72	30,70	21,60	934,00	30
FG3W	UBIK GREIGE	94,20							
FG2W	UBIK GREY	94,20							
FG4W	UBIK IVORY	97,00							
FG5W	UBIK WALNUT	97,00							

60x120 (24"x48") Decoro Crossing 3D - 9 mm - Rettificato

■ 3D

FGC3	UBIK GREIGE	88,60	MQ	2	1,44	31,93	50,40	1.139,00	35
FG2B	UBIK GREY	88,60							
FGB4	UBIK IVORY	92,10							

UBIK

Size	Code	Colour	Euro	U.M.	Pcs / Box	Mq / Box	Kg / Box	Mq / Pallet	Kg / Pallet	Box / Pallet
------	------	--------	------	------	-----------	----------	----------	-------------	-------------	--------------

UBIK

EFFETTO PIETRA - STONE EFFECT - EFFET PIERRE - STEIN EFFEKT

9,7x60 (3.80"x24") Listello Up - 9 mm - Rettificato

● Natural R10

FGU1	UBIK ANTHRACITE	120,50	MQ	8	0,47	10,48	27,96	641,80	60
FGU3	UBIK GREIGE	116,10							
FGU2	UBIK GREY	116,10							
FGU4	UBIK IVORY	120,50							
FGU5	UBIK WALNUT	120,50							

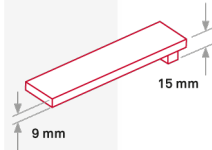

30x30 (12"x12") Mosaico T36 (4,8x4,8) - 9 mm - Rettificato

● Natural R10

FGM1	UBIK ANTHRACITE	14,00	PZ	10	0,90	17,00	27,00	523,00	30
FG3M	UBIK GREIGE	14,00							
FGM2	UBIK GREY	14,00							
FGM4	UBIK IVORY	14,00							
FGM5	UBIK WALNUT	14,00							

Venduti solo a scatole complete / Only full boxes sold /
Vendus par boîte complete / Nur volle Karton

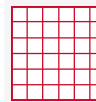

33x120x4 (13"x48") Scalino incollato - 9 mm - Rettificato

● Natural R10

FGQ1	UBIK ANTHRACITE	235,10	PZ	2	0,79	18,40	19,01	454,60	24
FGQ3	UBIK GREIGE	235,10							
FGQ2	UBIK GREY	235,10							
FGQ4	UBIK IVORY	235,10							
FGQ5	UBIK WALNUT	235,10							

Lavorato su richiesta e venduto solo a scatole complete / Manufactured upon request
and only full boxes sold / Seulement à la demande et vendus par boîte complete / Nur
auf Anfrage und nur volle Karton

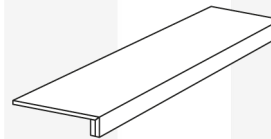

Size	Code	Colour	Euro	U.M.	Pcs / Box	Mq / Box	Kg / Box	Mq / Pallet	Kg / Pallet	Box / Pallet
------	------	--------	------	------	-----------	----------	----------	-------------	-------------	--------------

UBIK

EFFETTO PIETRA - STONE EFFECT - EFFET PIERRE - STEIN EFFEKT

33x120x4 (13"x48") Scalino angolare incollato - 9 mm - Rettificato

■ Natural R10

FGX1	UBIK ANTHRACITE ANG. DX	258,50	PZ	1	0,40	9,00	9,50	238,60	24
FGY1	UBIK ANTHRACITE ANG. SX	258,50							
FGX3	UBIK GREIGE ANG. DX	258,50							
FGY3	UBIK GREIGE ANG. SX	258,50							
FGX2	UBIK GREY ANG. DX	258,50							
FGY2	UBIK GREY ANG. SX	258,50							
FGX4	UBIK IVORY ANG. DX	258,50							
FGY4	UBIK IVORY ANG. SX	258,50							
FGX5	UBIK WALNUT ANG. DX	258,50							
FGY5	UBIK WALNUT ANG. SX	258,50							

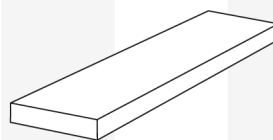

Lavorato su richiesta e venduto solo a scatole complete / Manufactured upon request and only full boxes sold / Seulement à la demande et vendus par boîte complete / Nur auf Anfrage und nur volle Karton

33x60x4 (13"x24") Scalino incollato - 9 mm - Rettificato

■ Natural R10

FGS1	UBIK ANTHRACITE	113,20	PZ	4	0,79	21,70	19,01	533,80	24
FGS3	UBIK GREIGE	113,20							
FGS2	UBIK GREY	113,20							
FGS4	UBIK IVORY	113,20							
FGS5	UBIK WALNUT	113,20							

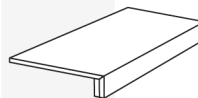

Lavorato su richiesta e venduto solo a scatole complete / Manufactured upon request and only full boxes sold / Seulement à la demande et vendus par boîte complete / Nur auf Anfrage und nur volle Karton

33x33x4 (13"x13") Scalino angolare incollato - 9 mm - Rettificato

■ Natural R10

FGV1	UBIK ANTHRACITE	138,30	PZ	4	0,44	14,48	13,07	447,40	30
FGV3	UBIK GREIGE	138,30							
FGV2	UBIK GREY	138,30							
FGV4	UBIK IVORY	138,30							
FGV5	UBIK WALNUT	138,30							



Lavorato su richiesta e venduto solo a scatole complete / Manufactured upon request and only full boxes sold / Seulement à la demande et vendus par boîte complete / Nur auf Anfrage und nur volle Karton

4,6x120 (1.80"x48") Battiscopa - 9 mm - Rettificato

■ Natural R10

R1FG	UBIK ANTHRACITE	24,70	PZ	6	7,20	7,80	345,60	387,40	48
R3FG	UBIK GREIGE	24,70							
R2FG	UBIK GREY	24,70							
R4FG	UBIK IVORY	24,70							
R5FG	UBIK WALNUT	24,70							



Venduti solo a scatole complete / Only full boxes sold / Vendus par boîte complete / Nur volle Karton

Size	Code	Colour	Euro	U.M.	Pcs / Box	Mq / Box	Kg / Box	Mq / Pallet	Kg / Pallet	Box / Pallet
------	------	--------	------	------	--------------	-------------	-------------	----------------	----------------	-----------------

UBIK

EFFETTO PIETRA - STONE EFFECT - EFFET PIERRE - STEIN EFFEKT

7,2x60 (2.80"x24") Battiscopa - 9 mm - Rettificato

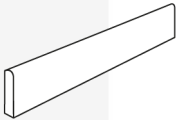
■ Natural R10				Mt						
FGR1	UBIK ANTHRACITE	11,70	PZ	10	6,00	10,48	480,00	851,40	80	
FGR3	UBIK GREIGE	11,70		Venduti solo a scatole complete / Only full boxes sold / Vendus par boîte complete / Nur volle Karton						
FGR2	UBIK GREY	11,70								
FGR4	UBIK IVORY	11,70								
FGR5	UBIK WALNUT	11,70								

UBIK

Size	Code	Colour	Euro	U.M.	Pcs / Box	Mq / Box	Kg / Box	Mq / Pallet	Kg / Pallet	Box / Pallet
------	------	--------	------	------	-----------	----------	----------	-------------	-------------	--------------

UNICA

EFFETTO LEGNO - WOOD EFFECT - EFFET BOIS - HOLZ EFFEKT

20x180 (71"x8") - 9,5 mm - Rettificato

● Natural R9

JOE3	UNICA ALMOND	90,60	MQ	5	1,80	38,00	72,00	1.533,00	40
JOE5	UNICA BEIGE	90,60							
JOE1	UNICA BROWN	92,70							
JOE6	UNICA GREY	90,60							
JOE2	UNICA HONEY	92,70							
JOE4	UNICA IVORY	90,60							

20x120 (8"x48") - 9 mm - Rettificato

● Natural R9

JOF3	UNICA ALMOND	70,60	MQ	6	1,44	29,00	60,48	1.231,00	42
JOF5	UNICA BEIGE	70,60							
JOF1	UNICA BROWN	73,10							
JOF6	UNICA GREY	70,60							
JOF2	UNICA HONEY	73,10							
JOF4	UNICA IVORY	70,60							

7,5x60 (3"x24") - 9 mm - Non rettificato

● Natural R9

JO53	UNICA ALMOND	69,50	MQ	22	0,99	19,10	59,4	1.159,00	60
JO55	UNICA BEIGE	69,50							
JO56	UNICA GREY	69,50							
JO52	UNICA HONEY	72,60							

60x120 (24"x48") Flute 3D - 9 mm - Rettificato

■ 3D

JO3B	UNICA ALMOND	91,70	MQ	2	1,44	31,93	50,40	1.138,00	36
JO5B	UNICA BEIGE	91,70							
JOB6	UNICA GREY	91,70							
JOB2	UNICA HONEY	91,70							

UNICA

Size	Code	Colour	Euro	U.M.	Pcs / Box	Mq / Box	Kg / Box	Mq / Pallet	Kg / Pallet	Box / Pallet
------	------	--------	------	------	-----------	----------	----------	-------------	-------------	--------------

UNICA

EFFETTO LEGNO - WOOD EFFECT - EFFET BOIS - HOLZ EFFEKT

20x120 (8"x48") Plisse - 9 mm - Rettificato

● Natural R9

J03L	UNICA ALMOND	38,60	PZ	4	0,96	20,66	34,56	756,76	36	
J05L	UNICA BEIGE	38,60		Venduti solo a scatole complete / Only full boxes sold / Vendus par boite complete / Nur volle Karton						
J01L	UNICA BROWN	38,60								
J06L	UNICA GREY	38,60								
J02L	UNICA HONEY	38,60								
J04L	UNICA IVORY	38,60								

18,4x120 (7"x48") Plisse 3D - 9 mm - Rettificato

● Natural R9

JOL3	UNICA ALMOND	64,90	PZ	3	0,66	14,25	23,76	526,00	36	
JOL5	UNICA BEIGE	64,90		Venduti solo a scatole complete / Only full boxes sold / Vendus par boite complete / Nur volle Karton						
JOL1	UNICA BROWN	64,90								
JOL6	UNICA GREY	64,90								
JOL2	UNICA HONEY	64,90								
JOL4	UNICA IVORY	64,90								

4,6x120 (1.80"x48") Battiscopa - 9 mm - Rettificato

● Natural R9

J03R	UNICA ALMOND	24,70	PZ	6	Mt	7,20	7,80	345,60	387,40	48
J05R	UNICA BEIGE	24,70		Venduti solo a scatole complete / Only full boxes sold / Vendus par boite complete / Nur volle Karton						
J01R	UNICA BROWN	24,70								
J06R	UNICA GREY	24,70								
J02R	UNICA HONEY	24,70								
J04R	UNICA IVORY	24,70								

UNICA

Size	Code	Colour	Euro	U.M.	Pcs / Box	Mq / Box	Kg / Box	Mq / Pallet	Kg / Pallet	Box / Pallet
------	------	--------	------	------	--------------	-------------	-------------	----------------	----------------	-----------------

VERSILIA

EFFETTO MARMO - MARBLE EFFECT - EFFET MARBRE - MARMOR EFFEKT

120x278 (48"x110") (119,5x278)* - 6 mm - Rettificato

✕ Silky

JN2A	VERSILIA BARDIGLIO SILVER	139,10	MQ	1	3,32	49,56	59,80	990,08	18
JN3A	VERSILIA FIORITO IVORY	139,10							
JN1A	VERSILIA NUVOLATO GREY	139,10							

Addebito cassa leggera (max7pz) (prezzo netto) / Light crate charge (max7pz) (net price) / Débit de caisse (max7pz) (prix net) / Kasse belasten (max7pz) (Nettopreis) - € 100
 Addebito cassa (prezzo netto) / Crate charge (net price) / Palette supplémentaire (prix net) / Aufreispalette (Nettopreis) - € 160
 Addebito cavalletto 18pz (prezzo netto) / Extra rack 18pcs (net price) / Chevalet supplémentaire 18pcs (prix net) / Aufpreisgestell 18St (Nettopreis) - € 270
 Addebito cavalletto 42pz (prezzo netto) / Extra rack 42pcs (net price) / Chevalet supplémentaire 42pcs (prix net) / Aufpreisgestell 42St (Nettopreis) - € 270

120x278 (48"x110") (119,5x278)* - 6 mm - Rettificato - KIT

✕ Silky

JN2K	VER. BARDIGLIO SILVER - SEAMLESS MATCH - 4PZ	2552,30	COMP.	1	13,34	49,56	59,80	990,08	1
JN3K	VER. FIORITO IVORY - SEAMLESS MATCH - 4PZ	2552,30							
JN1K	VER. NUVOLATO GREY - SEAMLESS MATCH - 4PZ	2552,30							

Addebito cassa leggera (max7pz) (prezzo netto) / Light crate charge (max7pz) (net price) / Débit de caisse (max7pz) (prix net) / Kasse belasten (max7pz) (Nettopreis) - € 100
 Addebito cassa (prezzo netto) / Crate charge (net price) / Palette supplémentaire (prix net) / Aufreispalette (Nettopreis) - € 160
 Addebito cavalletto 18pz (prezzo netto) / Extra rack 18pcs (net price) / Chevalet supplémentaire 18pcs (prix net) / Aufpreisgestell 18St (Nettopreis) - € 270
 Addebito cavalletto 42pz (prezzo netto) / Extra rack 42pcs (net price) / Chevalet supplémentaire 42pcs (prix net) / Aufpreisgestell 42St (Nettopreis) - € 270

120x120 (48"x48") (119,5x119,5)* - 9 mm - Rettificato

✕ Silky

JN2C	VERSILIA BARDIGLIO SILVER	118,50	MQ	2	2,86	60,80	57,12	1.251,00	20
JN3C	VERSILIA FIORITO IVORY	118,50							
JN1C	VERSILIA NUVOLATO GREY	118,50							

VERSILIA

Size	Code	Colour	Euro	U.M.	Pcs / Box	Mq / Box	Kg / Box	Mq / Pallet	Kg / Pallet	Box / Pallet
------	------	--------	------	------	-----------	----------	----------	-------------	-------------	--------------

VERSILIA

EFFETTO MARMO - MARBLE EFFECT - EFFET MARBRE - MARMOR EFFEKT

60x120 (24"x48") - 9 mm - Rettificato

◆ Lappato

D2JN	VERSILIA BARDIGLIO SILVER		111,80	MQ	2	1,44	31,93	50,40	1.138,00	15
D3JN	VERSILIA FIORITO IVORY		111,80							
D1JN	VERSILIA NUVOLATO GREY		111,80							

✕ Silky

JN2D	VERSILIA BARDIGLIO SILVER		91,20							
JN3D	VERSILIA FIORITO IVORY		91,20							
JN1D	VERSILIA NUVOLATO GREY		91,20							

□ Spazzolato R10

JND2	VERSILIA BARDIGLIO SILVER		86,00							
JND3	VERSILIA FIORITO IVORY		86,00							
JND1	VERSILIA NUVOLATO GREY		86,00							

60x60 (24"x24") - 9 mm - Rettificato

✕ Silky

JN2H	VERSILIA BARDIGLIO SILVER		64,90	MQ	3	1,08	21,00	43,20	853,00	40
JN3H	VERSILIA FIORITO IVORY		64,90							
JN1H	VERSILIA NUVOLATO GREY		64,90							

60x120 (24"x48") - 20 mm - Rettificato

▲ Structured R11

JNW2	VERSILIA BARDIGLIO SILVER		122,10	MQ	1	0,72	33,75	25,20	1.202,25	35
JNW3	VERSILIA FIORITO IVORY		122,10							
JNW1	VERSILIA NUVOLATO GREY		122,10							

60x120 (24"x48") Flute 3D - 9 mm - Rettificato

■ 3D

JNB2	VERSILIA BARDIGLIO SILVER		91,70	MQ	2	1,44	31,93	50,40	1.138,00	36
JNB3	VERSILIA FIORITO IVORY		91,70							
JNB1	VERSILIA NUVOLATO GREY		91,70							

VERSILIA

Size	Code	Colour	Euro	U.M.	Pcs / Box	Mq / Box	Kg / Box	Mq / Pallet	Kg / Pallet	Box / Pallet
------	------	--------	------	------	-----------	----------	----------	-------------	-------------	--------------

VERSILIA

EFFETTO MARMO - MARBLE EFFECT - EFFET MARBRE - MARMOR EFFEKT

20x120 (8"x48") Plisse - 9 mm - Rettificato

✕ Silky

JN2L	VERSILIA BARDIGLIO SILVER		38,60	PZ	4	0,96	20,66	34,56	756,76	36
JN3L	VERSILIA FIORITO IVORY		38,60		Venduti solo a scatole complete / Only full boxes sold / Vendus par boîte complete / Nur volle Karton					
JN1L	VERSILIA NUVOLATO GREY		38,60							

18,4x120 (7"x48") Plisse 3D - 9 mm - Rettificato

✕ Silky

JNL2	VERSILIA BARDIGLIO SILVER		64,90	PZ	3	0,66	14,25	23,76	526,00	36
JNL3	VERSILIA FIORITO IVORY		64,90		Venduti solo a scatole complete / Only full boxes sold / Vendus par boîte complete / Nur volle Karton					
JNL1	VERSILIA NUVOLATO GREY		64,90							

28,5x55,5 (11"x22") Biscuits - 9 mm - Rettificato

✕ Silky

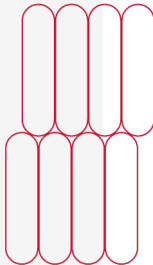
JN2P	VERSILIA BARDIGLIO SILVER		38,60	PZ	6	0,95	20,40	41,80	911,00	44
JN3P	VERSILIA FIORITO IVORY		38,60		Venduti solo a scatole complete / Only full boxes sold / Vendus par boîte complete / Nur volle Karton					
JN1P	VERSILIA NUVOLATO GREY		38,60							

30x30 (12"x12") Mosaico T100 (2,8x2,8) - 9 mm - Rettificato

✕ Silky

M2JN	VERSILIA BARDIGLIO SILVER		27,80	PZ	6	0,54	11,20	25,00	550,60	48
M3JN	VERSILIA FIORITO IVORY		27,80		Venduti solo a scatole complete / Only full boxes sold / Vendus par boîte complete / Nur volle Karton					
M1JN	VERSILIA NUVOLATO GREY		27,80							

30x30 (12"x12") Mosaico listelli - 9 mm - Rettificato

✕ Silky

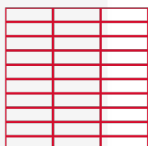
JN2M	VERSILIA BARDIGLIO SILVER		20,60	PZ	11	0,99	19,25	35,64	706,00	36
JN3M	VERSILIA FIORITO IVORY		20,60		Venduti solo a scatole complete / Only full boxes sold / Vendus par boîte complete / Nur volle Karton					
JN1M	VERSILIA NUVOLATO GREY		20,60							

VERSILIA

Size	Code	Colour	Euro	U.M.	Pcs / Box	Mq / Box	Kg / Box	Mq / Pallet	Kg / Pallet	Box / Pallet
------	------	--------	------	------	-----------	----------	----------	-------------	-------------	--------------

VERSILIA

EFFETTO MARMO - MARBLE EFFECT - EFFET MARBRE - MARMOR EFFEKT

33x120x4 (13"x48") Scalino incollato - 9 mm - Rettificato

◆ Lappato

Q2JN	VERSILIA BARDIGLIO SILVER	235,40	PZ	2	0,79	18,40	19,01	454,60	24
Q3JN	VERSILIA FIORITO IVORY	235,40							
Q1JN	VERSILIA NUVOLATO GREY	235,40							

Lavorato su richiesta e venduto solo a scatole complete / Manufactured upon request and only full boxes sold / Seulement à la demande et vendus par boîte complete / Nur auf Anfrage und nur volle Karton

✕ Silky

JN2Q	VERSILIA BARDIGLIO SILVER	235,40							
JN3Q	VERSILIA FIORITO IVORY	235,40							
JN1Q	VERSILIA NUVOLATO GREY	235,40							

□ Spazzolato R10

JNQ2	VERSILIA BARDIGLIO SILVER	235,40							
JNQ3	VERSILIA FIORITO IVORY	235,40							
JNQ1	VERSILIA NUVOLATO GREY	235,40							

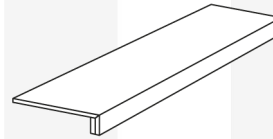

33x120x4 (13"x48") Scalino angolare incollato - 9 mm - Rettificato

◆ Lappato

X2JN	VERSILIA BARDIGLIO SILVER ANG. DX	258,50	PZ	1	0,40	9,00	9,50	238,60	200
Y2JN	VERSILIA BARDIGLIO SILVER ANG. SX	258,50							
X3JN	VERSILIA FIORITO IVORY ANG. DX	258,50							
Y3JN	VERSILIA FIORITO IVORY ANG. SX	258,50							
X1JN	VERSILIA NUVOLATO GREY ANG. DX	258,50							
Y1JN	VERSILIA NUVOLATO GREY ANG. SX	258,50							

Lavorato su richiesta e venduto solo a scatole complete / Manufactured upon request and only full boxes sold / Seulement à la demande et vendus par boîte complete / Nur auf Anfrage und nur volle Karton

✕ Silky

JN2X	VERSILIA BARDIGLIO SILVER ANG. DX	258,50							
JN2Y	VERSILIA BARDIGLIO SILVER ANG. SX	258,50							
JN3X	VERSILIA FIORITO IVORY ANG. DX	258,50							
JN3Y	VERSILIA FIORITO IVORY ANG. SX	258,50							
JN1X	VERSILIA NUVOLATO GREY ANG. DX	258,50							
JN1Y	VERSILIA NUVOLATO GREY ANG. SX	258,50							

□ Spazzolato R10

JNX2	VERSILIA BARDIGLIO SILVER ANG. DX	258,50							
JNY2	VERSILIA BARDIGLIO SILVER ANG. SX	258,50							
JNX3	VERSILIA FIORITO IVORY ANG. DX	258,50							
JNY3	VERSILIA FIORITO IVORY ANG. SX	258,50							
JNX1	VERSILIA NUVOLATO GREY ANG. DX	258,50							
JNY1	VERSILIA NUVOLATO GREY ANG. SX	258,50							

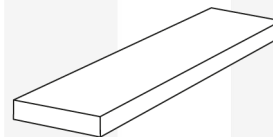

Size	Code	Colour	Euro	U.M.	Pcs / Box	Mq / Box	Kg / Box	Mq / Pallet	Kg / Pallet	Box / Pallet
------	------	--------	------	------	--------------	-------------	-------------	----------------	----------------	-----------------

VERSILIA

EFFETTO MARMO - MARBLE EFFECT - EFFET MARBRE - MARMOR EFFEKT

4,6x120 (1.80"x48") Battiscopa - 9 mm - Rettificato

◆ Lappato

				Mt					
R2JN	VERSILIA BARDIGLIO SILVER	24,70	PZ	6	7,20	7,80	345,60	387,40	48
R3JN	VERSILIA FIORITO IVORY	24,70		Venduti solo a scatole complete / Only full boxes sold / Vendus par boîte complete / Nur volle Karton					
R1JN	VERSILIA NUVOLATO GREY	24,70							

✕ Silky

JN2R	VERSILIA BARDIGLIO SILVER	24,70							
JN3R	VERSILIA FIORITO IVORY	24,70							
JN1R	VERSILIA NUVOLATO GREY	24,70							

□ Spazzolato R10

JNR2	VERSILIA BARDIGLIO SILVER	24,70							
JNR3	VERSILIA FIORITO IVORY	24,70							
JNR1	VERSILIA NUVOLATO GREY	24,70							



VERSILIA

Size	Code	Colour	Euro	U.M.	Pcs / Box	Mq / Box	Kg / Box	Mq / Pallet	Kg / Pallet	Box / Pallet
------	------	--------	------	------	-----------	----------	----------	-------------	-------------	--------------

DUNSTONE

EFFETTO PIETRA - STONE EFFECT - EFFET PIERRE - STEIN EFFEKT

60x60 (24"x24") - 8,5 mm - Rettificato

● Natural R9

E9H3	DUNSTONE BEIGE	42,30	MQ	3	1,08	20,87	43,20	850,80	40
E9H2	DUNSTONE GREY	42,30							
E9H1	DUNSTONE IVORY	42,30							

30x60 (12"x24") - 8,5 mm - Rettificato

● Natural R9

E9I3	DUNSTONE BEIGE	40,10	MQ	7	1,26	24,35	50,40	990,00	40
E9I2	DUNSTONE GREY	40,10							
E9I1	DUNSTONE IVORY	40,10							

DUNSTONE

60x120 (24"x48") - 9 mm - Rettificato

● Natural R9

E9D3	DUNSTONE BEIGE	62,30	MQ	2	1,44	31,93	50,40	1.138,00	35
E9D2	DUNSTONE GREY	62,30							
E9D1	DUNSTONE IVORY	62,30							

33x60x4 (13"x24") Scalino incollato - 8,5 mm - Rettificato

● Natural R9

E9S3	DUNSTONE BEIGE	107,40	PZ	4	0,79	21,70	19,01	533,80	24
E9S2	DUNSTONE GREY	107,40							
E9S1	DUNSTONE IVORY	107,40							

33x33x4 (13"x13") Scalino angolare incollato - 8,5 mm - Rettificato

● Natural R9

E9V3	DUNSTONE BEIGE	131,80	PZ	4	0,44	14,48	13,07	447,40	30
E9V2	DUNSTONE GREY	131,80							
E9V1	DUNSTONE IVORY	131,80							

Size	Code	Colour	Euro	U.M.	Pcs / Box	Mq / Box	Kg / Box	Mq / Pallet	Kg / Pallet	Box / Pallet
------	------	--------	------	------	-----------	----------	----------	-------------	-------------	--------------

DUNSTONE

EFFETTO PIETRA - STONE EFFECT - EFFET PIERRE - STEIN EFFEKT

33x120x4 (13"x48") Scalino incollato - 9 mm - Rettificato

● Natural R9

E9Q3	DUNSTONE BEIGE	224,00	PZ	2	0,79	18,40	19,01	454,60	24
E9Q2	DUNSTONE GREY	224,00							
E9Q1	DUNSTONE IVORY	224,00							

Lavorato su richiesta e venduto solo a scatole complete / Manufactured upon request and only full boxes sold / Seulement à la demande et vendus par boîte complete / Nur auf Anfrage und nur volle Karton

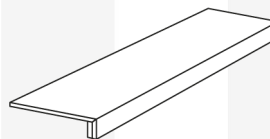

33x120x4 (13"x48") Scalino angolare incollato - 9 mm - Rettificato

● Natural R9

E9X3	DUSTONE BEIGE ANG. DX	245,80	PZ	1	0,40	9,00	9,50	238,60	24
E9Y3	DUSTONE BEIGE ANG. SX	245,80							
E9X2	DUSTONE GREY ANG. DX	245,80							
E9Y2	DUSTONE GREY ANG. SX	245,80							
E9X1	DUSTONE IVORY ANG. DX	245,80							
E9Y1	DUSTONE IVORY ANG. SX	245,80							

Lavorato su richiesta e venduto solo a scatole complete / Manufactured upon request and only full boxes sold / Seulement à la demande et vendus par boîte complete / Nur auf Anfrage und nur volle Karton

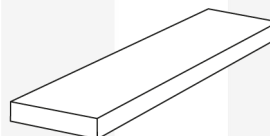

7,2x60 (2.80"x24") Battiscopa - 8,5 mm - Rettificato

● Natural R9

E9R3	DUNSTONE BEIGE	10,60	PZ	10	Mt	6,00	10,48	480,00	836,00	80
E9R2	DUNSTONE GREY	10,60								
E9R1	DUNSTONE IVORY	10,60								



DUNSTONE

Size	Code	Colour	Euro	U.M.	Pcs / Box	Mq / Box	Kg / Box	Mq / Pallet	Kg / Pallet	Box / Pallet
------	------	--------	------	------	--------------	-------------	-------------	----------------	----------------	-----------------

EXTREME

EFFETTO PIETRA - STONE EFFECT - EFFET PIERRE - STEIN EFFEKT

45x90 (18"x36") - 20 mm - Rettificato

▲ Structured R11

BNY3	EXTREME ANTHRACITE	90,80	MQ	2	0,81	37,40	21,87	1.027,80	27
BNY1	EXTREME BEIGE	90,80							
BNY2	EXTREME GREY	90,80							

60x60 (24"x24") - 20 mm - Rettificato

▲ Structured R11

BNW3	EXTREME ANTHRACITE	85,80	MQ	2	0,72	30,70	21,60	934,00	30
BNW1	EXTREME BEIGE	85,80							
BNW2	EXTREME GREY	85,80							

EXTREME

Size	Code	Colour	Euro	U.M.	Pcs / Box	Mq / Box	Kg / Box	Mq / Pallet	Kg / Pallet	Box / Pallet
------	------	--------	------	------	--------------	-------------	-------------	----------------	----------------	-----------------

LONDALE

EFFETTO CEMENTO - CONCRETE EFFECT - EFFET CIMENT - ZEMENT EFFEKT

60x60 (24"x24") - 8,5 mm - Rettificato

● Natural R9

E8H2	LONDALE BEIGE	42,60	MQ	3	1,08	20,87	43,20	850,80	40
E8H3	LONDALE GREY	42,60							
E8H1	LONDALE SILVER	42,60							

30x60 (12"x24") - 8,5 mm - Rettificato

● Natural R9

E8I2	LONDALE BEIGE	40,40	MQ	7	1,26	24,35	50,40	990,00	40
E8I3	LONDALE GREY	40,40							
E8I1	LONDALE SILVER	40,40							

60x120 (24"x48") - 9 mm - Rettificato

● Natural R9

E8D2	LONDALE BEIGE	62,70	MQ	2	1,44	31,93	50,40	1.138,00	35
E8D3	LONDALE GREY	62,70							
E8D1	LONDALE SILVER	62,70							

33x60x4 (13"x24") Scalino incollato - 8,5 mm - Rettificato

● Natural R9

E8S2	LONDALE BEIGE	107,40	PZ	4	0,79	21,70	19,01	533,80	24
E8S3	LONDALE GREY	107,40							
E8S1	LONDALE SILVER	107,40							

33x33x4 (13"x13") Scalino angolare incollato - 8,5 mm - Rettificato

● Natural R9

E8V2	LONDALE BEIGE	131,80	PZ	4	0,44	14,48	13,07	447,40	30
E8V3	LONDALE GREY	131,80							
E8V1	LONDALE SILVER	131,80							

LONDALE

Size	Code	Colour	Euro	U.M.	Pcs / Box	Mq / Box	Kg / Box	Mq / Pallet	Kg / Pallet	Box / Pallet
------	------	--------	------	------	-----------	----------	----------	-------------	-------------	--------------

LONDALE

EFFETTO CEMENTO - CONCRETE EFFECT - EFFET CIMENT - ZEMENT EFFEKT

33x120x4 (13"x48") Scalino incollato - 9 mm - Rettificato

● Natural R9

E8Q2	LONDALE BEIGE	224,00	PZ	2	0,79	18,40	19,01	454,60	24
E8Q3	LONDALE GREY	224,00							
E8Q1	LONDALE SILVER	224,00							

Lavorato su richiesta e venduto solo a scatole complete / Manufactured upon request and only full boxes sold / Seulement à la demande et vendus par boîte complete / Nur auf Anfrage und nur volle Karton

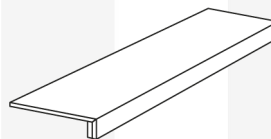

33x120x4 (13"x48") Scalino angolare incollato - 9 mm - Rettificato

● Natural R9

E8X2	LONDALE BEIGE ANG. DX	245,80	PZ	1	0,40	9,00	9,50	238,60	24
E8Y2	LONDALE BEIGE ANG. SX	245,80							
E8X3	LONDALE GREY ANG. DX	245,80							
E8Y3	LONDALE GREY ANG. SX	245,80							
E8Y1	LONDALE SILVER ANG. DX	245,80							
E8X1	LONDALE SILVER ANG. SX	245,80							

Lavorato su richiesta e venduto solo a scatole complete / Manufactured upon request and only full boxes sold / Seulement à la demande et vendus par boîte complete / Nur auf Anfrage und nur volle Karton

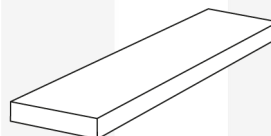

LONDALE

7,2x60 (2.80"x24") Battiscopa - 8,5 mm - Rettificato

● Natural R9

E8R2	LONDALE BEIGE	10,60	PZ	10	Mt	6,00	10,48	480,00	836,00	80
E8R3	LONDALE GREY	10,60								
E8R1	LONDALE SILVER	10,60								



Size	Code	Colour	Euro	U.M.	Pcs / Box	Mq / Box	Kg / Box	Mq / Pallet	Kg / Pallet	Box / Pallet
------	------	--------	------	------	-----------	----------	----------	-------------	-------------	--------------

POINT

EFFETTO PIETRA - STONE EFFECT - EFFET PIERRE - STEIN EFFEKT

30x60 (12"x24") - 8,5 mm - Rettificato

▲ Structured R11

Y92T	POINT BEIGE MULTICOLOR	43,00	MQ	7	1,26	24,35	50,40	990,00	40
Y93T	POINT GREY MULTICOLOR	43,00							
Y91T	POINT SAND	42,00							
Y94T	POINT SILVER	42,00							

16,5x30x3,8 Terminale L monolitico - 10 mm - Non rettificato

▲ Structured R11

Y9e2	POINT BEIGE MULTICOLOR	19,10	PZ	10	0,495		16,34	442,00	33
Y9e3	POINT GREY MULTICOLOR	19,10							
Y9e1	POINT SAND	19,10							
Y9e4	POINT SILVER	19,10							

8x30 (3.15 "x12") Battiscopa - 8,5 mm - Non rettificato

▲ Structured R11

Y9X2	POINT BEIGE MULTICOLOR	4,20	PZ	33	Mt 9,90	14,26	0,00	1.101,00	64
Y9X3	POINT GREY MULTICOLOR	4,20							
Y9X1	POINT SAND	4,20							
Y9X4	POINT SILVER	4,20							

POINT

Size	Code	Colour	Euro	U.M.	Pcs / Box	Mq / Box	Kg / Box	Mq / Pallet	Kg / Pallet	Box / Pallet
------	------	--------	------	------	--------------	-------------	-------------	----------------	----------------	-----------------

SWISSTONE

EFFETTO PIETRA - STONE EFFECT - EFFET PIERRE - STEIN EFFEKT

60x60 (24"x24") - 20 mm - Rettificato

▲ Structured R11

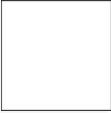
FBW1	SWISSTONE ANTHRACITE	81,80	MQ	2	0,72	30,70	21,60	934,00	30
FBW2	SWISSTONE GREY	81,80							

SWISSTONE

Size	Code	Colour	Euro	U.M.	Pcs / Box	Mq / Box	Kg / Box	Mq / Pallet	Kg / Pallet	Box / Pallet
------	------	--------	------	------	-----------	----------	----------	-------------	-------------	--------------

SYNTECH

EFFETTO RESINA - RESIN EFFECT - EFFET RÉSINE - HARZ EFFEKT

60x60 (24"x24") - 8,5 mm - Rettificato

● Natural R9

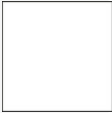
IDH2	SYNTECH BEIGE	42,70	MQ	3	1,08	20,87	43,20	850,80	40
IDH3	SYNTECH SILVER	42,70							
IDH4	SYNTECH TAUPE	42,70							
IDH1	SYNTECH WHITE	42,70							

30x60 (12"x24") - 8,5 mm - Rettificato

● Natural R9

IDI2	SYNTECH BEIGE	40,20	MQ	7	1,26	24,35	50,40	990,00	40
IDI3	SYNTECH SILVER	40,20							
IDI4	SYNTECH TAUPE	40,20							
IDI1	SYNTECH WHITE	40,20							

60x120 (24"x48") - 9 mm - Rettificato

● Natural R9

IDD2	SYNTECH BEIGE	62,80	MQ	2	1,44	31,93	50,40	1.138,00	35
IDD3	SYNTECH SILVER	62,80							
IDD4	SYNTECH TAUPE	62,80							
IDD1	SYNTECH WHITE	62,80							

33x60x4 (13"x24") Scalino incollato - 8,5 mm - Rettificato

● Natural R9

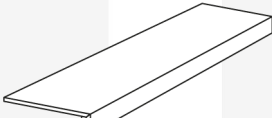
ID2S	SYNTECH BEIGE	107,60	PZ	4	0,79	21,70	19,01	533,80	24
ID3S	SYNTECH SILVER	107,60							
IDS4	SYNTECH TAUPE	107,60							
IDS1	SYNTECH WHITE	107,60							

33x33x4 (13"x13") Scalino angolare incollato - 8,5 mm - Rettificato

● Natural R9

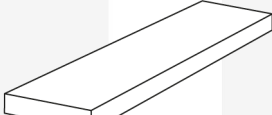
IDV2	SYNTECH BEIGE	131,80	PZ	4	0,44	14,48	13,07	447,40	30
IDV3	SYNTECH SILVER	131,80							
IDV4	SYNTECH TAUPE	131,80							
IDV1	SYNTECH WHITE	131,80							

SYNTECH

Size	Code	Colour	Euro	U.M.	Pcs / Box	Mq / Box	Kg / Box	Mq / Pallet	Kg / Pallet	Box / Pallet
------	------	--------	------	------	-----------	----------	----------	-------------	-------------	--------------

SYNTECH

EFFETTO RESINA - RESIN EFFECT - EFFET RÉSINE - HARZ EFFEKT

33x120x4 (13"x48") Scalino incollato - 9 mm - Rettificato

● Natural R9

IDQ2	SYNTECH BEIGE	224,00	PZ	2	0,79	18,40	19,01	454,60	24
IDQ3	SYNTECH SILVER	224,00							
IDQ4	SYNTECH TAUPE	224,00							
IDQ1	SYNTECH WHITE	224,00							

Lavorato su richiesta e venduto solo a scatole complete / Manufactured upon request and only full boxes sold / Seulement à la demande et vendus par boîte complete / Nur auf Anfrage und nur volle Karton

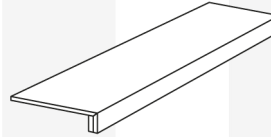

33x120x4 (13"x48") Scalino angolare incollato - 9 mm - Rettificato

● Natural R9

IDX2	SYNTECH BEIGE ANG. DX	245,70	PZ	1	0,40	9,00	9,50	238,60	200
IDY2	SYNTECH BEIGE ANG. SX	245,70							
IDX3	SYNTECH SILVER ANG. DX	245,70							
IDY3	SYNTECH SILVER ANG. SX	245,70							
IDX4	SYNTECH TAUPE ANG. DX	245,70							
IDY4	SYNTECH TAUPE ANG. SX	245,70							
IDX1	SYNTECH WHITE ANG. DX	245,70							
IDY1	SYNTECH WHITE ANG. SX	245,70							

Lavorato su richiesta e venduto solo a scatole complete / Manufactured upon request and only full boxes sold / Seulement à la demande et vendus par boîte complete / Nur auf Anfrage und nur volle Karton

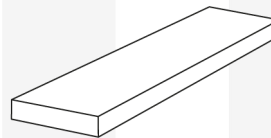

7,2x60 (2.80"x24") Battiscopa - 8,5 mm - Rettificato

● Natural R9

IDR2	SYNTECH BEIGE	10,80	PZ	10	Mt 6,00	10,48	480,00	836,00	80
IDR3	SYNTECH SILVER	10,80							
IDR4	SYNTECH TAUPE	10,80							
IDR1	SYNTECH WHITE	10,80							

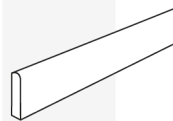

SYNTECH

Size	Code	Colour	Euro	U.M.	Pcs / Box	Mq / Box	Kg / Box	Mq / Pallet	Kg / Pallet	Box / Pallet
------	------	--------	------	------	-----------	----------	----------	-------------	-------------	--------------

URBAN

EFFETTO CEMENTO - CONCRETE EFFECT - EFFET CIMENT - ZEMENT EFFEKT

60x60 (24"x24") - 8,5 mm - Rettificato

■ Grip R10

DP3H	URBAN ANTHRACITE	42,40	MQ	3	1,08	20,87	43,20	850,80	40
DP2H	URBAN GREY	42,40							
DP1H	URBAN IVORY	42,40							

30x60 (12"x24") - 8,5 mm - Rettificato

■ Grip R10

DP3I	URBAN ANTHRACITE	40,20	MQ	7	1,26	24,35	50,40	990,00	40
DP2I	URBAN GREY	40,20							
DP1I	URBAN IVORY	40,20							

7,2x60 (2.80"x24") Battiscopa - 8,5 mm - Rettificato

■ Grip R10

DP3R	URBAN ANTHRACITE	10,60	PZ	10	Mt 6,00	10,48	480,00	851,40	80
DP2R	URBAN GREY	10,60							
DP1R	URBAN IVORY	10,60							

URBAN

OUTDOOR 20MM

Size	Code	Colour	Euro	U.M.	Pcs / Box	Mq / Box	Kg / Box	Mq / Pallet	Kg / Pallet	Box / Pallet
------	------	--------	------	------	-----------	----------	----------	-------------	-------------	--------------

20MM

120x240 (48"x96") (119,5x239)* - 20 mm - Rettificato

▲ Structured R11

PERCORSI EXTRA

L16J	PERCORSI EXTRA PIETRA DI VALS	194,10	MQ	1	2,86	134,20	25,70	1.302,80	9
------	-------------------------------	--------	----	---	------	--------	-------	----------	---

PERCORSI SMART

S671	PERCORSI SMART PIETRA DI BAGNOLO	188,20							
S672	PERCORSI SMART PIETRA DI BRESSA	190,90							
S674	PERCORSI SMART PIETRA DI LAVIS	190,90							

Addebito pallet (prezzo netto) / Extra pallet (net price) / Palette supplémentaire (prix net) / Aufpreispalette (Nettopreis) - € 140

30x240 (12"x96") (30x239)* - 20 mm - Rettificato

▲ Structured R11

PERCORSI SMART

S6a1	PERCORSI SMART PIETRA DI BAGNOLO	223,70	MQ	1	0,72	31,00	25,81	1.211,00	36
S6a2	PERCORSI SMART PIETRA DI BRESSA	226,90							
S6a4	PERCORSI SMART PIETRA DI LAVIS	226,90							

Addebito pallet (prezzo netto) / Extra pallet (net price) / Palette supplémentaire (prix net) / Aufpreispalette (Nettopreis) - € 140

Ordine minimo 25,81 mq / Minimum order quantity 25,81 sqm / Commande minimum 25,81 Mq / Mindestbestellmenge 25,81 Mq

20MM

Size	Code	Colour	Euro	U.M.	Pcs / Box	Mq / Box	Kg / Box	Mq / Pallet	Kg / Pallet	Box / Pallet
------	------	--------	------	------	--------------	-------------	-------------	----------------	----------------	-----------------

20MM

120x120 (48"x48") - 20 mm - Rettificato

▲ Grip R11

MOOV

Y58Y	MOOV ANTHRACITE	146,20	MQ	1	1,43	67,10	28,56	1.377,00	20
Y85Y	MOOV GREY	138,90							
Y86Y	MOOV MOKA	146,20							

NOORD

1YED	NOORD GREY	140,20							
5YED	NOORD WHITE	140,20							

▲ Structured R11

DOLMIX

W1FF	DOLMIX GREY	141,20							
------	-------------	--------	--	--	--	--	--	--	--

GEO

3WHJ	GEO BEIGE	143,60							
5WHJ	GEO GREY	138,10							
2WHJ	GEO IVORY	143,60							
4WHJ	GEO SILVER	138,10							

PERCORSI EXTRA

J61Y	PERCORSI EXTRA PIETRA DI BARGE	140,30							
S62Y	PERCORSI EXTRA PIETRA DI VALS	144,80							

20MM

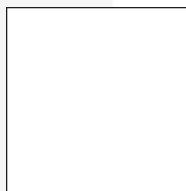

Size	Code	Colour	Euro	U.M.	Pcs / Box	Mq / Box	Kg / Box	Mq / Pallet	Kg / Pallet	Box / Pallet
------	------	--------	------	------	--------------	-------------	-------------	----------------	----------------	-----------------

20MM

60x120 (24"x48") - 20 mm - Rettificato

▲ Grip R11

CHORUS

C086	CHORUS BEIGE		116,80	MQ	1	0,72	33,75	25,20	1.202,25	35
C054	CHORUS SILVER		116,80							
C048	CHORUS WHITE		120,30							

▲ Structured R11

ARKE

I6W1	ARKE ANTHRACITE		110,20							
I6W4	ARKE BEIGE		112,30							
I6W3	ARKE CLAY		110,20							
I6W2	ARKE GREY		110,20							
I6W5	ARKE IVORY		112,30							

GEO

HJW3	GEO BEIGE		121,50							
HJW5	GEO GREY		116,80							
HJW2	GEO IVORY		121,50							
HJW4	GEO SILVER		116,80							

HERITAGE

IJW3	HERITAGE BEIGE		121,50							
IJW4	HERITAGE GREY		121,50							
IJW2	HERITAGE IVORY		121,50							
IJW1	HERITAGE PEARL		121,50							

LAVICA

JMW5	LAVICA ANTHRACITE		121,50							
JMW4	LAVICA GREY		121,50							

OMNIA

GKW4	OMNIA CEPPO GREY		116,80							
GKW5	OMNIA DEVIX GREIGE		116,80							
GKW1	OMNIA EMPERADOR WHITE		121,70							
GKW6	OMNIA RAPOLANO BEIGE		121,70							
GKW8	OMNIA ROMANO SAND		121,70							
GKW7	OMNIA TIVOLI IVORY		121,70							
GKW2	OMNIA VENEZIA IVORY		121,70							

PERCORSI EXTRA

J691	PERCORSI EXTRA PIETRA DI BARGE		120,80							
J694	PERCORSI EXTRA PIETRA DI VALS		124,40							

PERCORSI FRAME

20MM

Size	Code	Colour	Euro	U.M.	Pcs / Box	Mq / Box	Kg / Box	Mq / Pallet	Kg / Pallet	Box / Pallet
------	------	--------	------	------	--------------	-------------	-------------	----------------	----------------	-----------------

20MM

GJW2	PERCORSI FRAME GNEISS GREY		118,00							
GJW3	PERCORSI FRAME IMPERIALE WALNUT		122,70							
GJW1	PERCORSI FRAME PLIMA SILVER		118,00							
GJW5	PERCORSI FRAME TRAVERTINO BEIGE		122,70							

UBIK

FGW1	UBIK ANTHRACITE		122,10							
FGW3	UBIK GREIGE		117,10							
FGW2	UBIK GREY		117,10							
FGW4	UBIK IVORY		122,10							
FGW5	UBIK WALNUT		122,10							

VERSILIA

JNW2	VERSILIA BARDIGLIO SILVER		122,10							
JNW3	VERSILIA FIORITO IVORY		122,10							
JNW1	VERSILIA NUVOLATO GREY		122,10							

30x120 (12"x48") - 20 mm - Rettificato

▲ Structured R11

EVOKE

Q7W2	EVOKE BROWN		137,00	MQ	2	0,72	33,05	25,92	1.203,00	36
Q7W4	EVOKE SAND		137,00							

JOURNEY

HS4W	JOURNEY BONE		132,90							
HSW2	JOURNEY HONEY		138,30							

SOUL

V952	SOUL GREY		139,30							
V954	SOUL WALNUT		135,40							

90x90 (36"x36") - 20 mm - Rettificato

▲ Grip R11

MOOV

W5Y8	MOOV ANTHRACITE		130,50	MQ	1	0,81	38,00	14,58	699,00	18
W2Y8	MOOV BEIGE		127,70							
W3Y8	MOOV GREY		127,70							
W4Y8	MOOV MOKA		130,50							

Size	Code	Colour	Euro	U.M.	Pcs / Box	Mq / Box	Kg / Box	Mq / Pallet	Kg / Pallet	Box / Pallet
------	------	--------	------	------	-----------	----------	----------	-------------	-------------	--------------

20MM

60x90 (24"x36") - 20 mm - Rettificato

▲ Structured R11

BRYSTONE

DYW2	BRYSTONE GOLD	108,70	MQ	2	1,08	48,50	25,92	1.182,00	24
DYW1	BRYSTONE GREY	108,70							
DYW3	BRYSTONE IVORY	112,20							

Disponibile anche con palletizzazione a 18 scatole. Verificare all'ordine la disponibilità / Also available with 18 boxes palletization. Check availability when ordering / Egalement disponible avec une palettisation de 18 caisses. Vérifier la disponibilité lors de la commande / Auch mit 18 Kartons Palettierung erhältlich. Verfügbarkeit bei Bestellung prüfen

MIDLAKE

D204	MIDLAKE ARDESIA	110,70							
D202	MIDLAKE PORFIDO	107,30							
D203	MIDLAKE QUARTZBEIGE	107,30							
D201	MIDLAKE QUARTZGREY	110,70							

45x90 (18"x36") - 20 mm - Rettificato

▲ Structured R11

EXTREME

BNY3	EXTREME ANTHRACITE	90,80	MQ	2	0,81	37,40	21,87	1.027,80	27
BNY1	EXTREME BEIGE	90,80							
BNY2	EXTREME GREY	90,80							

PERCORSI EXTRA

j6W1	PERCORSI EXTRA PIETRA DI BARGE	100,80							
j6W2	PERCORSI EXTRA PIETRA DI COMBE	100,80							
j6W3	PERCORSI EXTRA PIETRA DI FAEDIS	104,40							
j6W4	PERCORSI EXTRA PIETRA DI VALS	104,40							

PERCORSI SMART

s6W1	PERCORSI SMART PIETRA DI BAGNOLO	100,20							
S62S	PERCORSI SMART PIETRA DI BRESSA	103,70							
s6W4	PERCORSI SMART PIETRA DI LAVIS	103,70							

20MM

Size	Code	Colour	Euro	U.M.	Pcs / Box	Mq / Box	Kg / Box	Mq / Pallet	Kg / Pallet	Box / Pallet
------	------	--------	------	------	--------------	-------------	-------------	----------------	----------------	-----------------

20MM

80x80 (32"x32") - 20 mm - Rettificato

▲ Grip R11

NOORD

EDW4	NOORD ANTHRACITE	114,90	MQ	1	0,64	28,00	26,88	1.272,40	42
EDW1	NOORD GREY	117,50							
EDW5	NOORD WHITE	117,50							

▲ Structured R11

BRYSTONE

DY2W	BRYSTONE GOLD	114,90							
DY1W	BRYSTONE GREY	114,90							
DY5W	BRYSTONE WHITE	119,50							

DISTRICT

IBW1	DISTRICT GREIGE	114,80							
IBW5	DISTRICT GREY	114,80							
IBW3	DISTRICT IVORY	114,80							
IBW4	DISTRICT SILVER	114,80							
IBW2	DISTRICT WHITE	114,80							

20MM



Size	Code	Colour	Euro	U.M.	Pcs / Box	Mq / Box	Kg / Box	Mq / Pallet	Kg / Pallet	Box / Pallet
------	------	--------	------	------	--------------	-------------	-------------	----------------	----------------	-----------------

20MM

60x60 (24"x24") - 20 mm - Rettificato

▲ Grip R11

MOOV

Y8W5	MOOV ANTHRACITE	97,20	MQ	2	0,72	30,70	21,60	934,00	30
Y8w2	MOOV BEIGE	94,70							
Y8w3	MOOV GREY	94,70							
Y8w5	MOOV MOKA	97,20							

NOORD

4HED	NOORD ANTHRACITE	93,80							
3HED	NOORD GOLD	93,80							
1HED	NOORD GREY	95,80							
7HED	NOORD IVORY	95,80							
5HED	NOORD WHITE	95,80							

▲ Structured R11

DOLMIX

FF1W	DOLMIX GREY	94,90							
------	-------------	-------	--	--	--	--	--	--	--

EXTREME

BNW3	EXTREME ANTHRACITE	85,80							
BNW1	EXTREME BEIGE	85,80							
BNW2	EXTREME GREY	85,80							

PERCORSI EXTRA

J6w1	PERCORSI EXTRA PIETRA DI BARGE	97,00							
J6w2	PERCORSI EXTRA PIETRA DI COMBE	97,00							
J6w3	PERCORSI EXTRA PIETRA DI FAEDIS	100,30							
J6w4	PERCORSI EXTRA PIETRA DI VALS	100,30							
ZAw3	PERCORSI EXTRA SIGHT ANTHR.	99,70							

PERCORSI FRAME

GJ2W	PERCORSI FRAME GNEISS GREY	96,80							
GJ3W	PERCORSI FRAME IMPERIALE WALNUT	100,60							
GJ1W	PERCORSI FRAME PLIMA SILVER	96,80							
GJ5W	PERCORSI FRAME TRAVERTINO BEIGE	100,60							

PERCORSI SMART

S6w1	PERCORSI SMART PIETRA DI BAGNOLO	96,10							
S6w2	PERCORSI SMART PIETRA DI BRESSA	99,50							
S6w4	PERCORSI SMART PIETRA DI LAVIS	99,50							

SWISSTONE

FBW1	SWISSTONE ANTHRACITE	81,80							
FBW2	SWISSTONE GREY	81,80							

20MM

Size	Code	Colour	Euro	U.M.	Pcs / Box	Mq / Box	Kg / Box	Mq / Pallet	Kg / Pallet	Box / Pallet
------	------	--------	------	------	--------------	-------------	-------------	----------------	----------------	-----------------

20MM

	UBIK									
FG1W	UBIK ANTHRACITE		97,00							
FG3W	UBIK GREIGE		94,20							
FG2W	UBIK GREY		94,20							
FG4W	UBIK IVORY		97,00							
FG5W	UBIK WALNUT		97,00							



20MM

Size	Code	Colour	Euro	U.M.	Pcs / Box	Mq / Box	Kg / Box	Mq / Pallet	Kg / Pallet	Box / Pallet
------	------	--------	------	------	--------------	-------------	-------------	----------------	----------------	-----------------

20MM - PEZZI SPECIALI / TRIMS

GRADINO BORDO TORO 60x120 (24"x48") - 20 mm - Rettificato

▲ Grip R11

NOORD									
5DED	NOORD WHITE	177,10	PZ	1	0,72			0,00	999

Lavorato su richiesta. Disponibile in tutti i colori K2 delle seguenti serie / Manufactured upon request. Available in all K2 colors of the following collections / Seulement à la demande. Disponible dans toutes les couleurs K2 de la séries suivantes / Nur auf Anfrage. Erhältlich in allen K2 Farben der folgenden Serie

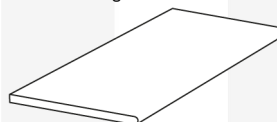

GRADINO BORDO TORO 30x120 (12"x48") - 20 mm - Rettificato

▲ Grip R11

NOORD									
EDB5	NOORD WHITE	162,20	PZ	2	0,72			0,00	999

Lavorato su richiesta. Disponibile in tutti i colori K2 delle seguenti serie / Manufactured upon request. Available in all K2 colors of the following collections / Seulement à la demande. Disponible dans toutes les couleurs K2 de la séries suivantes / Nur auf Anfrage. Erhältlich in allen K2 Farben der folgenden Serie

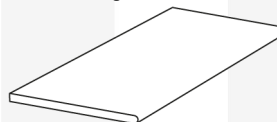

GRADINO BORDO TORO 40x80 (16"x32") - 20 mm - Rettificato

▲ Grip R11

NOORD									
B1ED	NOORD GREY	138,30	PZ	1	0,32			0,00	999
B5ED	NOORD WHITE	138,30							

Lavorato su richiesta. Disponibile in tutti i colori K2 delle seguenti serie / Manufactured upon request. Available in all K2 colors of the following collections / Seulement à la demande. Disponible dans toutes les couleurs K2 de la séries suivantes / Nur auf Anfrage. Erhältlich in allen K2 Farben der folgenden Serie

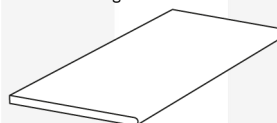

Size	Code	Colour	Euro	U.M.	Pcs / Box	Mq / Box	Kg / Box	Mq / Pallet	Kg / Pallet	Box / Pallet
------	------	--------	------	------	--------------	-------------	-------------	----------------	----------------	-----------------

20MM - PEZZI SPECIALI / TRIMS

GRADINO BORDO TORO 30x60 (12"x24") - 20 mm - Rettificato

▲ Grip R11

NOORD									
D4ED	NOORD ANTHRACITE	59,50	PZ	1	0,18			0,00	999
D1ED	NOORD GREY	59,50							
D5ED	NOORD WHITE	59,50							

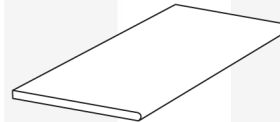

Lavorato su richiesta. Disponibile in tutti i colori K2 delle seguenti serie / Manufactured upon request. Available in all K2 colors of the following collections / Seulement à la demande. Disponible dans toutes les couleurs K2 de la séries suivantes / Nur auf Anfrage. Erhältlich in allen K2 Farben der folgenden Serie

TOP BORDO TORO 30x60 (12"x24") - 20 mm - Rettificato

▲ Grip R11

NOORD									
EDN1	NOORD GREY	131,80	PZ	1	0,18			0,00	999

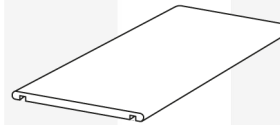

Lavorato su richiesta. Disponibile in tutti i colori K2 delle seguenti serie / Manufactured upon request. Available in all K2 colors of the following collections / Seulement à la demande. Disponible dans toutes les couleurs K2 de la séries suivantes / Nur auf Anfrage. Erhältlich in allen K2 Farben der folgenden Serie

ANGOLARE ESTERNO BORDO TORO 30x120 (12"x48") - 20 mm - Rettificato

▲ Grip R11

NOORD									
DXED	NOORD WHITE	191,00	PZ	2	0,63			0,00	999
SXED	NOORD WHITE	191,00							

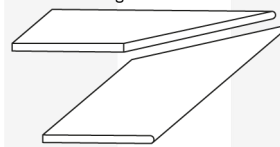

Lavorato su richiesta. Disponibile in tutti i colori K2 delle seguenti serie / Manufactured upon request. Available in all K2 colors of the following collections / Seulement à la demande. Disponible dans toutes les couleurs K2 de la séries suivantes / Nur auf Anfrage. Erhältlich in allen K2 Farben der folgenden Serie

ANGOLARE ESTERNO BORDO TORO 40x80 (16"x32") - 20 mm - Rettificato

▲ Grip R11

NOORD									
EDF1	NOORD GREY	185,70	PZ	1	0,24			0,00	999
H1ED	NOORD GREY	185,70							

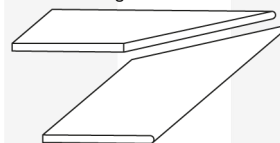

Lavorato su richiesta. Disponibile in tutti i colori K2 delle seguenti serie / Manufactured upon request. Available in all K2 colors of the following collections / Seulement à la demande. Disponible dans toutes les couleurs K2 de la séries suivantes / Nur auf Anfrage. Erhältlich in allen K2 Farben der folgenden Serie

Size	Code	Colour	Euro	U.M.	Pcs / Box	Mq / Box	Kg / Box	Mq / Pallet	Kg / Pallet	Box / Pallet
------	------	--------	------	------	-----------	----------	----------	-------------	-------------	--------------

20MM - PEZZI SPECIALI / TRIMS

ANGOLARE ESTERNO BORDO TORO 30x60 (12"x24") - 20 mm - Rettificato

▲ Grip R11

NOORD									
ED54	NOORD WHITE	81,20	PZ	1	0,14			0,00	999
ED45	NOORD WHITE	81,20							

Lavorato su richiesta. Disponibile in tutti i colori K2 delle seguenti serie / Manufactured upon request. Available in all K2 colors of the following collections / Seulement à la demande. Disponible dans toutes les couleurs K2 de la séries suivantes / Nur auf Anfrage. Erhältlich in allen K2 Farben der folgenden Serie

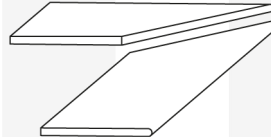

ANGOLARE INTERNO BORDO TORO 60x120 (24"x48") - 20 mm - Rettificato

▲ Grip R11

NOORD									
4SED	NOORD WHITE	234,80	PZ	1	0,54			0,00	999
4DED	NOORD WHITE	234,80							

Lavorato su richiesta. Disponibile in tutti i colori K2 delle seguenti serie / Manufactured upon request. Available in all K2 colors of the following collections / Seulement à la demande. Disponible dans toutes les couleurs K2 de la séries suivantes / Nur auf Anfrage. Erhältlich in allen K2 Farben der folgenden Serie

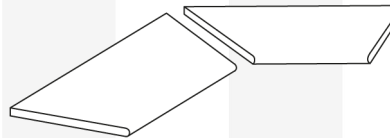

ANGOLARE INTERNO BORDO TORO 30x120 (12"x48") - 20 mm - Rettificato

▲ Grip R11

NOORD									
EDSX	NOORD WHITE	191,00	PZ	2	0,63			0,00	999
EDDX	NOORD WHITE	191,00							

Lavorato su richiesta. Disponibile in tutti i colori K2 delle seguenti serie / Manufactured upon request. Available in all K2 colors of the following collections / Seulement à la demande. Disponible dans toutes les couleurs K2 de la séries suivantes / Nur auf Anfrage. Erhältlich in allen K2 Farben der folgenden Serie

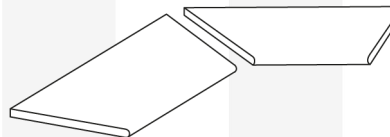

ANGOLARE INTERNO BORDO TORO 40x80 (16"x32") - 20 mm - Rettificato

▲ Grip R11

NOORD									
ED5I	NOORD WHITE	185,70	PZ	1	0,24			0,00	999
ED5L	NOORD WHITE	185,70							

Lavorato su richiesta. Disponibile in tutti i colori K2 delle seguenti serie / Manufactured upon request. Available in all K2 colors of the following collections / Seulement à la demande. Disponible dans toutes les couleurs K2 de la séries suivantes / Nur auf Anfrage. Erhältlich in allen K2 Farben der folgenden Serie

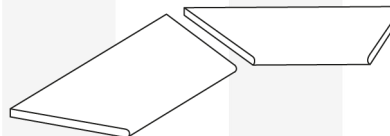

Size	Code	Colour	Euro	U.M.	Pcs / Box	Mq / Box	Kg / Box	Mq / Pallet	Kg / Pallet	Box / Pallet
------	------	--------	------	------	--------------	-------------	-------------	----------------	----------------	-----------------

20MM - PEZZI SPECIALI / TRIMS

ANGOLARE INTERNO BORDO TORO 30x60 (12"x24") - 20 mm - Rettificato

▲ Grip R11

NOORD

4LED	NOORD GREY	81,20	PZ	1	0,14		0,00	999
41ED	NOORD GREY	81,20						
45ED	NOORD WHITE	81,20						
54ED	NOORD WHITE	81,20						

Lavorato su richiesta. Disponibile in tutti i colori K2 delle seguenti serie / Manufactured upon request. Available in all K2 colors of the following collections / Seulement à la demande. Disponible dans toutes les couleurs K2 de la séries suivantes / Nur auf Anfrage. Erhältlich in allen K2 Farben der folgenden Serie

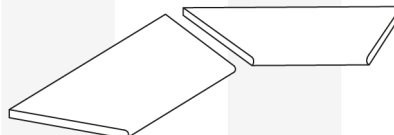

OUTDOOR Trims

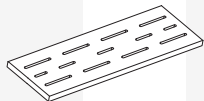
Size	Code	Colour	Euro	U.M.	Pcs / Box	Mq / Box	Kg / Box	Mq / Pallet	Kg / Pallet	Box / Pallet
20mm - PEZZI SPECIALI / TRIMS										
GRIGLIA 20x80 (8"x32") - 20 mm - Rettificato							Lavorato su richiesta. Disponibile in tutti i colori 20mm delle seguenti serie / Manufactured upon request. Available in all 20mm colors of the following collections / Seulement à la demande. Disponible dans toutes les couleurs 20mm de la séries suivantes / Nur auf Anfrage. Erhältlich in allen 20mm Farben der folgenden Serie			
▲ Grip R11										
		NOORD	212,30	PZ	2	0,32	14,85	Venduti solo a scatole complete / Only full boxes sold / Vendus par boite complete / Nur volle Karton		
▲ Structured R11										
		BRYSTONE	212,30							
		DISTRICT	212,30							
GRIGLIA 15x60 (6"x24") - 20 mm - Rettificato							Lavorato su richiesta. Disponibile in tutti i colori 20mm delle seguenti serie / Manufactured upon request. Available in all 20mm colors of the following collections / Seulement à la demande. Disponible dans toutes les couleurs 20mm de la séries suivantes / Nur auf Anfrage. Erhältlich in allen 20mm Farben der folgenden Serie			
▲ Grip R11										
		CHORUS	138,30	PZ	2	0,18	8,40	Venduti solo a scatole complete / Only full boxes sold / Vendus par boite complete / Nur volle Karton		
		MOOV	138,30							
		NOORD	138,30							
▲ Structured R11										
		ARKÈ	138,30							
		DOLMIX	138,30							
		EXTREME - Contract	138,30							
		GEO	138,30							
		HERITAGE	138,30							
		LAVICA	138,30							
		LIMES	174,20							
		MIDLAKE	174,20							
		OMNIA	174,20							
		PERCORSI EXTRA	138,30							
		PERCORSI FRAME	138,30							
		PERCORSI SMART	138,30							
		SWISSTONE - Contract	138,30							
		UBIK	138,30							
		VERSILIA	138,30							

Size	Code	Colour	Euro	U.M.	Pcs / Box	Mq / Box	Kg / Box	Mq / Pallet	Kg / Pallet	Box / Pallet
------	------	--------	------	------	-----------	----------	----------	-------------	-------------	--------------

20mm - PEZZI SPECIALI / TRIMS

ANGOLARE GRIGLIA 20x80 (8"x32") - 20 mm - Rettificato

Lavorato su richiesta. Disponibile in tutti i colori 20mm delle seguenti serie / Manufactured upon request. Available in all 20mm colors of the following collections / Seulement à la demande. Disponible dans toutes les couleurs 20mm de la séries suivantes / Nur auf Anfrage. Erhältlich in allen 20mm Farben der folgenden Serie

▲ Grip R11

NOORD COMP. DX + SX ** 445,00 KIT 1 0,28 13,00

Venduti solo a scatole complete / Only full boxes sold / Vendus par boite complete / Nur volle Karton

▲ Structured R11

BRYSTONE COMP. DX + SX ** 445,00
DISTRICT COMP. DX + SX **

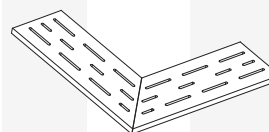

ANGOLARE GRIGLIA 15x60 (6"x24") - 20 mm - Rettificato

Lavorato su richiesta. Disponibile in tutti i colori 20mm delle seguenti serie / Manufactured upon request. Available in all 20mm colors of the following collections / Seulement à la demande. Disponible dans toutes les couleurs 20mm de la séries suivantes / Nur auf Anfrage. Erhältlich in allen 20mm Farben der folgenden Serie

▲ Grip R11

CHORUS COMP. DX + SX ** 294,90 KIT 1 0,16 7,35
MOOV COMP. DX + SX ** 294,90
NOORD COMP. DX + SX ** 294,90

▲ Structured R11

ARKÈ COMP. DX + SX ** 294,90
DOLMIX COMP. DX + SX ** 294,90
EXTREME - Contract COMP. DX + SX ** 294,90
GEO COMP. DX + SX ** 294,90
HERITAGE COMP. DX + SX ** 294,90
LAVICA COMP. DX + SX ** 294,90
OMNIA COMP. DX + SX ** 361,00
PERCORSI EXTRA COMP. DX + SX ** 294,90
PERCORSI FRAME COMP. DX + SX ** 294,90
PERCORSI SMART COMP. DX + SX ** 294,90
SWISSTONE - Contract COMP. DX + SX ** 294,90
UBIK COMP. DX + SX ** 294,90
VERSILIA COMP. DX + SX ** 294,90

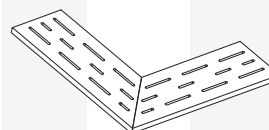

** Prezzo complessivo kit DX+SX / Kit price including DX + SX / Prix du kit incluant DX + SX / Kit Preis inklusive DX + SX / Precio del kit que incluye DX + SX

Size	Code	Colour	Euro	U.M.	Pcs / Box	Mq / Box	Kg / Box	Mq / Pallet	Kg / Pallet	Box / Pallet
------	------	--------	------	------	-----------	----------	----------	-------------	-------------	--------------

20mm - PEZZI SPECIALI / TRIMS

GRADINO BORDO TORO 60x120 (24"x48") - 20 mm - Rettificato

Lavorato su richiesta. Disponibile in tutti i colori 20mm delle seguenti serie / Manufactured upon request. Available in all 20mm colors of the following collections / Seulement à la demande. Disponible dans toutes les couleurs 20mm de la séries suivantes / Nur auf Anfrage. Erhältlich in allen 20mm Farben der folgenden Serie

▲ Grip R11

CHORUS	177,10	PZ	1
NOORD	177,10		

▲ Structured R11

ARKÈ	177,10
DOLMIX	177,10
GEO	177,10
HERITAGE	177,10
LAVICA	177,10
OMNIA	177,10
PERCORSI EXTRA	177,10
PERCORSI FRAME	177,10
PERCORSI SMART	177,10
UBIK	177,10
VERSILIA	177,10

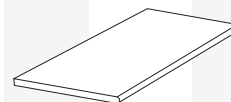

Size	Code	Colour	Euro	U.M.	Pcs / Box	Mq / Box	Kg / Box	Mq / Pallet	Kg / Pallet	Box / Pallet
------	------	--------	------	------	-----------	----------	----------	-------------	-------------	--------------

20mm - PEZZI SPECIALI / TRIMS

GRADINO BORDO TORO 30x120 (12"x48") - 20 mm - Rettificato

Lavorato su richiesta. Disponibile in tutti i colori 20mm delle seguenti serie / Manufactured upon request. Available in all 20mm colors of the following collections / Seulement à la demande. Disponible dans toutes les couleurs 20mm de la séries suivantes / Nur auf Anfrage. Erhältlich in allen 20mm Farben der folgenden Serie

▲ Grip R11

CHORUS	162,20	PZ	1
NOORD	170,00		

▲ Structured R11

ARKÈ	162,20		
DOLMIX	162,20		
EVOKE	162,20		
GEO	162,20		
HERITAGE	162,20		
JOURNEY	162,20		
LAVICA	162,20		
OMNIA	162,20		
PERCORSI EXTRA	162,20		
PERCORSI FRAME	162,20		
PERCORSI SMART	162,20		
SOUL	162,20		
UBIK	162,20		
VERSILIA	162,20		

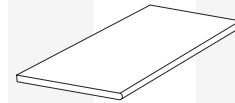

GRADINO BORDO TORO 45x90 (18"x36") - 20 mm - Rettificato

Lavorato su richiesta. Disponibile in tutti i colori 20mm delle seguenti serie / Manufactured upon request. Available in all 20mm colors of the following collections / Seulement à la demande. Disponible dans toutes les couleurs 20mm de la séries suivantes / Nur auf Anfrage. Erhältlich in allen 20mm Farben der folgenden Serie

▲ Grip R11

MOOV	116,30	PZ	1
------	--------	----	---

▲ Structured R11

BRYSTONE	116,30	PZ	1
EXTREME - Contract	116,30		
MIDLAKE	116,30		
PERCORSI EXTRA	116,30		
PERCORSI SMART	116,30		

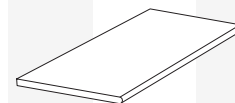

Size	Code	Colour	Euro	U.M.	Pcs / Box	Mq / Box	Kg / Box	Mq / Pallet	Kg / Pallet	Box / Pallet
GRADINO BORDO TORO 40x80 (16"x32") - 20 mm - Rettificato			Lavorato su richiesta. Disponibile in tutti i colori 20mm delle seguenti serie / Manufactured upon request. Available in all 20mm colors of the following collections / Seulement à la demande. Disponible dans toutes les couleurs 20mm de la séries suivantes / Nur auf Anfrage. Erhältlich in allen 20mm Farben der folgenden Serie							
▲ Grip R11										
	NOORD		138,30	PZ	1					
▲ Structured R11										
	BRYSTONE		138,30							
	DISTRICT		138,30							
GRADINO BORDO TORO 30x60 (12"x24") - 20 mm - Rettificato			Lavorato su richiesta. Disponibile in tutti i colori 20mm delle seguenti serie / Manufactured upon request. Available in all 20mm colors of the following collections / Seulement à la demande. Disponible dans toutes les couleurs 20mm de la séries suivantes / Nur auf Anfrage. Erhältlich in allen 20mm Farben der folgenden Serie							
▲ Grip R11										
	CHORUS		59,50	PZ	1					
	MOOV		59,50							
	NOORD		59,50							
▲ Structured R11										
	ARKÈ		59,50							
	DOLMIX		59,50							
	EXTREME - Contract		59,50							
	GEO		59,50							
	HERITAGE		59,50							
	LAVICA		59,50							
	OMNIA		59,50							
	PERCORSI EXTRA		59,50							
	PERCORSI FRAME		59,50							
	PERCORSI SMART		59,50							
	SWISSTONE - Contract		59,50							
	UBIK		59,50							
	VERSILIA		59,50							

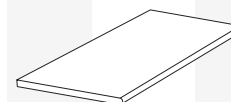
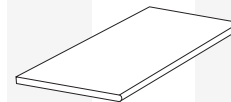

Size	Code	Colour	Euro	U.M.	Pcs / Box	Mq / Box	Kg / Box	Mq / Pallet	Kg / Pallet	Box / Pallet
------	------	--------	------	------	-----------	----------	----------	-------------	-------------	--------------

20mm - PEZZI SPECIALI / TRIMS

ANGOLARE BORDOTORO 40x40 (16"x16") - 20mm - Rettificato

Lavorato su richiesta. Disponibile in tutti i colori 20mm delle seguenti serie / Manufactured upon request. Available in all 20mm colors of the following collections / Seulement à la demande. Disponible dans toutes les couleurs 20mm de la séries suivantes / Nur auf Anfrage. Erhältlich in allen 20mm Farben der folgenden Serie

▲ Grip R11

NOORD	138,30	PZ	3
-------	--------	----	---

▲ Structured R11

BRYSTONE	138,30
DISTRICT	138,30



ANGOLARE BORDOTORO 30x30 (12"x12") - 20mm - Rettificato

Lavorato su richiesta. Disponibile in tutti i colori 20mm delle seguenti serie / Manufactured upon request. Available in all 20mm colors of the following collections / Seulement à la demande. Disponible dans toutes les couleurs 20mm de la séries suivantes / Nur auf Anfrage. Erhältlich in allen 20mm Farben der folgenden Serie

▲ Grip R11

CHORUS	55,70	PZ	1
MOOV	55,70		
NOORD	55,70		

▲ Structured R11

ARKÈ	55,70
DOLMIX	55,70
EXTREME - Contract	55,70
GEO	55,70
HERITAGE	55,70
LAVICA	55,70
OMNIA	55,70
PERCORSI EXTRA	55,70
PERCORSI FRAME	55,70
PERCORSI SMART	55,70
SWISSTONE - Contract	55,70
UBIK	55,70
VERSILIA	55,70



Size	Code	Colour	Euro	U.M.	Pcs / Box	Mq / Box	Kg / Box	Mq / Pallet	Kg / Pallet	Box / Pallet
------	------	--------	------	------	-----------	----------	----------	-------------	-------------	--------------

20mm - PEZZI SPECIALI / TRIMS

TOP BORDO TORO 40x80 (16"x32") - 20 mm - Rettificato

Lavorato su richiesta. Disponibile in tutti i colori 20mm delle seguenti serie / Manufactured upon request. Available in all 20mm colors of the following collections / Seulement à la demande. Disponible dans toutes les couleurs 20mm de la séries suivantes / Nur auf Anfrage. Erhältlich in allen 20mm Farben der folgenden Serie

▲ Grip R11

NOORD	193,50	PZ	1
-------	--------	----	---

▲ Structured R11

BRYSTONE	193,50
----------	--------

DISTRICT	193,50
----------	--------

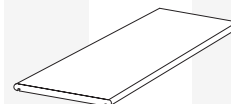

TOP BORDO TORO 30x60 (12"x24") - 20 mm - Rettificato

Lavorato su richiesta. Disponibile in tutti i colori 20mm delle seguenti serie / Manufactured upon request. Available in all 20mm colors of the following collections / Seulement à la demande. Disponible dans toutes les couleurs 20mm de la séries suivantes / Nur auf Anfrage. Erhältlich in allen 20mm Farben der folgenden Serie

▲ Grip R11

CHORUS	131,80	PZ	1
--------	--------	----	---

MOOV	131,80
------	--------

NOORD	131,80
-------	--------

▲ Structured R11

ARKÈ	131,80
------	--------

DOLMIX	131,80
--------	--------

EXTREME - Contract	131,80
--------------------	--------

GEO	131,80
-----	--------

HERITAGE	131,80
----------	--------

LAVICA	131,80
--------	--------

OMNIA	131,80
-------	--------

PERCORSI EXTRA	131,80
----------------	--------

PERCORSI FRAME	131,80
----------------	--------

PERCORSI SMART	131,80
----------------	--------

SWISSTONE - Contract	131,80
----------------------	--------

UBIK	131,80
------	--------

VERSILIA	131,80
----------	--------

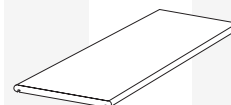

Size	Code	Colour	Euro	U.M.	Pcs / Box	Mq / Box	Kg / Box	Mq / Pallet	Kg / Pallet	Box / Pallet
------	------	--------	------	------	--------------	-------------	-------------	----------------	----------------	-----------------

20mm - PEZZI SPECIALI / TRIMS

ANG. EST. BORDO TORO 60x120 (24"x48") - 20mm - Rettificato

Lavorato su richiesta. Disponibile in tutti i colori 20mm delle seguenti serie / Manufactured upon request. Available in all 20mm colors of the following collections / Seulement à la demande. Disponible dans toutes les couleurs 20mm de la séries suivantes / Nur auf Anfrage. Erhältlich in allen 20mm Farben der folgenden Serie

▲ Grip R11

CHORUS COMP. DX + SX **	469,60	KIT	1
NOORD COMP. DX + SX **	469,60		

▲ Structured R11

ARKÈ COMP. DX + SX **	469,60
DOLMIX COMP. DX + SX **	469,60
GEO COMP. DX + SX **	469,60
HERITAGE COMP. DX + SX **	469,60
LAVICA COMP. DX + SX **	469,60
OMNIA COMP. DX + SX **	469,60
PERCORSI EXTRA COMP. DX + SX **	469,60
PERCORSI FRAME COMP. DX + SX **	469,60
PERCORSI SMART COMP. DX + SX **	469,60
UBIK COMP. DX + SX **	469,60
VERSILIA COMP. DX + SX **	469,60

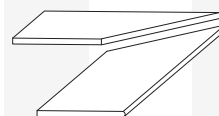

** Prezzo complessivo kit DX+SX / Kit price including DX + SX / Prix du kit incluant DX + SX / Kit Preis inklusive DX + SX / Precio del kit que incluye DX + SX

Size	Code	Colour	Euro	U.M.	Pcs / Box	Mq / Box	Kg / Box	Mq / Pallet	Kg / Pallet	Box / Pallet
------	------	--------	------	------	-----------	----------	----------	-------------	-------------	--------------

20mm - PEZZI SPECIALI / TRIMS

ANG. EST. BORDO TORO 30x120 (12"x48") - 20mm - Rettificato

Lavorato su richiesta. Disponibile in tutti i colori 20mm delle seguenti serie / Manufactured upon request. Available in all 20mm colors of the following collections / Seulement à la demande. Disponible dans toutes les couleurs 20mm de la séries suivantes / Nur auf Anfrage. Erhältlich in allen 20mm Farben der folgenden Serie

▲ Grip R11

CHORUS COMP. DX + SX **	381,90	KIT	1
NOORD COMP. DX + SX **	381,90		

▲ Structured R11

ARKÈ COMP. DX + SX **	381,90		
DOLMIX COMP. DX + SX **	381,90		
EVOKE COMP. DX + SX **	381,90		
GEO COMP. DX + SX **	381,90		
HERITAGE COMP. DX + SX **	381,90		
JOURNEY COMP. DX + SX **	381,90		
LAVICA COMP. DX + SX **	381,90		
OMNIA COMP. DX + SX **	381,90		
PERCORSI EXTRA COMP. DX + SX **	381,90		
PERCORSI FRAME COMP. DX + SX **	381,90		
PERCORSI SMART COMP. DX + SX **	381,90		
SOUL COMP. DX + SX **	381,90		
UBIK COMP. DX + SX **	381,90		
VERSILIA COMP. DX + SX **	381,90		

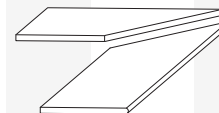

ANG. EST. BORDO TORO 45x90 (18"x36") - 20mm - Rettificato

Lavorato su richiesta. Disponibile in tutti i colori 20mm delle seguenti serie / Manufactured upon request. Available in all 20mm colors of the following collections / Seulement à la demande. Disponible dans toutes les couleurs 20mm de la séries suivantes / Nur auf Anfrage. Erhältlich in allen 20mm Farben der folgenden Serie

▲ Grip R11

MOOV COMP. DX + SX **	319,20	KIT	1
-----------------------	--------	-----	---

▲ Structured R11

BRYSTONE COMP. DX + SX **	319,20	KIT	1
EXTREME - Contract COMP. DX + SX **	319,20		
MIDLAKE COMP. DX + SX **	319,20		
PERCORSI EXTRA COMP. DX + SX **	319,20		
PERCORSI SMART COMP. DX + SX **	319,20		

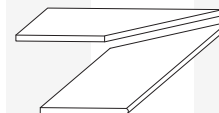

** Prezzo complessivo kit DX+SX / Kit price including DX + SX / Prix du kit incluant DX + SX / Kit Preis inklusive DX + SX / Precio del kit que incluye DX + SX

Size	Code	Colour	Euro	U.M.	Pcs / Box	Mq / Box	Kg / Box	Mq / Pallet	Kg / Pallet	Box / Pallet
------	------	--------	------	------	-----------	----------	----------	-------------	-------------	--------------

20mm - PEZZI SPECIALI / TRIMS

ANG. EST. BORDO TORO 40x80 (16"x32") - 20mm - Rettificato

Lavorato su richiesta. Disponibile in tutti i colori 20mm delle seguenti serie / Manufactured upon request. Available in all 20mm colors of the following collections / Seulement à la demande. Disponible dans toutes les couleurs 20mm de la séries suivantes / Nur auf Anfrage. Erhältlich in allen 20mm Farben der folgenden Serie

▲ Grip R11

NOORD COMP. DX + SX **	371,40	KIT	1
------------------------	--------	-----	---

▲ Structured R11

BRYSTONE COMP. DX + SX **	371,40
---------------------------	--------

DISTRICT COMP. DX + SX **	371,40
---------------------------	--------

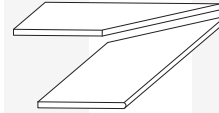

ANG. EST. BORDO TORO 30x60 (12"x24") - 20mm - Rettificato

Lavorato su richiesta. Disponibile in tutti i colori 20mm delle seguenti serie / Manufactured upon request. Available in all 20mm colors of the following collections / Seulement à la demande. Disponible dans toutes les couleurs 20mm de la séries suivantes / Nur auf Anfrage. Erhältlich in allen 20mm Farben der folgenden Serie

▲ Grip R11

CHORUS COMP. DX + SX **	162,40	KIT	1
-------------------------	--------	-----	---

MOOV COMP. DX + SX **	162,40
-----------------------	--------

NOORD COMP. DX + SX **	162,40
------------------------	--------

▲ Structured R11

ARKÈ COMP. DX + SX **	162,40
-----------------------	--------

BRYSTONE COMP. DX + SX **	162,40
---------------------------	--------

DOLMIX COMP. DX + SX **	162,40
-------------------------	--------

EXTREME - Contract COMP. DX + SX **	162,40
-------------------------------------	--------

GEO COMP. DX + SX **	162,40
----------------------	--------

HERITAGE COMP. DX + SX **	162,40
---------------------------	--------

LAVICA COMP. DX + SX **	162,40
-------------------------	--------

OMNIA COMP. DX + SX **	162,40
------------------------	--------

PERCORSI EXTRA COMP. DX + SX **	162,40
---------------------------------	--------

PERCORSI FRAME COMP. DX + SX **	162,40
---------------------------------	--------

PERCORSI SMART COMP. DX + SX **	162,40
---------------------------------	--------

SWISSTONE - Contract COMP. DX + SX **	162,40
---------------------------------------	--------

UBIK COMP. DX + SX **	162,40
-----------------------	--------

VERSILIA COMP. DX + SX **	162,40
---------------------------	--------

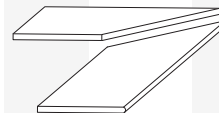

Size	Code	Colour	Euro	U.M.	Pcs / Box	Mq / Box	Kg / Box	Mq / Pallet	Kg / Pallet	Box / Pallet
------	------	--------	------	------	-----------	----------	----------	-------------	-------------	--------------

20mm - PEZZI SPECIALI / TRIMS

ANG. INT. BORDO TORO 60x120 (24"x48") - 20mm - Rettificato

Lavorato su richiesta. Disponibile in tutti i colori 20mm delle seguenti serie / Manufactured upon request. Available in all 20mm colors of the following collections / Seulement à la demande. Disponible dans toutes les couleurs 20mm de la séries suivantes / Nur auf Anfrage. Erhältlich in allen 20mm Farben der folgenden Serie

▲ Grip R11

CHORUS COMP. DX + SX **	469,60	KIT	1
NOORD COMP. DX + SX **	469,60		

▲ Structured R11

ARKÈ COMP. DX + SX **	469,60
DOLMIX COMP. DX + SX **	469,60
GEO COMP. DX + SX **	469,60
HERITAGE COMP. DX + SX **	469,60
LAVICA COMP. DX + SX **	469,60
OMNIA COMP. DX + SX **	469,60
PERCORSI EXTRA COMP. DX + SX **	469,60
PERCORSI FRAME COMP. DX + SX **	469,60
PERCORSI SMART COMP. DX + SX **	469,60
UBIK COMP. DX + SX **	469,60
VERSILIA COMP. DX + SX **	469,60

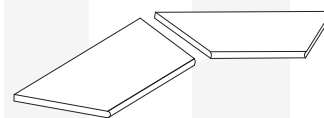

** Prezzo complessivo kit DX+SX / Kit price including DX + SX / Prix du kit incluant DX + SX / Kit Preis inklusive DX + SX / Precio del kit que incluye DX + SX

Size	Code	Colour	Euro	U.M.	Pcs / Box	Mq / Box	Kg / Box	Mq / Pallet	Kg / Pallet	Box / Pallet
------	------	--------	------	------	-----------	----------	----------	-------------	-------------	--------------

20mm - PEZZI SPECIALI / TRIMS

ANG. INT. BORDO TORO 30x120 (12"x48") - 20mm - Rettificato

Lavorato su richiesta. Disponibile in tutti i colori 20mm delle seguenti serie / Manufactured upon request. Available in all 20mm colors of the following collections / Seulement à la demande. Disponible dans toutes les couleurs 20mm de la séries suivantes / Nur auf Anfrage. Erhältlich in allen 20mm Farben der folgenden Serie

▲ Grip R11

CHORUS COMP. DX + SX **	381,90	KIT	1
NOORD COMP. DX + SX **	381,90		

▲ Structured R11

ARKÈ COMP. DX + SX **	381,90		
DOLMIX COMP. DX + SX **	381,90		
EVOKE COMP. DX + SX **	381,90		
GEO COMP. DX + SX **	381,90		
HERITAGE COMP. DX + SX **	381,90		
JOURNEY COMP. DX + SX **	381,90		
LAVICA COMP. DX + SX **	381,90		
OMNIA COMP. DX + SX **	381,90		
PERCORSI EXTRA COMP. DX + SX **	381,90		
PERCORSI FRAME COMP. DX + SX **	381,90		
PERCORSI SMART COMP. DX + SX **	381,90		
SOUL COMP. DX + SX **	381,90		
UBIK COMP. DX + SX **	381,90		
VERSILIA COMP. DX + SX **	381,90		

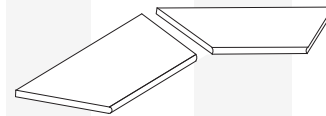

ANG. INT. BORDO TORO 45x90 (18"x36") - 20mm - Rettificato

Lavorato su richiesta. Disponibile in tutti i colori 20mm delle seguenti serie / Manufactured upon request. Available in all 20mm colors of the following collections / Seulement à la demande. Disponible dans toutes les couleurs 20mm de la séries suivantes / Nur auf Anfrage. Erhältlich in allen 20mm Farben der folgenden Serie

▲ Grip R11

MOOV COMP. DX + SX **	319,20	KIT	1
-----------------------	--------	-----	---

▲ Structured R11

BRYSTONE COMP. DX + SX **	319,20	KIT	1
EXTREME - Contract COMP. DX + SX **	319,20		
MIDLAKE COMP. DX + SX **	319,20		
PERCORSI EXTRA COMP. DX + SX **	319,20		
PERCORSI SMART COMP. DX + SX **	319,20		

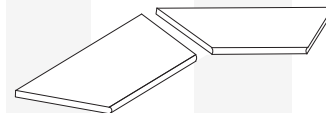

Size	Code	Colour	Euro	U.M.	Pcs / Box	Mq / Box	Kg / Box	Mq / Pallet	Kg / Pallet	Box / Pallet
------	------	--------	------	------	-----------	----------	----------	-------------	-------------	--------------

20mm - PEZZI SPECIALI / TRIMS

ANG. INT. BORDO TORO 40x80 (16"x32") - 20mm - Rettificato

Lavorato su richiesta. Disponibile in tutti i colori 20mm delle seguenti serie / Manufactured upon request. Available in all 20mm colors of the following collections / Seulement à la demande. Disponible dans toutes les couleurs 20mm de la séries suivantes / Nur auf Anfrage. Erhältlich in allen 20mm Farben der folgenden Serie

▲ Grip R11

NOORD COMP. DX + SX **	371,40	KIT	1
------------------------	--------	-----	---

▲ Structured R11

BRYSTONE COMP. DX + SX **	371,40
---------------------------	--------

DISTRICT COMP. DX + SX **	371,40
---------------------------	--------

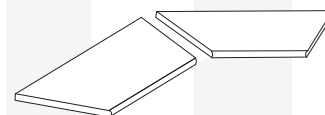

ANG. INT. BORDO TORO 30x60 (12"x24") - 20mm - Rettificato

Lavorato su richiesta. Disponibile in tutti i colori 20mm delle seguenti serie / Manufactured upon request. Available in all 20mm colors of the following collections / Seulement à la demande. Disponible dans toutes les couleurs 20mm de la séries suivantes / Nur auf Anfrage. Erhältlich in allen 20mm Farben der folgenden Serie

▲ Grip R11

CHORUS COMP. DX + SX **	162,40	KIT	1
-------------------------	--------	-----	---

MOOV COMP. DX + SX **	162,40
-----------------------	--------

NOORD COMP. DX + SX **	162,40
------------------------	--------

▲ Structured R11

ARKÈ COMP. DX + SX **	162,40
-----------------------	--------

DOLMIX COMP. DX + SX **	162,40
-------------------------	--------

EXTREME - Contract COMP. DX + SX **	162,40
-------------------------------------	--------

GEO COMP. DX + SX **	162,40
----------------------	--------

HERITAGE COMP. DX + SX **	162,40
---------------------------	--------

LAVICA COMP. DX + SX **	162,40
-------------------------	--------

OMNIA COMP. DX + SX **	162,40
------------------------	--------

PERCORSI EXTRA COMP. DX + SX **	162,40
---------------------------------	--------

PERCORSI FRAME COMP. DX + SX **	162,40
---------------------------------	--------

PERCORSI SMART COMP. DX + SX **	162,40
---------------------------------	--------

SWISSTONE - Contract COMP. DX + SX **	162,40
---------------------------------------	--------

UBIK COMP. DX + SX **	162,40
-----------------------	--------

VERSILIA COMP. DX + SX **	162,40
---------------------------	--------

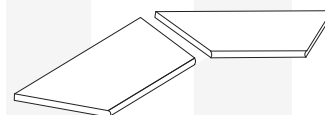

Size	Code	Colour	Euro	U.M.	Pcs / Box	Mq / Box	Kg / Box	Mq / Pallet	Kg / Pallet	Box / Pallet
------	------	--------	------	------	--------------	-------------	-------------	----------------	----------------	-----------------

20mm - PEZZI SPECIALI / TRIMS

SCALINO INC. 30x120x4 (12"x48") - 20mm - Rettificato

Lavorato su richiesta. Disponibile in tutti i colori 20mm delle seguenti serie / Manufactured upon request. Available in all 20mm colors of the following collections / Seulement à la demande. Disponible dans toutes les couleurs 20mm de la séries suivantes / Nur auf Anfrage. Erhältlich in allen 20mm Farben der folgenden Serie

▲ Structured R11

EVOKE	222,30
JOURNEY	222,30
SOUL	222,30

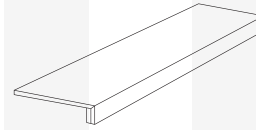

SCALINO ANG. INC. 30x120x4 (12"x48") - 20mm - Rettificato

Lavorato su richiesta. Disponibile in tutti i colori 20mm delle seguenti serie / Manufactured upon request. Available in all 20mm colors of the following collections / Seulement à la demande. Disponible dans toutes les couleurs 20mm de la séries suivantes / Nur auf Anfrage. Erhältlich in allen 20mm Farben der folgenden Serie

▲ Structured R11

EVOKE DX	244,40
EVOKE SX	244,40
JOURNEY DX	244,40
JOURNEY SX	244,40
SOUL DX	244,40
SOUL SX	244,40

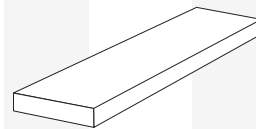

Size	Code	Colour	Euro	U.M.	Pcs / Box	Mq / Box	Kg / Box	Mq / Pallet	Kg / Pallet	Box / Pallet
------	------	--------	------	------	-----------	----------	----------	-------------	-------------	--------------

20mm - PEZZI SPECIALI / TRIMS

TERMINALE L 120x45x15 (48"x18"x6") (inc.) - 20mm - Rettificato

Lavorato su richiesta. Disponibile in tutti i colori 20mm delle seguenti serie / Manufactured upon request. Available in all 20mm colors of the following collections / Seulement à la demande. Disponible dans toutes les couleurs 20mm de la séries suivantes / Nur auf Anfrage. Erhältlich in allen 20mm Farben der folgenden Serie

▲ Grip R11

CHORUS	280,60	PZ	1	0,54	33,40
NOORD	280,60				

▲ Structured R11

ARKÈ	280,60
DOLMIX	280,60
GEO	280,60
HERITAGE	280,60
LAVICA	280,60
OMNIA	280,60
PERCORSI EXTRA	280,60
PERCORSI FRAME	280,60
PERCORSI SMART	280,60
UBIK	280,60
VERSILIA	280,60

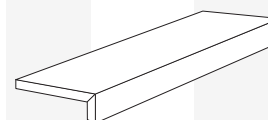

TERMINALE L 90x45x15 (36"x18"x6") (inc.) - 20mm - Rettificato

Lavorato su richiesta. Disponibile in tutti i colori 20mm delle seguenti serie / Manufactured upon request. Available in all 20mm colors of the following collections / Seulement à la demande. Disponible dans toutes les couleurs 20mm de la séries suivantes / Nur auf Anfrage. Erhältlich in allen 20mm Farben der folgenden Serie

▲ Grip R11

MOOV	162,40	PZ	3	0,91	42,32
------	--------	----	---	------	-------

▲ Structured R11

BRYSTONE	162,40
EXTREME - Contract	217,80
MIDLAKE	217,80
PERCORSI EXTRA	217,80
PERCORSI SMART	217,80

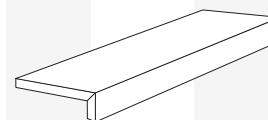

TERMINALE L 80x33x5 (32"x13"x2") (inc.) - 20mm - Rettificato

Lavorato su richiesta. Disponibile in tutti i colori 20mm delle seguenti serie / Manufactured upon request. Available in all 20mm colors of the following collections / Seulement à la demande. Disponible dans toutes les couleurs 20mm de la séries suivantes / Nur auf Anfrage. Erhältlich in allen 20mm Farben der folgenden Serie

▲ Grip R11

NOORD	162,40	PZ	3	0,91	42,32
-------	--------	----	---	------	-------

▲ Structured R11

BRYSTONE	162,40
DISTRICT	162,40

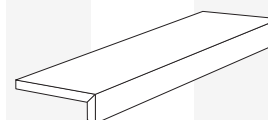

Size	Code	Colour	Euro	U.M.	Pcs / Box	Mq / Box	Kg / Box	Mq / Pallet	Kg / Pallet	Box / Pallet
20mm - PEZZI SPECIALI / TRIMS										
TERMINALE L 80x20x5 (32"x8"x2") (inc.) - 20 mm - Rettificato							Lavorato su richiesta. Disponibile in tutti i colori 20mm delle seguenti serie / Manufactured upon request. Available in all 20mm colors of the following collections / Seulement à la demande. Disponible dans toutes les couleurs 20mm de la séries suivantes / Nur auf Anfrage. Erhältlich in allen 20mm Farben der folgenden Serie			
▲ Grip R11										
	NOORD		144,90	PZ	2	0,40	9,28			
▲ Structured R11										
	BRYSTONE		144,90							
	DISTRICT		144,90							
TERMINALE L 60x33x5 (24"x13"x2") (inc.) - 20 mm - Rettificato							Lavorato su richiesta. Disponibile in tutti i colori 20mm delle seguenti serie / Manufactured upon request. Available in all 20mm colors of the following collections / Seulement à la demande. Disponible dans toutes les couleurs 20mm de la séries suivantes / Nur auf Anfrage. Erhältlich in allen 20mm Farben der folgenden Serie			
▲ Grip R11										
	CHORUS		120,40	PZ	1	0,20	8,30			
	MOOV		120,40							
	NOORD		120,40							
▲ Structured R11										
	ARKÈ		120,40							
	DOLMIX		120,40							
	EXTREME - Contract		120,40							
	GEO		120,40							
	HERITAGE		120,40							
	LAVICA		120,40							
	OMNIA		120,40							
	PERCORSI EXTRA		120,40							
	PERCORSI FRAME		120,40							
	PERCORSI SMART		120,40							
	SWISSTONE - Contract		120,40							
	UBIK		120,40							
	VERSILIA		120,40							

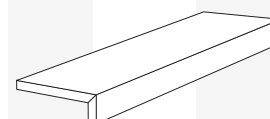
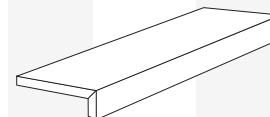

Size	Code	Colour	Euro	U.M.	Pcs / Box	Mq / Box	Kg / Box	Mq / Pallet	Kg / Pallet	Box / Pallet
------	------	--------	------	------	-----------	----------	----------	-------------	-------------	--------------

20mm - PEZZI SPECIALI / TRIMS

TERMINALE L 60x20x5 (24"x8"x2") (inc.) - 20 mm - Rettificato

Lavorato su richiesta. Disponibile in tutti i colori 20mm delle seguenti serie / Manufactured upon request. Available in all 20mm colors of the following collections / Seulement à la demande. Disponible dans toutes les couleurs 20mm de la séries suivantes / Nur auf Anfrage. Erhältlich in allen 20mm Farben der folgenden Serie

▲ Grip R11

CHORUS	120,40	PZ	1	0,20	8,30
MOOV	120,40				
NOORD	120,40				

▲ Structured R11

ARKÈ	120,40				
DOLMIX	120,40				
EXTREME - Contract	120,40				
GEO	120,40				
HERITAGE	120,40				
LAVICA	120,40				
OMNIA	120,40				
PERCORSI EXTRA	120,40				
PERCORSI FRAME	120,40				
PERCORSI SMART	120,40				
SWISSTONE - Contract	120,40				
UBIK	120,40				
VERSILIA	120,40				

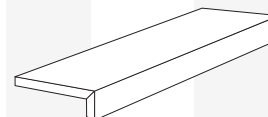

CORDOLO L 80x20x20 (32"x8"x8") (inc.) - 20 mm - Rettificato

Lavorato su richiesta. Disponibile in tutti i colori 20mm delle seguenti serie / Manufactured upon request. Available in all 20mm colors of the following collections / Seulement à la demande. Disponible dans toutes les couleurs 20mm de la séries suivantes / Nur auf Anfrage. Erhältlich in allen 20mm Farben der folgenden Serie

▲ Grip R11

NOORD	144,10	PZ	1	0,32	14,85
-------	--------	----	---	------	-------

▲ Structured R11

BRYSTONE	144,10				
DISTRICT	144,10				

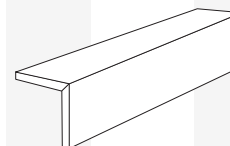

Size	Code	Colour	Euro	U.M.	Pcs / Box	Mq / Box	Kg / Box	Mq / Pallet	Kg / Pallet	Box / Pallet
------	------	--------	------	------	-----------	----------	----------	-------------	-------------	--------------

20mm - PEZZI SPECIALI / TRIMS

CORDOLO L 60x20x15 (24"x8"x6") (inc.) - 20 mm - Rettificato

Lavorato su richiesta. Disponibile in tutti i colori 20mm delle seguenti serie / Manufactured upon request. Available in all 20mm colors of the following collections / Seulement à la demande. Disponible dans toutes les couleurs 20mm de la séries suivantes / Nur auf Anfrage. Erhältlich in allen 20mm Farben der folgenden Serie

▲ Grip R11

CHORUS	126,40	PZ	1	0,12	9,80
MOOV	126,40				
NOORD	126,40				

▲ Structured R11

ARKÈ	126,40				
DOLMIX	126,40				
EXTREME - Contract	126,40				
GEO	126,40				
HERITAGE	126,40				
LAVICA	126,40				
OMNIA	126,40				
PERCORSI EXTRA	126,40				
PERCORSI FRAME	126,40				
PERCORSI SMART	126,40				
SWISSTONE - Contract	126,40				
UBIK	126,40				
VERSILIA	126,40				

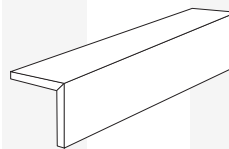

GRADONE (inc.) - 20 mm - Rettificato

Lavorato su richiesta. Disponibile in tutti i colori 20mm delle seguenti serie / Manufactured upon request. Available in all 20mm colors of the following collections / Seulement à la demande. Disponible dans toutes les couleurs 20mm de la séries suivantes / Nur auf Anfrage. Erhältlich in allen 20mm Farben der folgenden Serie

▲ Structured R11

120x35x15 (48"x14"x6") da 60x120 20mm	707,90	PZ	1		
90x35x15 (36"x14"x6") da 45x90 20mm	584,50				
60x35x15 (24"x14"x6") da 60x60 20mm	412,90				

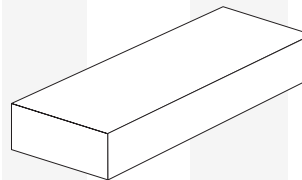

Accessories

Size	Code	Colour	Euro	U.M.	Pcs / Box	Mq / Box	Kg / Box	Mq / Pallet	Kg / Pallet	Box / Pallet
20mm / 30mm										
ACCESSORIES 										
SUPPORTO FISSO										
K2f1	LH3 DISCO LIVELLATORE SUPPL. 3MM		0,90	PZ	1		0,04			
K2F1	EH12/8 SUPPORTO 12MM / FUGA 2,5MM		0,80							
K2F2	EH12 SUPPORTO 12MM / FUGA 3MM		0,80							
K2F3	EH15 SUPPORTO 15MM / FUGA 3MM		0,80							
K2F4	EH20 SUPPORTO 20MM / FUGA 4MM		1,40							
SUPPORTO REGOLABILE										
K2r2	LGH2 DISCO LIVELLATORE SUPPL. 2MM		1,40	PZ	1		0,04			
K2r3	LGH3 DISCO LIVELLATORE SUPPL. 3MM		1,40							
K2R1	NM1 SUPPORTO REGOLABILE 25/40MM		9,00							
K2R2	NM2 SUPPORTO REGOLABILE 40/70MM		10,10							
K2R3	NM3 SUPPORTO REGOLABILE 60/100MM		11,50							
K2R4	NM4 SUPPORTO REGOLABILE 90/160MM		13,70							
K2R5	NM5 SUPPORTO REGOLABILE 150/270MM		16,00							
SUPPORTO AUTOLIVELLANTE										
K2r2	LGH2 DISCO LIVELLATORE SUPPL. 2MM		1,40	PZ	1		0,04			
K2r3	LGH3 DISCO LIVELLATORE SUPPL. 3MM		1,40							
K2A1	SE1 SUPPORTO AUTOLIV. 37,5/50MM		16,60							
K2A2	SE2 SUPPORTO AUTOLIV. 50/75MM		17,30							
K2A3	SE3 SUPPORTO AUTOLIV. 75/120MM		19,00							
K2A4	SE4 SUPPORTO AUTOLIV. 120/170MM		20,20							
K2A5	SE5 SUPPORTO AUTOLIV. 170/215MM		20,80							
K2A6	SE6 SUPPORTO AUTOLIV. 140/230MM		27,40							
K2A7	SE7 SUPPORTO AUTOLIV. 185/275MM		28,70							
CHIAVE DI REGOLAZIONE PER SUPPORTO REGOLABILE E AUTOLIVELLANTE										
K2T1	CHIAVE DI REGOLAZIONE		147,00	PZ	1		0,04			
DISTANZIATORE PERIMETRALE										
K2C3	CLIP BORDO PAVIMENTO DISTANZA 20MM		16,80	PZ	1		0,04			

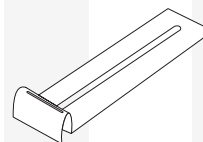
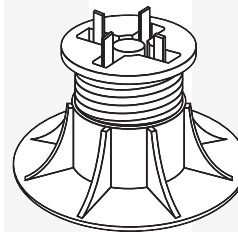
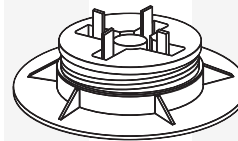
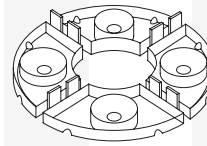

Size	Code	Colour	Euro	U.M.	Pcs / Box	Mq / Box	Kg / Box	Mq / Pallet	Kg / Pallet	Box / Pallet
------	------	--------	------	------	-----------	----------	----------	-------------	-------------	--------------

20mm / 30mm

ACCESSORIES

CLIP FISSAGGIO VERTICALE

K2C1	CLIP FISSAGGIO VERTICALE TESTA	24,70	PZ	1	0,04					
K2C2	CLIP FISSAGGIO VERTICALE BASE	26,30								

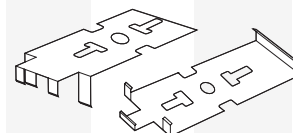

CROCETTA GHOST

WAN8	CROCETTA GHOST 4MM	0,90	PZ	100	2,00	265,00	126			
------	--------------------	------	----	-----	------	--------	-----	--	--	--

Venduti solo a scatole complete / Only full boxes sold /
Vendus par boite complete / Nur volle Karton

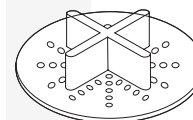

GRID SYSTEM

BASE

WDE1	MODULO BASE	24,70	PZ	15	5,40	40,20	10,80	93,40	2	
------	-------------	-------	----	----	------	-------	-------	-------	---	--

Venduti solo a scatole complete / Only full boxes sold /
Vendus par boite complete / Nur volle Karton

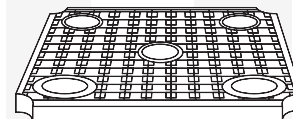

SUPPORTO REGOLABILE

WDY2	KIT SUPPORTO	165,00	KIT	1	5,40	9,70	48,60	100,30	9	
------	--------------	--------	-----	---	------	------	-------	--------	---	--

SEPARATORE DI POSA 33PZ

SUPPORTO DI FISSAGGIO 38PZ

REGOLAZIONE SUPPORTO 38PZ

BASE SUPPORTO 38PZ

Venduti solo a scatole complete / Only full boxes sold /
Vendus par boite complete / Nur volle Karton

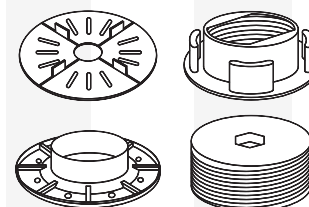

TRAVERSI DI RINFORZO

WFJ1	TRAVERSI	77,90	BOX	30	5,40	10,00	54,00	113,00	10	
------	----------	-------	-----	----	------	-------	-------	--------	----	--

Venduti solo a scatole complete / Only full boxes sold /
Vendus par boite complete / Nur volle Karton

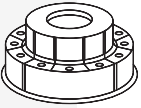
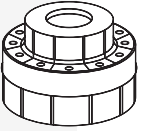
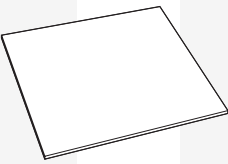

Size	Code	Colour	Euro	U.M.	Pcs / Box	Mq / Box	Kg / Box	Mq / Pallet	Kg / Pallet	Box / Pallet
20mm / 30mm										
GRID SYSTEM 										
DISTANZIALE 25MM										
WDE3	DISTANZIALE FISSO 25MM		0,90	PZ	38	5,40	3,20	162,00	109,00	30
										
DISTANZIALE 50MM										
WDE4	DISTANZIALE FISSO 50MM		1,20	PZ	38	5,40	5,60	64,80	80,20	12
							Venduti solo a scatole complete / Only full boxes sold / Vendus par boite complete / Nur volle Karton			
										
TAPPETO FONASSORBENTE										
WDF7	TAPPETO FONASSORBENTE 200x200MM		1,20	PZ	80	11,40	0,10	273,60	15,40	24
							Venduti solo a scatole complete / Only full boxes sold / Vendus par boite complete / Nur volle Karton			
										

Size	Code	Colour	Euro	U.M.	Pcs / Box	Mq / Box	Kg / Box	Mq / Pallet	Kg / Pallet	Box / Pallet
------	------	--------	------	------	-----------	----------	----------	-------------	-------------	--------------

20mm

DECKING SYSTEM

SUPPORTO BASIC REGOLABILE 27/300MM

K2B1	SB1 DK-SUPP. REGOLABILE 27/35MM	7,10	PZ	1		0,16				
K2B2	SB2 DK-SUPP. REGOLABILE 35/50MM	7,80				0,18				
K2B3	SB3 DK-SUPP. REGOLABILE 50/80MM*	8,40				0,20				
K2B4	SB4 DK-SUPP. REGOLABILE 70/120MM*	9,10				0,25				
K2P2	PSB PROLUNGA SUPP. REGOLABILE*	3,80				0,10				

*ProL. K2P2 utilizzabile solo con K2B3 o K2B4 / K2P2 ext. fitting only with K2B3 or K2B4 / Raccord d'ext. K2P2 uniquement avec K2B3 ou K2B4 / K2P2-Verlängerungsarmatur nur mit K2B3 oder K2B4 / Accesorio de ext. K2P2 solo con K2B3 o K2B4

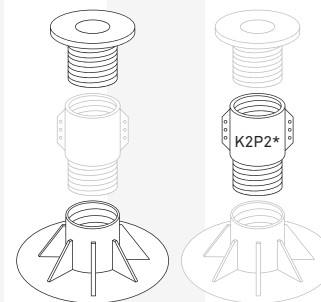

SUPPORTO AUTOLIVELLANTE 28/550MM

K2E0	SE0 DK-SUPP. AUTOLIVELLANTE 28/38MM	15,00	PZ	1		0,25				
K2U1	SE1 DK-SUPP. AUTOLIVELLANTE 37,5/50MM	16,60				0,30				
K2U2	SE2 DK-SUPP. AUTOLIVELLANTE 50/75MM	17,30				0,35				
K2U3	SE3 DK-SUPP. AUTOLIVELLANTE 75/120MM**	19,00				0,48				
K2U4	SE4 DK-SUPP. AUTOLIVELLANTE 120/170MM**	20,20				0,54				
K2U5	SE5 DK-SUPP. AUTOLIVELLANTE 170/215MM**	20,80				0,61				
K2P1	P1 PROLUNGA SUPP. AUTOLIVELLANTE**	6,50				0,23				

**ProL. K2P1 utilizzabile solo con K2U3 o K2U4 o K2U5 / K2P1 ext. fitting only with K2U3 or K2U4 or K2U5 / Raccord d'ext. K2P1 uniquement avec K2U3 ou K2U4 ou K2U5 / K2P1-Verlängerungsarmatur nur mit K2U3 oder K2U4 oder K2U5 / Accesorio de ext. K2P1 solo con K2U3 o K2U4 o K2U5

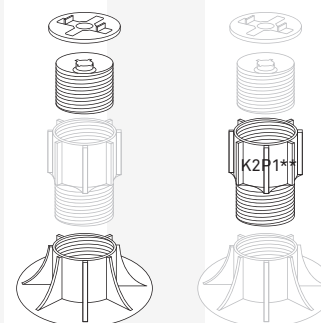

TRAVETTO IN ALLUMINIO 65x25x2000MM

K2D1	DK-TRAVETTO IN ALLUMINIO	55,80	PZ	1	Mt	2,00	0,90			
------	--------------------------	-------	----	---	----	------	------	--	--	--

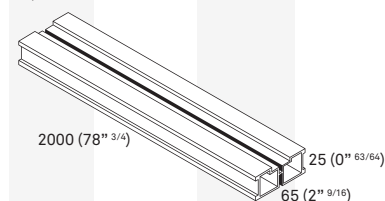

DISCO COMPENSATORE DI PENDENZA PER BASE SUPPORTO Ø150MM

K2D8	DK-COMP.PENDENZA TW 150	1,20	PZ	1		0,05				
------	-------------------------	------	----	---	--	------	--	--	--	--



Size	Code	Colour	Euro	U.M.	Pcs / Box	Mq / Box	Kg / Box	Mq / Pallet	Kg / Pallet	Box / Pallet
------	------	--------	------	------	--------------	-------------	-------------	----------------	----------------	-----------------

20mm

DECKING SYSTEM

RACCORDO PER TRAVETTO

K2D7	DK-RACCORDO TRAVETTO	1,10	PZ	1		0,02				
------	----------------------	------	----	---	--	------	--	--	--	--

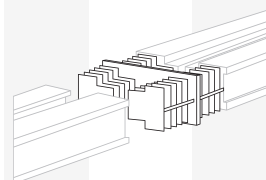

BOBINA GOMMA ANTIRUMORE PER TRAVETTI 15x2x10000MM

K2D6	DK-GOMMA ANTIRUMORE	29,80	PZ	1	Mt 10	0,09				
------	---------------------	-------	----	---	----------	------	--	--	--	--

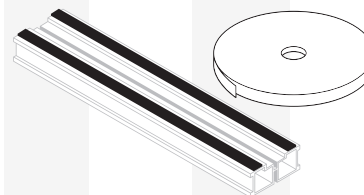

CLIP LATERALE PIASTRELLA 90° PER TRAVETTO IN ALLUMINIO

K2D2	DK-CLIP LATERALE 90°	72,70	BOX	50		0,68				
------	----------------------	-------	-----	----	--	------	--	--	--	--

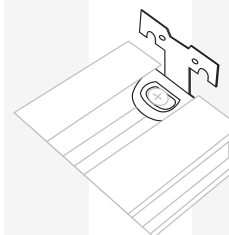

DISTANZIATORE PIASTRELLE PER TRAVETTO IN ALLUMINIO

K2D5	DK-DISTANZIATORE TRAVETTI ALLUMINIO	0,30	PZ	1		0,04				
------	-------------------------------------	------	----	---	--	------	--	--	--	--

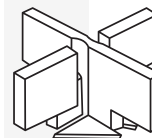

CLIP TAMPONAMENTO VERTICALE

K2D4	DK-CLIP TAMPONAMENTO VERTICALE TESTA 16,80		PZ	1		0,07				
------	--	--	----	---	--	------	--	--	--	--

K2D3	DK-CLIP TAMPONAMENTO VERTICALE BASE 14,20									
------	---	--	--	--	--	--	--	--	--	--

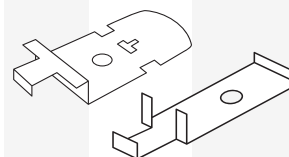

CONDIZIONI GENERALI DI VENDITA / Rev.1a - 01 Gennaio 2018

A. - MODALITA' DI CONCLUSIONE DEL CONTRATTO

A.1.- Le presenti Condizioni Generali di Vendita disciplinano ogni contratto di Vendita tra il Venditore e l'Acquirente ed ogni loro modifica o deroga deve essere concordata per iscritto.
A.2.- Eventuali offerte, accrediti e/o abbuoni accordati da agenti o da altri intermediari, non sono ritenuti validi se non confermati per iscritto dal Venditore.
A.3.- L'Acquirente invia al Venditore, direttamente o per il tramite di agenti, Ordini scritti che devono contenere l'indicazione dei codici dei Prodotti richiesti, delle quantità, del loro prezzo e della destinazione. L'Ordine inviato dall'Acquirente è irrevocabile.
A.4.- La Vendita dovrà ritenersi conclusa nel momento in cui: (i) l'Acquirente riceve da parte del Venditore una Conferma scritta via e-mail, fax o altri mezzi telematici, conforme ai termini e alle condizioni dell'Ordine; o (ii) in caso di Conferma inviata dal Venditore contenente condizioni difformi dall'Ordine ricevuto dall'Acquirente quando questi l'acchetti per iscritto o comunque non la contesti entro 7 (sette) giorni dalla ricezione; o (iii) in assenza di conferma scritta da parte del Venditore, nel momento in cui i Prodotti saranno consegnati e caricati dall'Acquirente.

B. - PREZZI

B.1.- Salvo diversa pattuizione scritta, i prezzi di vendita concordati di volta in volta si intendono al netto per contanti e per consegna franco stabilimento del Venditore indicato nella Conferma d'Ordine.

C. - CARATTERISTICHE DEI PRODOTTI

C.1.- L'Acquirente dichiara di aver preso visione ed attenersi al contenuto della seguente documentazione pubblicata nel sito internet aziendale: 1) Manuale di Posa, Uso, Pulizia e Manutenzione e 2) Schede tecniche.
C.2. Data la intrinseca variabilità del prodotto ceramico, le caratteristiche dei campioni e/o modelli inviati in precedenza dal Venditore all'Acquirente sono da considerarsi indicativi e non vincolanti.
C.3. Salvo specifiche richieste da concordare prima della Conferma d'Ordine, il Venditore non garantisce che l'ordine del singolo articolo venga evaso tutto con un medesimo lotto di produzione.

D. - TERMINI DI CONSEGNA

D.1.- I termini di consegna sono da intendersi indicativi e la proroga di essi non può far maturare all'Acquirente alcun diritto a richiedere indennizzi, ogni eccezione rimossa.
D.2.- Se, trascorsi 10 (dieci) giorni dalla data di avviso di merce pronta, l'Acquirente non ritira il materiale, il Venditore si riserva di stabilire discrezionalmente un nuovo termine di consegna.

E. - RESA E SPEDIZIONE

E.1.- L'eventuale variazione della destinazione dei Prodotti, diversa da quella concordata in Conferma d'Ordine, deve essere comunicata dall'Acquirente per iscritto entro e non oltre il secondo giorno antecedente a quello previsto per il ritiro presso la sede del Venditore. Il Venditore si riserva la facoltà di non accettare la variazione della destinazione dei Prodotti. Nel caso si verifichi che la destinazione effettiva del Prodotto sia stata diversa da quella dichiarata dall'Acquirente, il Venditore si riserva la facoltà di sospendere l'esecuzione delle forniture in corso e/o risolvere i contratti in corso senza che l'Acquirente possa rivendicare risarcimenti diretti e/o indiretti di alcun tipo.
E.2.- Salvo patto contrario, la fornitura della merce si intende Franco Fabbrica (EXW ai sensi degli Incoterms 2010) e ciò anche quando sia convenuto che la spedizione o parte di essa venga curata dal Venditore su mandato dell'Acquirente. In ogni caso i rischi passano all'Acquirente al più tardi con la consegna al primo trasportatore.
E.3.- Ferma restando l'estraneità del Venditore rispetto al contratto di trasporto, il Venditore non potrà essere indicato come "shipper" nella polizza di carico. La comunicazione del peso lordo del container allo spedizioniere, non costituisce alcuna assunzione di responsabilità da parte del Venditore ai fini della Convenzione SOLAS (Safety Of Life At Sea). In nessun caso tale comunicazione potrà essere intesa come VGM (Verified Gross Mass).

E.4.- L'Acquirente s'impegna affinché il mezzo inviato presso i magazzini del Venditore sia idoneo al carico in relazione alla natura dei Prodotti. Nel caso il mezzo che si presenta comporti significative difficoltà per le operazioni di carico, il Venditore si riserva di addebitare una penale pari al 4% del valore dei prodotti a copertura dei maggiori costi logistici. Se il mezzo convenuto non è assolutamente idoneo, il Venditore si riserva la facoltà di negare le operazioni di carico senza che nulla possa essere richiesto dall'Acquirente a titolo di risarcimento per ogni onere diretto e/o indiretto che ne possa derivare.

E.5.- È compito dell'Acquirente incaricare il vettore di controllare i prodotti prima del carico; eventuali osservazioni in relazione all'integrità degli imballi e della rispondenza delle quantità caricate a quelle indicate sul documento di trasporto, devono essere sollevate dal vettore al momento del carico. Tali osservazioni devono essere riportate su tutte le copie dei documenti di trasporto, altrimenti i prodotti caricati s'intendono integri e completi. Ne deriva che il Venditore non si assume alcuna responsabilità in relazione a mancanze o danni dei prodotti non segnalati dal vettore.

E.6.- È altresì responsabilità dell'Acquirente incaricare il vettore di verificare le modalità e la stabilità del carico sul mezzo affinché durante il trasporto non si verifichino rotture e affinché siano rispettate tutte le disposizioni di sicurezza riguardanti la circolazione stradale.

F. - PAGAMENTI

F.1.- Qualsiasi obbligazione di pagamento deve essere adempiuta presso la sede legale del Venditore. Eventuali pagamenti ad agenti, rappresentanti o ausiliari di commercio non si intendono effettuati finché le relative somme non pervengono al Venditore.
F.2.- È fatto divieto all'Acquirente di eseguire il proprio adempimento mediante pagamenti provenienti da paesi diversi dal proprio paese di residenza se trattati di paesi che non garantiscono un adeguato scambio di informazioni con l'Italia. In caso di violazione di tale divieto, il Venditore ha facoltà di risolvere il contratto per giusta causa senza che l'Acquirente possa vantare il diritto di ottenere alcun risarcimento per l'eventuale danno subito.

F.3.- Eventuali spese di bolle ed incasso effetti e tratte sono a carico dell'Acquirente. In caso di inadempimento, anche solo parziale, del giorno fissato per il pagamento decorreranno a favore del Venditore gli interessi moratori nella misura prevista dal d.lgs. 09/10/2002 n. 231.
F.4.- Salvo diversi accordi scritti l'Acquirente si impegna a non compensare alcun credito, comunque insorto, nei confronti del Venditore.

G. - RECLAMI

G.1.- Al ricevimento dei Prodotti, l'Acquirente dovrà sottoporli ad accurato controllo attraverso un esame visivo effettuato conformemente alle indicazioni riportate al punto 7 delle norme UNI EN ISO 10545-2.
G.2.- L'installazione e la posa dei Prodotti deve essere effettuata attenendosi scrupolosamente alle raccomandazioni inerenti le attività da svolgere prima e durante la posa in opera indicate nel documento 1) Manuale di Posa, Uso, Pulizia e Manutenzione pubblicato nel sito internet del Venditore e sulla confezione del prodotto e/o all'interno della stessa. Non sono considerati vizi del Prodotto quelli generati da un'errata installazione e dalla mancata/errata manutenzione (difformi dalle indicazioni fornite nel 1) Manuale di Posa, Uso, Pulizia e Manutenzione), da una non idonea destinazione d'uso e/o dalla normale usura nel tempo.

G.3.- Fatti salvi i limiti di accettabilità previsti dalla norma internazionale EN 14411 (ISO 13006), le Parti riconoscono come Vizi Palesi i difetti dei Prodotti riscontrabili già al momento del loro ricevimento tali da rendere il materiale inidoneo all'uso o da diminuirne in modo apprezzabile il valore. Rientrano in tale categoria i difetti come definiti nel documento 1) Manuale di Posa, Uso, Pulizia e Manutenzione pubblicato nel sito internet del Venditore. A titolo esemplificativo e non esaustivo si riconoscono come Vizi Palesi i difetti superficiali, i difetti di decorazione, di lappatura/levigatura, di calibro, di planarità, di ortogonalità-rettilineità, di spessore, le crepe, le sbecature, i fuori tono, i toni mescolati e i Prodotti che presentano problemi da taglio/scaglie.

G.4.- Nel caso l'Acquirente rilevi Vizi Palesi dovrà fare reclamo al Venditore per iscritto, a pena di decadenza, entro 8 (otto) giorni dal ricevimento e tenere a disposizione del Venditore l'intera partita di materiale. Il reclamo dovrà riportare i dati di fatturazione e una precisa descrizione del vizio reclamato corredata, quando possibile, da immagini fotografiche. Qualora il reclamo dovesse risultare infondato, l'Acquirente si rende disponibile a risarcire il Venditore delle spese sostenute per l'eventuale sopralluogo (perizie, viaggi, ecc).
G.5.- I Vizi Occulti dovranno essere notificati al Venditore mediante lettera raccomandata A.R., a pena di decadenza dalla garanzia, entro 8 (otto) giorni CONDIZIONI GENERALI DI VENDITA / Rev.1a - 01 Gennaio 2018 dalla data della scoperta del difetto.

G.6.- L'azione dell'Acquirente diretta a fare valere la garanzia per vizi si prescrive comunque nel termine di 12 (dodici) mesi decorrenti dalla consegna dei Prodotti.

H. - GARANZIA PER VIZI

H.1. La garanzia del Venditore si intende limitata ai soli Prodotti di prima scelta e non ai Prodotti di seconda o terza scelta o di partite d'occasione con prezzi o sconti particolari quando debitamente segnalati in nota nella Conferma dell'Ordine.
H.2. Il Venditore non garantisce l'idoneità dei Prodotti ad usi particolari, ma soltanto le caratteristiche tecniche pubblicate nel sito internet nel documento 2) Schede tecniche.

L'indicazione d'uso, anche quando presentata dal Venditore in cataloghi e manuali, è da ritenersi puramente indicativa. Sulla base delle caratteristiche tecniche riportate nelle 2) Schede Tecniche è sempre compito del progettista valutare l'idoneità del Prodotto alle condizioni specifiche di utilizzo in funzione delle sollecitazioni e delle variabili che si possono verificare nell'ambiente di destinazione alterandone le sue caratteristiche, a titolo d'esempio, all'intensità del traffico, alla qualità del traffico (calpestio in presenza di sabbia, di detriti...) alle eventuali condizioni climatiche avverse e a qualsiasi altra aleatorietà a cui può essere esposto il materiale.

H.3.- Nel caso risulti accertato che il Prodotto manifesti Vizi Palesi, come definiti al sub lett. G n.3, il Venditore provvederà alla sostituzione del Prodotto difettoso con altro avente caratteristiche pari o superiori o nel caso ciò non sia possibile ad una congrua riduzione del prezzo. In alternativa l'Acquirente avrà diritto, previa restituzione dei Prodotti viziati, al rimborso del prezzo pagato, maggiorato del costo del trasporto, con esclusione del risarcimento di ogni altro danno diretto e/o indiretto.

H.4. La garanzia del Venditore deve ritenersi esclusa nel caso in cui il Prodotto affetto da Vizi Palesi (in tutto o in parte) sia stato utilizzato e/o comunque trasformato dovendosi ritenere che in tal modo l'Acquirente (o il suo cliente) abbia espresso la volontà di accettarli nello stato in cui si trovano.
H.5. Nel caso risulti accertato che il Prodotto manifesti Vizi Occulti, la garanzia del Venditore è limitata alla sostituzione del materiale con altro avente caratteristiche pari o superiori e ove ciò non sia possibile al rimborso del prezzo pagato maggiorato del costo del trasporto. In ogni caso la garanzia del Venditore per ogni danno diretto e/o indiretto comunque originato dal prodotto difettoso, deve intendersi limitata ad una somma che non potrà superare il doppio del prezzo di vendita applicato dal Venditore in relazione alla sola parte della fornitura difettosa.

H.6.- Nel caso l'Acquirente rivenda il Prodotto a soggetti tutelati dal codice del consumo (d.l. n.206/2005) sarà responsabile delle condizioni praticate se difformi da quelle qui riportate e dovrà accertarsi che i diritti del consumatore siano esercitati nel rispetto dei rimedi e dei termini fissati da tale codice. Nel caso sussistano i presupposti, il diritto di regresso e/o comunque di rivalsa spettanti all'Acquirente verso il Venditore/produttore non potrà eccedere le esenzioni ed i limiti come fissati dal sub lett. G n.1 al sub lett. H n.5.

I.1. CLAUSOLE SOLVE ET REPETE E RISOLUTIVE
I.1.- Ai sensi dell'art. 1462 del Codice Civile, per nessun motivo, ivi compresi pretesi vizi o difetti del materiale, l'Acquirente potrà sospendere o ritardare il pagamento del materiale ritirato, salva naturalmente la facoltà di ripetere quando possa dimostrare di avere indebitamente pagato.

I.2.- Nel caso di mutamento delle condizioni patrimoniali dell'Acquirente o di mancato pagamento anche parziale di prodotti già forniti, il Venditore può sospendere l'esecuzione delle forniture in corso e/o risolvere i contratti in corso senza che l'Acquirente possa rivendicare risarcimenti diretti e/o indiretti di alcun tipo.

L. - PATTO DI RISERVATO DOMINIO
L.1.- Fino a quando l'Acquirente non avrà provveduto all'integrale pagamento del prezzo, i Prodotti oggetto della fornitura rimarranno di proprietà del Venditore.
L.2.- Durante il periodo suddetto, l'Acquirente assumerà gli obblighi e le responsabilità del custode, e non potrà alienare, dare in uso, lasciare sequestrare o pignorare tali Prodotti senza dichiarare la proprietà del Venditore e dare immediato avviso a mezzo raccomandata A.R.

M. - FORZA MAGGIORE

M.1.- Ciascuna parte potrà sospendere l'esecuzione dei suoi obblighi contrattuali quando tale esecuzione sia resa impossibile o oggettivamente troppo onerosa da un impedimento imprevedibile indipendente dalla sua volontà, quale ad esempio: sciopero, boicottaggio, serrata, incendio, guerra (dichiarata o non), guerra civile, sommosse e rivoluzioni, requisizioni, embargo, interruzioni di energia, rotture straordinarie di macchinari, ritardi nella consegna di componenti o materie prime.
M.2.- La parte che desidera avvalersi della presente clausola dovrà comunicare immediatamente per iscritto all'altra parte il verificarsi e la cessazione delle circostanze di forza maggiore.

M.3.- Qualora la sospensione dovuta a forza maggiore duri più di 60 (sessanta) giorni, ciascuna parte avrà il diritto di risolvere il presente contratto, previo un preavviso di 10 (dieci) giorni, da comunicarsi alla controparte per iscritto.

N. - OBBLIGO DI RISERVATEZZA

N.1.- L'Acquirente è tenuto ad osservare la più assoluta riservatezza su tutte le notizie di carattere tecnico (quali, in via meramente esemplificativa, disegni, prospetti, documentazioni, formule e corrispondenza) e di carattere commerciale (ivi comprese le condizioni contrattuali, i prezzi d'acquisto, le condizioni di pagamento ...) apprese in esecuzione del presente Contratto.
N.2.- L'obbligo di riservatezza viene assunto per tutta la durata del Contratto, nonché per il periodo successivo alla sua esecuzione. N.3.- In ogni caso di inosservanza dell'obbligo di riservatezza, la parte inadempiente è tenuta a risarcire all'altra tutti i danni che ne dovessero derivare.

O. - MARCHI E SEGNI DISTINTIVI DEL VENDITORE

O.1.- L'utilizzo dei marchi, dei modelli ornamentali e delle opere d'ingegno in genere, in qualunque forma o modo di espressione (quali a titolo meramente esemplificativo, ma non esaustivo: immagini, foto, disegni, filmati, figure, strutture, etc.) costituenti proprietà intellettuale del Venditore, attraverso qualsiasi mezzo (quali a titolo meramente esemplificativo, ma non esaustivo: stampa, video, radio, internet, social media, piattaforme di messaggistica istantanea o VoIP, etc.) è severamente vietato. Qualsiasi deroga a tale divieto, anche solamente parziale, dovrà essere autorizzata per iscritto, caso per caso, dalla Direzione generale del Venditore.

P. - LINGUA DEL CONTRATTO, LEGGE APPLICABILE, GIURISDIZIONE E COMPETENZA
P.1.- Il Contratto e le presenti condizioni sono redatti in lingua italiana, la quale prevarrà nel caso di divergenza con la traduzione in altre lingue.
P.2.- La definizione di qualsiasi controversia comunque relativa alle forniture è soggetta alla legge ed alla giurisdizione dello Stato Italiano e la competenza territoriale viene devoluta in via esclusiva al Tribunale di Modena nella cui circoscrizione il Venditore ha la sua sede legale.

GENERAL CONDITIONS OF SALES / Rev.1a - 1st January 2018

A. - CONTRACT COMPLETION

A.1.- These general sales conditions govern every sales contract between the Seller and the Buyer and any amendment or exception thereof shall be agreed in writing.
A.2.- Any offers, credits and/or rebates granted by agents or other intermediaries, shall not be considered valid if they are not confirmed in writing by the Seller.
A.3.- The Buyer shall send the written orders to the Seller, directly or through the agents, and the orders shall include the codes of the required products, quantity, price and destination. The order sent by the Buyer is irrevocable.
A.4.- The sale shall be deemed completed when: (i) the Buyer receives a written confirmation from the Seller, via e-mail, fax or other electronic means, that complies with the terms and conditions of the order; or (ii) if the confirmation sent by the Seller contains conditions that differ from the order sent by the Buyer, when the latter accepts it in writing or in any case does not object within 7 (seven) days from reception; or (iii) if the Seller does not provide a written confirmation, when the products are delivered and loaded by the Buyer.

B. - PRICES

B.1.- The prices agreed upon for each individual sale are net prices for cash delivery ex works (the Seller's plant shall be specified in the order confirmation), unless otherwise agreed in writing.

C. - PRODUCT CHARACTERISTICS

C.1.- The Buyer declares to have read and comply with the content of the following documentation published on the corporate website: 1) Laying, use, cleaning and maintenance manual and 2) Technical data sheets.
C.2. Given the intrinsic variability of the ceramic products, the characteristics of the samples, previously sent by the Seller to the Buyer, are purely illustrative and cannot be deemed binding.
C.3. Unless specifically requested and agreed before the order confirmation, the Seller does not guarantee that the entire quantity of an article on order shall be sent from one same production lot.

D. - DELIVERY TERMS

D.1.- The delivery terms are approximate and a delay does not give the Buyer any right to claim compensation, without any exception.
D.2.- If the Buyer does not collect the goods, after 10 (ten) days from the date of the "goods ready" notice, the Seller has the right - at its discretion - to establish a new delivery date.

E. - SHIPPING ARRANGEMENTS AND TERMS

E.1.- The Buyer must communicate any variation in the destination of the products, different from the one agreed in the order confirmation, in writing within, and no later than, the second day before the day foreseen for the collection at the Seller's premises. The Seller reserves the right not to accept the change of the product destination. If the actual destination of the product is different from the one stated by the Buyer, the Seller reserves the right to suspend the execution of the supplies underway and/or to terminate the contracts in force and the Buyer shall not have the right to claim direct and/or indirect compensation of any type.
E.2.- Unless otherwise agreed, the goods shall be delivered ex-works (EXW - Incoterms 2010) and this shall also be the case when the parties agree that the delivery, or part of it, shall be arranged by the Seller on the Buyer's behalf. In any case, the risks shall transfer to the Buyer upon delivery to the first carrier.
E.3.- Without prejudice to the Seller's extraneity in relation to the transport contract, the Seller shall not be indicated as "shipper" on the bill of lading. The communication of the gross weight of the container to the Forwarding agent does not represent in any way the undertaking of any liability by the Seller as regards the SOLAS (Safety Of Life At Sea) Convention. In no event may the said communication be taken to be the VGM (Verified Gross Mass).
E.4.- The Buyer undertakes to ensure that the vehicle sent to the Seller's warehouse is suitable for the loading operations, considering the nature of the products. If the vehicle sent to collect the goods causes difficulties in the loading operations, the Seller reserves the right to charge a penalty, of 4% of the value of the products, to cover the extra logistics costs. If the vehicle sent is not at all suitable, the Seller reserves the right to refuse to load the goods and the Buyer shall not have the right to claim compensation for any direct and/or indirect cost that may arise therefrom.
E.5.- The Buyer is responsible for assigning the carrier the task of checking the products before loading them; any observations concerning the condition of the packaging and the correspondence of the quantities loaded with those on the transport document must be made by the carrier upon collection of the goods. The said observations must be written on all the copies of the transport documents, otherwise the loaded products shall be considered to be complete and in good condition. As a result, the Seller shall not be liable for any missing or damaged products not reported by the carrier.
E.6.- The Buyer is also responsible for assigning the carrier the task of checking the loading procedure and the stability of the goods on the vehicle, in order to prevent damage during transport and to comply with all road safety provisions.

F. - PAYMENTS

F.1. - PAYMENTS

F.1.- All payments must be made to the Seller's registered office. Payments made to agents, representatives, or sales assistants shall not be considered as made until the amounts are received by the Seller.
F.2.- The Buyer shall not fulfil its payment obligations by making payments from countries other than its own country of residence, if the said countries do not guarantee an adequate exchange of information with Italy. In case of breach of the said prohibition, the Seller has the right to terminate the contract for just cause and the Buyer shall not have the right to claim compensation for any damage suffered.
F.3.- Any costs for stamp duty and bank draft fees shall be borne by the Buyer. Failure to fulfil, even only in part, the payment shall result in the application of interest on arrears in favour of the Seller, from the date established for the payment, as envisaged by legislative decree 09/10/2002 no. 231.
F.4.- Unless otherwise agreed in writing, the Buyer undertakes not to offset any receivables, of whatever nature, owed by the Seller.

F.2. - CLAIMS

G.1.- Upon receipt of the products, the Buyer shall perform a visual inspection in compliance with instructions provided in point 7 of UNI EN ISO 10545- 2 standards. G.2.- The products must be installed and fitted strictly respecting the recommendations related to the activities to be performed before and during the laying of the product specified in document 1) Laying, use, cleaning and maintenance manual, published on the Seller's website, and on the product packaging and/or inside the packaging. Faults caused by an incorrect installation and by missing/incorrect maintenance (different from instructions provided in document 1) Laying, use, cleaning and maintenance manual), by an unsuitable use and/or by normal wear over time shall not be considered product faults.
G.3.- With the exception of the limits of acceptability foreseen by the international EN 14411 (ISO 13006) standard, the parties acknowledge as identifiable faults those product defects that are immediately visible upon receipt thereof and that make the material unsuitable for use or that significantly reduce its value. This category includes faults as defined in the document 1) Laying, use, cleaning and maintenance manual, published on the Seller's website. Identifiable faults include, by way of a non-limiting example, superficial defects, decoration defects, defects concerning polishing, dimensions, surface flatness, straightness of sides/rectangularity and thickness, cracks, chippings or rough edges, non-compliant shades, mixed shades and products that feature problems deriving from the cutting process and/or from chips.
G.4.- If the Buyer finds an identifiable fault, it must be reported in writing to the Seller, within 8 (eight) days from receipt of the products; failure to send the claim shall result in the forfeiture and loss of such right. The Buyer shall keep the entire lot of material readily available for the Seller. The claim shall include the invoice details and an accurate description of the claimed fault together with photographs, where possible. In the event that the claim proves to be unfounded, the Buyer shall refund the Seller any costs incurred for an inspection (expert's reports, travel, etc.).
G.5.- Hidden faults shall be notified to the Supplier in writing, by recorded delivery letter with advice of receipt, within 8 days from the date such fault is GENERAL CONDITIONS OF SALES / Rev.1a - 1st January 2018 found, under penalty of forfeiture.
G.6.- The Buyer's right to make a claim for faults under warranty is valid for 12 (twelve) months from the delivery of the products.

H. - WARRANTY FOR FAULTS

H.1. The Seller's warranty is limited to first grade products and not second or third grade products or lots on offer with special prices or discounts, which must be duly specified with a note in the order confirmation.
H.2. The Seller does not guarantee the suitability of the products for particular uses, and only guarantees the technical specifications published on the website in the document 2) Technical data sheets. The indication for use is merely indicative, even when written in the Seller's catalogues and manuals. On the basis of the characteristics described in the document 2) Technical data sheets, the Buyer always has the task of assessing the suitability of the product for the specific use conditions, taking into account the stress and variables to which the product will be subjected, which may alter its characteristics; for example, the traffic intensity, quality of traffic (foot traffic with the presence of sand, debris...), adverse weather conditions and any other unpredictable factor to which the material may be exposed.
H.3.- In the event that identifiable product faults are ascertained, as defined in sub section G no. 3, the Seller shall replace the faulty product with another one with equal or superior characteristics; should this not be possible, the Seller shall apply a significant price reduction. Alternatively, following the return of the faulty products, the Buyer shall have the right to a refund of the price paid plus the transport cost, with the exclusion of compensation for any other direct and/or indirect damage.
H.4. The Seller's warranty shall not be valid if the products that have identifiable faults (totally or in part) have been used and/or in any case transformed, as this entails that the Buyer (or its customer) expressed the intention to accept them in the condition in which they were found.
H.5.- In the event that hidden product faults are ascertained, the Seller's warranty is limited to the replacement with other products of equal or superior characteristics; should this not be possible the Seller shall refund the price paid plus the transport cost. In any case, the Seller's warranty for any direct and/or indirect damage caused by the faulty product, shall be limited to an amount that shall not be greater than double the selling price applied by the Seller, only in relation to the faulty part of the supply.
H.6.- In the event that the Buyer resells the product to subjects protected by the consumer code (law decree no. 206/2005), the former shall be responsible for the conditions applied, if different from those stated herein, and shall ensure that the consumer's rights are exercised, in relation to the remedies and terms established by the said code. If there are the grounds for the Buyer to exercise the right of recourse and/or make a claim against the Seller/manufacturer, the said action shall take into account or go beyond the exemptions and limits established in sub sections G no. 1 and H no. 5.

I. SOLVE ET REPETE (pay and then claim) AND TERMINATION CLAUSES

I.1.- Pursuant to article 1462 of the Italian Civil Code, on no account may the Buyer suspend or delay payment of collected material, including in the event of alleged defects or faults in the material; this does not affect the right to claim back any payments made unduly (solve et repete).
I.2.- If the Buyer's financial situation changes or in the event of non-payment (even partial) of products already supplied, the Seller reserves the right to suspend the execution of the supplies underway and/or to terminate the contracts in force and the Buyer shall not have the right to claim direct and/or indirect compensation of any type.

L. - RETENTION OF OWNERSHIP

L.1.- The products supplied shall remain exclusive property of the Seller until the Buyer has paid the full amount.
L.2.- During the aforementioned period, the Buyer shall undertake the obligations and responsibilities as bailee (also referred to as custodian) and shall not transfer the said products, grant their use, let them be seized or distrained without declaring that the property is of the Seller, and the Buyer shall immediately inform the Seller by recorded delivery letter with advice of receipt.

M. - FORCE MAJEURE

M.1.- Each party may suspend the fulfilment of its contractual obligations, when the said fulfilment is impossible or objectively too costly due to an unforeseeable impediment independent from the parties, such as for example: strike, boycott, lockout, fire, war (declared or not), civil war, riots and revolutions, requisitions, embargo, power blackouts, extraordinary breakage of machinery, delays in the delivery of components or raw materials.
M.2.- The party that wishes to apply this clause shall immediately notify the onset and end of the circumstances of force majeure to the other party in writing.
M.3.- If the suspension due to force majeure lasts longer than 60 (sixty) days, each party shall have the right to terminate this contract, with a notice of 10 (ten) days to be notified to the counterparty in writing.

N. - CONFIDENTIALITY

N.1.- The Buyer undertakes to maintain confidentiality as regards all information of a technical (such as, by way of a non-limiting example, drawings, tables, documentation, formulas and correspondence) and commercial nature (including contractual conditions, purchase prices, payment conditions...) gained during the performance of this contract.
N.2.- The confidentiality obligation shall be undertaken for the entire duration of this contract and for the period following its execution.
N.3.- In case of failure to uphold the confidentiality obligation, the non-fulfilling party shall pay the other party compensation for all damages that may derive therefrom.

O. - SELLER'S TRADEMARKS AND DISTINCTIVE SIGNS

O.1.- The use of trademarks, ornamental designs and creative works in general, in whatever form and manner of expression (such as, by way of a nonlimiting example: images, photos, drawings, videos, shapes, structures, etc.) constituting the Seller's intellectual property, through any means (such as, by way of a non-limiting example: press, video, radio, internet, social media, instant messaging platforms or VoIP, etc.) is strictly forbidden. Any exception to the said prohibition, even only partial, must be authorised in writing, each time, by the Seller's general management.

P. - CONTRACT LANGUAGE, APPLICABLE LAW, JURISDICTION AND AUTHORITY

P.1.- The present CONTRACT is drafted in Italian, and in case of disputes the said version shall prevail over any translations in other languages.
P.2.- Any dispute concerning the supply of products shall be subject to Italian law and jurisdiction and the Court of Modena, the town in which the Seller has its registered office, shall have sole local jurisdiction.

CONDITIONS GÉNÉRALES DE VENTE / Rév.1a - 01 Janvier 2018

A.- MODALITÉS DE CONCLUSION DU CONTRAT

A.1.- Les présentes Conditions Générales de Vente régissent tout contrat de Vente entre le Vendeur et l'Acheteur et toute modification ou dérogation de ces dernières doit être convenue par écrit.
A.2.- D'éventuelles offres, accreditations et / ou ristournes accordées par des agents ou par d'autres intermédiaires, ne seront réputées valables que si elles sont confirmées par écrit par le Vendeur.
A.3.- L'acheteur envoie au Vendeur, directement ou par l'intermédiaire d'agents, des Commandes écrites qui doivent indiquer les codes des Produits demandés, les quantités, leur prix et leur destination. La commande envoyée par l'acheteur est irrévocable.
A.4.- La Vente doit être réputée conclue au moment où : (i) l'acheteur reçoit de la part du Vendeur une Confirmation écrite par e-mail, par télécopie ou par d'autres moyens télématiques, conforme aux conditions de la Commande ; ou (ii) en cas de Confirmation envoyée par le Vendeur contenant des conditions différant de la Commande envoyée par l'acheteur lorsque celui-ci l'accepte par écrit ou qu'il en soit s'il ne la conteste pas dans un délai de 7 (sept) jours à compter de la réception ; ou (iii) en l'absence d'une confirmation écrite de la part du Vendeur, au moment où les Produits seront livrés et chargés par l'acheteur.

B.- PRIX

B.1.- Sauf accord contraire, les prix de vente convenus au fur et à mesure sont réputés nets, pour les paiements en espèces et les livraisons Franco l'établissement du Vendeur indiqué sur la Confirmation de Commande.

C.- CARACTÉRISTIQUES DES PRODUITS

C.1.- L'acheteur déclare avoir lu et s'en tenir au contenu de la documentation suivante publiée sur le site Internet de la société: 1) Manuel de Pose, d'Utilisation, de Nettoyage et d'Entretien et 2) Fiches techniques. C.2. Vu la variabilité intrinsèque du produit en céramique, les caractéristiques des échantillons et / ou des modèles envoyés précédemment par le Vendeur à l'acheteur sont indicatifs et non contraignants.

C.3. Sauf en cas de demandes spécifiques à convenir avant la Confirmation de Commande, le Vendeur ne garantit pas la commande d'un article soit intégralement constituée par un même lot de production.

E.- LIVRAISON ET EXPÉDITION

E.1.- L'éventuelle variation de la destination des Produits, différente de celle convenue dans la Confirmation de Commande, doit être communiquée par l'acheteur par écrit au plus tard le second jour qui précède le jour du retrait au siège du Vendeur. Le Vendeur se réserve la faculté de ne pas accepter la variation de la destination des Produits. Au cas où la destination effective du Produit serait différente de celle déclarée par l'acheteur, le Vendeur se réserve la faculté de suspendre l'exécution des fournitures en cours et / ou de résilier le contrat sans que l'acheteur puisse revendiquer des indemnités directes et / ou indirectes d'aucune sorte.

E.2.- Sauf accord contraire, la fourniture de la marchandise est livrée Départ Usine (EXW aux termes des Incoterms 2010) même si l'on a convenu que l'expédition ou une partie de cette dernière sera suivie par le Vendeur sur mandat de l'acheteur. En tout état de cause, les risques passent à l'acheteur au plus tard au moment de la livraison au premier transporteur.

E.3.- Sans préjudice du désintéressé du Vendeur par rapport au contrat de transport, celui-ci ne pourra être indiqué comme le "shipper" dans le connaissance. La communication du poids brut du conteneur à l'expéditeur, ne constitue pas une prise de responsabilité de la part du Vendeur aux fins de la Convention SOLAS (Safety Of Life At Sea). En aucun cas cette communication ne pourra être considérée comme le VGM (Verified Gross Mass).

E.4.- L'acheteur s'engage à ce que le véhicule envoyé aux entrepôts du Vendeur soit compatible avec la nature des Produits à charger. Si le véhicule qui se présente comporte des difficultés significatives pour les opérations de chargement, le Vendeur se réserve la faculté de débiter une pénalité de l'ordre de 4 % de la valeur des produits pour couvrir les coûts logistiques supplémentaires. Si le véhicule convenu n'est absolument pas compatible, le Vendeur se réserve la faculté de refuser les opérations de chargement sans que l'acheteur ne puisse rien lui demander à titre de remboursement de toute dépense directe et / ou indirecte éventuelle.

E.5.- Il appartient à l'acheteur de charger le transporteur de contrôler les produits avant le chargement ; d'éventuelles observations concernant l'intégrité des emballages et la correspondance des quantités chargées avec celles indiquées sur le document de transport doivent être soulevées par le transporteur au moment du chargement. Ces observations doivent être indiquées sur toutes les copies des documents de transport ; dans le cas contraire, les produits chargés sont réputés intacts et complets. Il s'ensuit que le Vendeur décline toute responsabilité en cas d'absence ou de détérioration des produits non signalée par le transporteur.

E.6.- L'acheteur a également la responsabilité de charger le transporteur de vérifier les modalités et la stabilité du chargement

D.- DÉLAIS DE LIVRAISON

D.1.- Les délais de livraison s'entendent fournis à titre indicatif et leur prorogation ne donne en aucun cas le droit à l'acheteur de demander des indemnités, excluant dès à présent toute exception. D.2.- Si l'acheteur ne retire pas le matériel, au bout d'un délai de 10 (dix) jours à compter de la date de l'annonce indiquant que la marchandise est prête, le Vendeur se réserve la faculté de fixer à sa discrétion un nouveau délai de livraison.

E.- LIVRAISON ET EXPÉDITION

E.1.- L'éventuelle variation de la destination des Produits, différente de celle convenue dans la Confirmation de Commande, doit être communiquée par l'acheteur par écrit au plus tard le second jour qui précède le jour du retrait au siège du Vendeur. Le Vendeur se réserve la faculté de ne pas accepter la variation de la destination des Produits. Au cas où la destination effective du Produit serait différente de celle déclarée par l'acheteur, le Vendeur se réserve la faculté de suspendre l'exécution des fournitures en cours et / ou de résilier le contrat sans que l'acheteur puisse revendiquer des indemnités directes et / ou indirectes d'aucune sorte.

E.2.- Sauf accord contraire, la fourniture de la marchandise est livrée Départ Usine (EXW aux termes des Incoterms 2010) même si l'on a convenu que l'expédition ou une partie de cette dernière sera suivie par le Vendeur sur mandat de l'acheteur. En tout état de cause, les risques passent à l'acheteur au plus tard au moment de la livraison au premier transporteur.

E.3.- Sans préjudice du désintéressé du Vendeur par rapport au contrat de transport, celui-ci ne pourra être indiqué comme le "shipper" dans le connaissance. La communication du poids brut du conteneur à l'expéditeur, ne constitue pas une prise de responsabilité de la part du Vendeur aux fins de la Convention SOLAS (Safety Of Life At Sea). En aucun cas cette communication ne pourra être considérée comme le VGM (Verified Gross Mass).

E.4.- L'acheteur s'engage à ce que le véhicule envoyé aux entrepôts du Vendeur soit compatible avec la nature des Produits à charger. Si le véhicule qui se présente comporte des difficultés significatives pour les opérations de chargement, le Vendeur se réserve la faculté de débiter une pénalité de l'ordre de 4 % de la valeur des produits pour couvrir les coûts logistiques supplémentaires. Si le véhicule convenu n'est absolument pas compatible, le Vendeur se réserve la faculté de refuser les opérations de chargement sans que l'acheteur ne puisse rien lui demander à titre de remboursement de toute dépense directe et / ou indirecte éventuelle.

E.5.- Il appartient à l'acheteur de charger le transporteur de contrôler les produits avant le chargement ; d'éventuelles observations concernant l'intégrité des emballages et la correspondance des quantités chargées avec celles indiquées sur le document de transport doivent être soulevées par le transporteur au moment du chargement. Ces observations doivent être indiquées sur toutes les copies des documents de transport ; dans le cas contraire, les produits chargés sont réputés intacts et complets. Il s'ensuit que le Vendeur décline toute responsabilité en cas d'absence ou de détérioration des produits non signalée par le transporteur.

E.6.- L'acheteur a également la responsabilité de charger le transporteur de vérifier les modalités et la stabilité du chargement sur le véhicule afin d'éviter les bris durant le transport et le respect de tous les dispositifs de sécurité concernant la circulation sur route.

F.- PAIEMENTS

F.1.- Toute obligation de paiement doit être accomplie au siège légal du Vendeur. Les éventuels paiements remis à des agents, à des représentants ou à des auxiliaires de commerce ne seront réputés effectués qu'au moment où le Vendeur percevra les sommes correspondantes. F.2.- Il est interdit à l'acheteur d'effectuer des paiements depuis un pays différent de son pays de résidence et ne garantissant pas un échange d'informations correct avec l'Italie. En cas de violation de cette interdiction, le Vendeur a la faculté de résilier le contrat pour juste cause sans que l'acheteur ne puisse revendiquer le droit d'obtenir une quelconque réparation pour l'éventuel préjudice subi.

F.3.- Les éventuels frais de timbre et d'encaissement d'effets et de traites sont à la charge de l'acheteur. En cas de défaillance, même partielle, des intérêts de retard commencent à courir en faveur du Vendeur, à compter du jour fixé pour le paiement, dans la mesure prévue par le Décret législatif italien n° 231 du 09/10/2002. F.4.- Sauf accord écrit contraire, l'acheteur s'engage à ne compenser aucune créance échue.

G.- RÉCLAMATIONS

G.1.- À la réception des Produits, l'acheteur devra soumettre ces derniers à un contrôle minutieux

moyennant un examen visuel effectué conformément aux indications du point 7 des normes UNI EN ISO 10545-2.

G.2.- L'installation et la pose des Produits doivent être effectuées en suivant scrupuleusement les recommandations inhérentes aux activités exercées avant et durant la pose indiquées sur le document 1) Manuel de Pose, d'Utilisation, de Nettoyage et d'Entretien, publié sur le site Internet du Vendeur ainsi qu'à l'extérieur et/ou à l'intérieur de l'emballage du produit. Les défauts dus à une installation erronée et à un entretien absent / erroné (ne respectant pas les indications fournies dans le 1) Manuel de Pose, d'Utilisation, de Nettoyage et d'Entretien), par un usage prévu inapproprié et / ou par l'usure normale due au temps ne sont pas considérés comme des vices du Produit.

G.3.- Sous réserve des limites d'acceptabilité prévues par la norme internationale EN 14411 (ISO 13006), les Parties reconnaissent comme des Vices Évidents les défauts des Produits existant dès la réception de sorte que le matériel devienne inutilisable ou qu'il perde une grande partie de sa valeur. Cette catégorie comprend les défauts définis dans le document 1) Manuel de Pose, d'Utilisation, de Nettoyage et d'Entretien publié sur le site Internet du Vendeur. A titre d'exemple non contraignant, on reconnaît comme des Vices Évidents les défauts de surface, de décoration, de polissage, de calibre, de planéité, d'orthogonalité rectitude, d'épaisseur, les fissures, les ébréchés, les hors nuance, les nuances mélangées et les Produits qui présentent des problèmes de coupe -voile.

G.4.- Si l'acheteur relève des Vices Évidents, il devra présenter une réclamation écrite au Vendeur, sous peine de déchéance, dans un délai de 8 (huit) jours à compter de la réception et tenir le lot complet de matériel à la disposition de ce dernier. La réclamation devra indiquer les données de l'installation et une description précise du vice objet de la réclamation, accompagnée, si possible, de photographies. Si la réclamation devait s'avérer sans fondement, l'acheteur est disposé à rembourser au Vendeur les dépenses encourues pour l'éventuelle visite des lieux (expertises, déplacements, etc.). G.5.- Les Vices Cachés devront être notifiés au Vendeur par lettre recommandée avec avis de réception, sous peine d'annulation de la garantie, dans un délai de 8 (huit) jours à compter de la date de la découverte du défaut.

G.6.- L'action de l'acheteur ayant pour but de faire valoir la garantie en cas de vices se prescrit dans un délai de 12 (douze) mois à compter de la livraison des Produits.

H.- GARANTIE COUVRANT LES VICES

H.1.- La garantie du Vendeur est réputée limitée aux seuls Produits de premier choix et non aux Produits de second ou de troisième choix ou à des lots d'occasion auquel on applique des prix ou des remises particulières lorsqu'ils sont dûment signalés dans les notes de la Confirmation de Commande.

H.2.- Le Vendeur ne garantit pas l'adéquation des Produits à des usages particuliers, mais uniquement les caractéristiques techniques publiées sur le site Internet dans le document 2) Fiches techniques. L'usage indiqué, également lorsqu'il est présenté par le Vendeur dans des catalogues et des manuels, est purement indicatif. Sur la base des caractéristiques techniques indiquées dans les 2) Fiches Techniques, le concepteur a toujours le devoir d'évaluer l'adéquation du Produit aux conditions spécifiques d'utilisation en fonction des contraintes et des variables pouvant se vérifier dans le lieu de destination et susceptibles d'en altérer les caractéristiques, par exemple, l'intensité et la qualité de la circulation (piétinement en présence de sable, de détritux...), ainsi que les éventuelles conditions climatiques défavorables et toute autre incidence à laquelle peut être exposé le matériel.

H.3.- Si l'on a constaté que le Produit présente les Vices Évidents définis à la lettre G n°3, le Vendeur remplacera le Produit défectueux par un autre produit ayant des caractéristiques analogues ou supérieures ou, lorsque cela est impossible, à une réduction cohérente du prix. En alternative, l'acheteur aura droit, après la restitution des Produits défectueux, au remboursement du prix payé, majoré du prix du transport, à l'exclusion du remboursement de tout autre préjudice direct et / ou indirect. H.4.- La garantie du Vendeur doit être réputée exclue au cas où le Produit présentant des Vices Évidents (entièrement ou partiellement) aurait été utilisé et / ou du moins transformé ; dans ce cas, on considérera que l'acheteur (ou son client) a exprimé la volonté de les accepter en l'état.

H.5 Si l'on a constaté que le Produit présente des Vices Cachés, la garantie du Vendeur se limite au remplacement du matériel par du matériel ayant des caractéristiques analogues ou supérieures et, lorsque cela est impossible, au remboursement du prix payé majoré des frais de transport. En tout état de cause, la garantie du Vendeur couvrant tout dommage direct et / ou indirect causé par le produit défectueux, se limitera à une somme qui ne pourra pas dépasser le double du prix de vente appliqué par le Vendeur dans le cadre de la seule partie de la fourniture défectueuse.

H.6.- Si l'acheteur revend le Produit à des clients protégés par le code de la consommation (Décret-loi italien n° 206/2005) il sera responsable des conditions appliquées si celles-ci diffèrent des conditions indiquées ici et il devra s'assurer que les droits du consommateur sont exercés dans le respect des délais et des délais fixés par ce code. Si les conditions sont réunies, le droit de retrait et / ou de recours revenant à l'acheteur à l'encontre du Vendeur / fabricant ne pourra dépasser ni les exonérations ni les limites établies de la lettre G n°1 à la lettre H n°5..

I. CLAUSES SOLVE ET REPETE ET CLAUSES RÉSOLUTOIRES

I.1.- Aux termes de l'art. 1462 du Code Civil italien, en aucun cas, y compris les prétendus vices ou défauts du matériel, l'acheteur ne pourra suspendre ou retarder le paiement du matériel retiré, sans préjudice naturellement de la faculté d'exiger lorsqu'il est en mesure de démontrer avoir indûment payé.

I.2.- En cas de variation des conditions patrimoniales de l'acheteur ou de non-paiement même partiel de produits déjà fournis, le Vendeur se réserve la faculté de suspendre l'exécution des fournitures en cours et / ou de résilier les contrats sans que l'acheteur ne puisse revendiquer des indemnités directes et / ou indirectes d'aucune sorte.

L.- PACTE DE RÉSERVE DE PROPRIÉTÉ

L.1.- Tant que l'acheteur n'aura pas intégralement payé le prix, les Produits objet de la fourniture resteront la propriété du Vendeur.

L.2.- Au cours de la susdite période, l'acheteur assumera les obligations et les responsabilités de gardien, et il ne pourra ni aliéner, ni confier, ni permettre la saisie desdits Produits sans déclarer la propriété du Vendeur et informer immédiatement ce dernier par lettre recommandée avec avis de réception.

M.- FORCE MAJEURE

M.1.- Chacune des parties pourra suspendre l'accomplissement de ses obligations contractuelles lorsque cette exécution est rendue impossible ou objectivement trop onéreuse par un empêchement imprévisible indépendant de sa volonté comme : les grèves, les boycotts, les lock-outs, les incendies, les guerres (déclarées ou non), les guerres civiles, les révoltes et les révolutions, les réquisitions, les embargos, les coupures de courant, les ruptures exceptionnelles de machines, les retards de livraison de composants ou de matières premières. M.2.- La partie qui souhaite user de la présente clause devra communiquer immédiatement par écrit à l'autre partie la survenue et la cessation des circonstances de force majeure. M.3.- Si la suspension due à une force majeure dure plus de 60 (soixante) jours, chacune des parties aura le droit de résilier le présent contrat, avec un préavis de 10 (dix) jours, en le communiquant par écrit à la partie adverse.

N.- OBLIGATIONS DE CONFIDENTIALITÉ

N.1.- L'acheteur est tenu d'observer le secret le plus absolu concernant toutes les informations de caractère technique (comme, par exemple, les dessins, les notices, les documentations, les formules et la correspondance) et de caractère commercial (y compris les conditions contractuelles, les prix d'achat, les conditions de paiement, etc.) dont il aurait eu connaissance durant l'exécution du présent Contrat.

N.2.- L'obligation de confidentialité est assumée pendant toute la durée du Contrat, ainsi que pour la période successive à son exécution.

N.3.- Dans tous les cas de non-observation de l'obligation de confidentialité, la partie défaillante est tenue de réparer à l'autre partie tous les éventuels préjudices.

O.- MARQUES ET SIGNES DISTINCTIFS DU VENDEUR

O.1.- L'utilisation des marques, des modèles ornementaux et des oeuvres de l'esprit en général, sous quelque forme ou suivant quelque modalité d'expression que ce soit (à titre d'exemple, non contraignant : les images, les photos, les dessins, les vidéos, les figures, les structures, etc.) constituant la propriété intellectuelle du Vendeur, à travers tout moyen (à titre d'exemple non contraignant : l'impression, la vidéo, la radio, Internet, les médias sociaux, les plates-formes de messagerie instantanée ou VoIP, etc.) est formellement interdite. Toute dérogation à cette interdiction, même partielle, devra être autorisée par écrit, cas par cas, par la Direction générale du Vendeur.

P.- LANGUE DU CONTRAT, LOI APPLICABLE, JURIDICTION ET COMPÉTENCE

P.1.- Le Contrat et les présentes conditions sont rédigés en langue italienne qui prévaut en cas de divergence avec la traduction dans d'autres langues. P.2.- La définition de toute controverse relative aux fournitures est régie par la loi et la juridiction de l'État italien et les parties reconnaissent la compétence territoriale exclusive du Tribunal de Modène dans la circonscription duquel se trouve le siège légal du Vendeur.

ALLGEMEINE VERKAUFSBEDINGUNGEN / Fassung.1a - 01 Januar 2018

A. - MODALITÄT DES VERTRAGSABSCHLUSSES

A.1.- Die vorliegenden Allgemeinen Verkaufsbedingungen regeln alle Verträge zwischen dem Verkäufer und dem Käufer und alle Änderungen oder Abweichungen davon müssen schriftlich vereinbart werden.

A.2.- Eventuelle Angebote sowie mit Handelsvertretern oder sonstigen Vermittlern vereinbarten Gutschriften sind nicht verbindlich, es sei denn, sie werden vom Verkäufer schriftlich bestätigt.

A.3.- Der Käufer sendet dem Verkäufer direkt oder über Handelsvertreter schriftliche Bestellungen zu, die die Angabe der Artikelnummern der gewünschten Produkte, der Mengen, ihres Preises und der Bestimmung enthalten müssen. Die vom Käufer gesendete Bestellung ist unwiderruflich.

A.4.- Der Verkauf gilt zu dem Zeitpunkt als abgeschlossen, an dem: (i) der Käufer vom Verkäufer eine schriftliche Bestätigung per E-Mail, Fax oder auf sonstigem Weg erhält, die den Fristen und Bedingungen der Bestellung entspricht; oder (ii) falls die vom Verkäufer gesendete Bestätigung, Bedingungen enthält, die von der vom Käufer erhaltenen Bestellung abweichen, wenn dieser diese akzeptiert oder nicht innerhalb von 7 (sieben) Tagen ab ihrem Empfang beanstandet; oder (iii) falls keine schriftliche Bestätigung durch den Verkäufer erfolgt, zu dem Zeitpunkt, an dem die Produkte geliefert und vom Käufer übernommen werden.

B. - PREISE

B.1.- Vorbehaltlich abweichender schriftlicher Vereinbarungen gelten die von Mal zu Mal vereinbarten Verkaufspreise als Nettobarpreise bar mit Lieferung frei ab dem in der Auftragsbestätigung angegebenen Werk des Verkäufers.

C. - EIGENSCHAFTEN DER PRODUKTE

C.1.- Der Käufer erklärt, die folgende auf der Web-Site des Unternehmens veröffentlichte Dokumentation zur Kenntnis genommen zu haben und sich an deren Inhalt zu halten: 1) Handbuch zur Verlegung, Benutzung, Reinigung und Pflege, und 2) Technische Datenblätter.

C.2.- Aufgrund der intrinsischen Variabilität des Keramikprodukts sind die Eigenschaften der vorausgehend vom Verkäufer an den Käufer gesendeten Warenmuster und/oder Modelle hinweisend und unverbindlich.

C.3.- Vorbehaltlich spezifischer Vereinbarungen vor der Auftragsbestätigung garantiert der Verkäufer nicht, dass die Lieferung des einzelnen Artikels vollständig mit dem gleichen Produktionslos ausgeführt wird.

D. - LIEFERFRISTEN

D.1.- Die Lieferfristen sind unverbindlich und Verzögerungen führen für den Käufer in keinem Fall zum Anspruch auf Schadensvergütung.

D.2.- Falls der Käufer das Material nicht innerhalb von 10 (zehn) Tagen ab dem Datum der Bereitstellung der Waren abholt, behält sich der Verkäufer das Recht vor, eine neue Lieferfrist festzusetzen.

E. - RÜCKLIEFERUNG UND VERSAND

E.1.- Die eventuelle Änderung des Bestimmungsortes der Produkte, die sich von der in der Auftragsbestätigung vereinbarten unterscheidet, muss vom Käufer schriftlich innerhalb des zweiten Tags vor dem für die Abholung am Sitz des Verkäufers vorgesehenen mitgeteilt werden. Der Verkäufer behält sich das Recht vor, die Änderung der Bestimmung der Produkte nicht zu akzeptieren. Falls sich herausstellt, dass die effektive Bestimmung des Produkts von der vom Käufer angegebenen verschieden ist, behält sich der Verkäufer das Recht vor, die laufenden Lieferungen nicht auszuführen und/ oder die laufenden Verträge aufzulösen, ohne dass der Käufer jeglichen Anspruch auf Entschädigung geltend machen kann.

E.2.- Vorbehaltlich abweichender Vereinbarungen erfolgt die Lieferung der Ware frei ab Werk (EXW gemäß den Incoterms 2010), und dies auch, falls vereinbart wird, dass der Versand oder ein Teil desselben im Auftrag des Käufers durch den Verkäufer erfolgt. In jedem Fall gehen die Risiken spätestens mit der Übergabe an das erste Transportunternehmen an den Käufer über.

E.3.- Unter Beibehaltung der Nichtbeteiligung des Verkäufers am Transportvertrag kann der Verkäufer in der Police der Ladung als „Shipper“ angegeben werden. Die Mitteilung des Bruttogewichts des Containers an den Transportunternehmer stellt keine Übernahme der Verantwortung des Verkäufers hinsichtlich der SOLAS-Konvention dar (Safety Of Life At Sea). In keinem Fall kann diese Mitteilung als VGM (Verified Gross Mass) verstanden werden.

E.4.- Der Käufer verpflichtet sich sicherzustellen, dass das zu den Lagern des Verkäufers gesendete Fahrzeug unter Berücksichtigung der Natur der Produkte für das Laden geeignet ist. Falls das zum Laden gesendete Fahrzeug größere Probleme beim Beladen bereitet, behält der Verkäufer sich das Recht vor, zur Abdeckung der höheren Logistikkosten eine Vertragsstrafe in Höhe von 4 % des Werts der Produkte zu erheben. Falls das Fahrzeug vollkommen ungeeignet ist, behält sich der Verkäufer das Recht vor, das Verladen zu verweigern, ohne dass der Käufer einen Anspruch auf Vergütung der Schäden geltend machen kann, die direkt und/oder indirekt daraus entstehen können.

E.5.- Es ist Aufgabe des Käufers, das Transportunternehmen zu beauftragen und die Produkte vor dem Laden zu kontrollieren; eventuelle Anmerkungen zur Unversehrtheit der Verpackungen und der Übereinstimmung der geladenen Menge mit der in den Transportpapieren angegebenen müssen vom Transportunternehmen zum Zeitpunkt des Ladens vorgenommen werden. Diese Anmerkungen müssen auf alle Exemplare der Transportpapiere vermerkt werden, andernfalls gelten die geladenen Produkte als unbeschädigt und vollständig. Daraus folgt, dass der Verkäufer keinerlei Haftung für Fehlmengen oder Beschädigungen der Produkte übernimmt, die vom Transportunternehmen nicht gemeldet werden.

E.6.- Es ist ebenfalls Aufgabe des Käufers, das Transportunternehmen zu beauftragen und die Modalität und die Stabilität des Ladens auf das Fahrzeug zu überprüfen, damit es während des Transports nicht zu Brüchen kommt, sowie die Einhaltung der Sicherheitsbestimmungen der Straßenverkehrsordnung zu gewährleisten.

F. - ZAHLUNGEN

F.1.- Alle Zahlungsverpflichtungen müssen am Firmensitz des Verkäufers erfüllt werden. Eventuelle Zahlungen an Handelsvertreter oder Außendienstmitarbeiter gelten als nicht geleistet, bis sie beim Verkäufer eintreffen.

F.2.- Es ist dem Käufer untersagt, die Zahlungen aus Ländern vorzunehmen, die vom Land seines Firmensitzes verschieden sind, falls diese Länder keinen angemessenen Informationsaustausch mit Italien gewährleisten. Im Fall der Verletzung dieses Verbots hat der Verkäufer das Recht, den Vertrag aus gutem Grund aufzulösen, ohne dass der Käufer eine Vergütung des entstandenen Schadens geltend machen kann.

F.3.- Eventuelle Kosten und Gebühren für die Einziehung von Effekten und Wechseln gehen zu Lasten des Käufers. Im Fall der Nichteinhaltung des für die Zahlung festgesetzten Tags - auch nur partiell - fallen Säumniszinsen zu Gunsten des Verkäufers an, in der vom ital. Gesetzlerlass vom 9. Oktober 2002, Nr. 231 vorgesehenen Höhe.

F.4.- Vorbehaltlich abweichender schriftlicher Vereinbarungen verpflichtet sich der Käufer, keine Guthaben gegenüber dem Verkäufer zu verrechnen.

G. - BEANSTANDUNGEN

G.1.- Beim Empfang der Produkte muss der Käufer sie einer sorgfältigen Sichtkontrolle gemäß den Angaben von Punkt 7 der Normen UNI EN ISO 10545-2 unterziehen.

G.2.- Die Installation und die Verlegung der Produkte müssen unter Einhaltung der Empfehlungen zu den Arbeiten ausgeführt werden, die vor und während der Verlegung ausgeführt werden müssen, wie angegeben im Dokument 1) Handbuch zur Verlegung, Verwendung, Reinigung und Pflege, veröffentlicht auf der Web-Site des Verkäufers und angegeben auf der Verpackung des Produkts und/oder im Inneren derselben. Schäden, die durch eine falsche Installation, Verlegung und durch eine unterlassene/falsche Pflege (abweichend von den Angaben in 1) Handbuch zur Verlegung, Reinigung und Wartung), durch eine ungeeignete Gebrauchsbestimmung oder durch normale Abnutzung verursacht werden, werden nicht als Mängel des Produkts anerkannt.

G.3.- Vorbehaltlich der Grenzen der Akzeptabilität, die von der internationalen Norm EN 14411 (ISO 13006) vorgesehen sind, erkennen die Parteien Mängel der Produkte als offensichtliche Mängel an, die bereits bei ihrem Empfang festgestellt werden können, die das Material zur Verwendung ungeeignet machen oder die den Wert beträchtlich verringern. In diese Kategorie fallen Mängel, wie im Dokument definiert 1) Handbuch zur Verlegung, Benutzung, Reinigung und Pflege, veröffentlicht auf der Web-Site des Verkäufers. Als nicht erschöpfende Beispiele werden Oberflächenmängel, fehlerhafte Grafik, Defekte polierte Oberfläche, Defekte des Kalibers, der Planarität, der Rechtwinkligkeit/Gradlinigkeit, der Stärke, Risse, abgeschlagene Kanten, Fehlfarbe, gemischte Brandfarbe sowie Produkte mit Kantsplittierung durch Retifizierung als offensichtliche Mängel anerkannt.

G.4.- Falls der Käufer offensichtliche Mängel feststellt, muss er dies dem Verkäufer innerhalb von 8 (acht) Tagen ab dem Empfang schriftlich melden und die gesamte Charge des Materials für den Verkäufer zur Verfügung halten; anderenfalls verfällt der Rechtsanspruch. Bei der Beanstandung müssen die Daten der Rechnung sowie eine präzise Beschreibung des beanstandeten Mangels angegeben werden, falls möglich mit einer fotografischen Dokumentation. Falls die Beanstandung unberechtigt sein sollte, ist der Käufer gehalten, dem Verkäufer die für einen eventuellen Ortstermin aufgewendeten Kosten (Gutachten, Reisekosten, usw.) zu erstatten.

G.5.- Versteckte Mängel müssen dem Verkäufer innerhalb von 8 (acht) Tagen ab Feststellung des Mangels per Einschreiben mit Rückschein gemeldet werden; anderenfalls verfällt der Rechtsanspruch.

G.6.- Die Aktion des Käufers zur Inanspruchnahme der Mängelhaftung muss in jedem Fall innerhalb von 12 (zwölf) Monaten ab der Lieferung der Produkte erfolgen.

H. - MÄNGELHAFTUNG

H.1.- Die Garantie des Verkäufers ist begrenzt auf Produkte erster Qualität und sie bezieht sich nicht auf Produkte zweiter oder dritter Qualität oder auf gelegentliche Partien mit besonderen Preisen oder Nachlässe, die in der Auftragsbestätigung angegeben werden.

000H.2.- Der Verkäufer garantiert nicht die Eignung der Produkte für besondere Verwendungen, sondern lediglich die technischen Eigenschaften, die auf der Web-Site in Dokument 2) Technische Datenblätter veröffentlicht sind. Die Angabe zur Verwendung ist als unverbindlich anzusehen, auch wenn vom Verkäufer in Katalogen und Handbüchern angegeben ist. Es ist stets Aufgabe des Planers, auf der Grundlage der in den 2) Technischen Datenblättern angegebenen Eigenschaften die Eignung des Produkts für spezifische Nutzungsbedingungen zu bewerten, unter Berücksichtigung der Belastungen sowie der Variablen, die am Ort der Bestimmung auftreten und die Eigenschaften verändern können, wie zum Beispiel die Intensität des Verkehrs, die Qualität des Verkehrs (Begehung bei Vorhandensein von Sand, Schmutz usw.), die eventuellen klimatischen Bedingungen sowie alle sonstigen Einflüsse, denen das Material ausgesetzt sein kann.

000H.3.- Falls festgestellt wird, dass das Produkt offensichtliche Mängel aufweist, wie definiert in Punkt G, Nr. 3, nimmt der Verkäufer die Ersetzung des mangelhaften Produkts durch ein anderes mit gleichen oder höherwertigen Eigenschaften vor, oder er nimmt eine angemessene Reduzierung des Preises vor, falls dies nicht möglich ist. Alternativ hat der Käufer nach Rücklieferung der mangelhaften Produkte das Recht auf Rückerstattung des bezahlten Preises, zuzüglich der Transportkosten, mit Ausschließung der Vergütung aller direkten und/oder indirekten Schäden.

H.4.- Die Garantie des Verkäufers wird ausgeschlossen, falls das mangelhafte Produkt (ganz oder teilweise) verwendet und/oder umgewandelt worden ist, da davon ausgegangen wird, dass der Käufer (oder sein Kunde) dadurch seinen Willen zum Ausdruck gebracht hat, es in dem Zustand zu akzeptieren, in dem es sich befindet.

H.5.- Falls festgestellt wird, dass das Produkt versteckte Mängel aufweist, ist die Garantie des Verkäufers auf die Ersetzung des Materials durch anderes mit gleichen oder höherwertigen Eigenschaften beschränkt oder - falls dies nicht möglich ist - auf die Rückerstattung des bezahlten Preises, zuzüglich der Transportkosten. In jedem Fall ist die Garantie des Verkäufers für alle direkten und/oder indirekten Schäden, die durch das mangelhafte Produkt entstehen, auf einen Betrag begrenzt, der das Doppelte des Verkaufspreises nicht übersteigen kann, den der Verkäufer auf den mangelhaften Teil der Lieferung angewendet hat.

H.6.- Falls der Käufer das Produkt an Kunden weiterverkauft, die vom Verbraucherschutzgesetz (ital. Gesetzlerlass Nr. 206/2005) geschützt werden, ist er verantwortlich für die angewendeten Bedingungen, falls diese von den hier angegebenen abweichen, und er muss sicherstellen, dass die Rechte des Verbrauchers gemäß den Bestimmungen dieses Gesetzes ausgeübt werden können. Falls die Voraussetzungen gegeben sind, kann das Regressrecht des Käufers gegenüber dem Verkäufer/Hersteller nicht die Grenzen übersteigen, die von Punkt G, Nr. 1 bis Punkt H, Nr. 5 angegeben werden.

I. KLAUSEL SOLVE ET REPETE UND AUFLÖSUNGSKLAUSEL

I.1.- Gemäß den Bestimmungen von § 1462 des ital. Bürgerlichen Gesetzbuches kann der Käufer in keinem Fall - einschließlich von vermeintlichen Mängeln oder Defekten des Materials - die Zahlung des abgenommenen Materials aussetzen oder verzögern, natürlich vorbehaltlich des Rechts, ungerechtfertigt gezahlte Beträge zurückzufordern, und dies nur nach Erbringung des Nachweises der Rechtmäßigkeit der Forderung (Solve et Repete).

I.2.- Im Fall der Veränderung der Vermögensbedingungen des Käufers oder der auch nur partiellen Nichtbezahlung der bereits gelieferten Produkte kann der Verkäufer die laufenden Lieferungen aussetzen und/oder die laufenden Verträge auflösen, ohne dass der Käufer die Vergütung von direkten und/oder indirekten Schäden geltend machen kann.

L. - EIGENTUMSVORBEHALT

L.1.- Bis zur vollständigen Bezahlung des Preises durch den Käufer bleiben die Produkte, die den Gegenstand der Lieferung darstellen, Eigentum des Verkäufers.

L.2.- Während dieses Zeitraums übernimmt der Käufer die Pflichten und die Verantwortlichkeiten für die Aufbewahrung der gekauften Produkte und er kann sie nicht veräußern, zur Nutzung überlassen oder beschlagnahmen oder pfänden lassen, ohne das Eigentum des Verkäufers anzugeben und ohne diesen umgehend per Einschreiben mit Rückschein zu benachrichtigen.

M. - HÖHERE GEWALT

M.1.- Beide Parteien können die Ausführung der vertraglichen Pflichten aussetzen, wenn die Ausführung aus Gründen, die vom eigenen Willen unabhängig sind, unmöglich oder objektiv zu aufwendig wird, wie zum Beispiel: Streiks, Boykott, Aussperrung, Brand, Krieg (erklärt oder nicht), Bürgerkrieg, Aufstände und Revolutionen, Beschlagnahme, Embargo, Unterbrechungen der Energieversorgung, außerordentliche Defekte von Maschinen, Verspätung bei der Anlieferung von Komponenten und Rohstoffen.

000M.2.- Die Partei, die beabsichtigt, die vorliegende Klausel in Anspruch zu nehmen, muss der anderen Partei schriftlich das Auftreten von Umständen der Höheren Gewalt mitteilen.

000M.3.- Falls die Aussetzung aufgrund von Höherer Gewalt mehr als 60 (sechzig) Tage andauert, haben beiden Parteien das Recht, den vorliegenden Vertrag nach einer schriftlichen Vorankündigung von 10 (zehn) Tagen an die Gegenpartei aufzulösen.

N. - VERTRAULICHKEITSPFLICHT

N.1.- Der Käufer ist gehalten, über alle technischen Informationen (wie zum Beispiel Zeichnungen, Prospekte, Dokumentationen, Formeln und Schriftverkehr) und kommerziellen Informationen (einschließlich der Vertragsbedingungen, der Kaufpreise, der Zahlungsbedingungen usw.), in deren Kenntnis während der Ausführung des vorliegenden Vertrages kommt, absolute Vertraulichkeit einzuhalten.

N.2.- Die Vertraulichkeitspflicht wird für die Dauer des Vertrages sowie den Zeitraum nach seiner Ausführung übernommen.

N.3.- Im Fall der Nichteinhaltung der Vertraulichkeitspflicht ist die nicht einhaltende Partei gehalten, der anderen Partei alle daraus entstehenden Schäden zu vergüten.

O. - MARKEN UND KENNZEICHNUNGEN DES VERKÄUFERS

O.1.- Die Verwendung von Marken, Ziermotiven und geistigem Eigentum im Allgemeinen in jeder Form sowie jeder Ausdrucksform (als nicht erschöpfendes Beispiel: Bilder, Fotos, Zeichnungen, Filme, Abbildungen, Strukturen usw.), die intellektuelles Eigentum des Verkäufers sind, ist auf jede Weise (als nicht erschöpfendes Beispiel: Presse, Video, Radio, Internet, Social Media, Instant-Message-Plattform oder VoIP usw.) strengstens untersagt. Alle - auch nur partielle - Abweichungen von diesem Verbot müssen von Fall zu Fall schriftlich von der Generaldirektion des Verkäufers autorisiert werden.

P. - SPRACHE DES VERTRAGS, ANWENDBARES RECHT, RECHTSPRECHUNG UND GERICHTSSTAND

P.1.- Der Vertrag und die vorliegenden Bedingungen werden in italienischer Sprache verfasst, die im Fall der Abweichung der Übersetzung in andere Sprachen Vorrang hat.

P.2.- Die Regelung aller Rechtssachen hinsichtlich den Lieferungen unterliegt der Rechtsprechung des italienischen Staats und die territoriale Zuständigkeit liegt ausschließlich beim Bezirksgericht Modena, dem Ort des Firmensitzes des Verkäufers.

CONDICIONES GENERALES DE VENTA / Rev.1a de 1 de Enero 2018

A.- MODALIDADES DE CELEBRACIÓN DEL CONTRATO

A.1.- Las presentes Condiciones Generales de Venta disciplinan todo contrato de venta entre el Vendedor y el Comprador y toda modificación o cancelación debe ser establecida por escrito.
A.2.- Eventuales ofertas, acreditaciones y/o descuentos otorgados por agentes u otros intermediarios, no son considerados válidos mientras no sean confirmados por escrito por el Vendedor.
A.3.- El Comprador envía al Vendedor, directamente o a través de agentes, pedidos por escrito que deben contener la indicación de los códigos de los productos requeridos, de las cantidades, de sus precios y de su destino. El pedido enviado por el Comprador es irrevocable. A.4.- La venta deberá considerarse perfeccionada desde el momento en que: (a) el Comprador recibe por parte del Vendedor una confirmación -escrita a través de e-mail, fax u otros medios telemáticos- conforme con los términos y según las condiciones del pedido; o (b) en caso de confirmación enviada por el Vendedor que contenga condiciones diferentes de las del pedido enviado por el Comprador cuando este las acepte por escrito o, en todo caso, no las cuestione dentro de los 7 (siete) días sucesivos a la recepción; o (c) en ausencia de confirmación escrita por el Vendedor, en el momento en que los productos serán entregados y serán cargados por el Comprador.

B.- PRECIOS

B.1.- Salvo acuerdo escrito en contrario, los precios de venta acordados de manera puntual se entienden al tanto en efectivo y para entrega en el establecimiento del Vendedor indicado en la confirmación del pedido.

C.- CARACTERÍSTICAS DE LOS PRODUCTOS

C.1.- El Comprador declara haber visto y atenerse al contenido de la siguiente documentación publicada en el sitio internet de la empresa: 1) Manual de Colocación, Uso, Limpieza y Mantenimiento y 2) Fichas Técnicas.
C.2.- Dada la intrínseca variabilidad del producto cerámico, las características de las muestras y/o modelos enviados anteriormente por el Vendedor al Comprador deben ser considerados como aproximados y no vinculantes.
C.3.- Salvo especificaciones requeridas, a acordar antes de la confirmación del pedido, el Vendedor no garantiza que el pedido de un artículo en particular sea despachado como un mismo lote de producción.

D.- PLAZOS DE ENTREGA

D.1.- Los plazos de entrega deben entenderse como aproximados y su prórroga no puede devengar a favor del Comprador ningún derecho a solicitar indemnizaciones, sin excepciones posibles.
D.2.- Si, una vez transcurridos 10 (diez) días desde la fecha de aviso de estar lista la mercancía, el Comprador no retira el material, el Vendedor se reserva de establecer discrecionalmente un nuevo plazo de entrega.

E.- ENTREGA Y TRANSPORTE

E.1.- La eventual variación de lugar de destino de los productos, señalando un diferente respecto de aquel acordado en la confirmación de pedido, debe ser comunicada por el Comprador por escrito dentro del plazo máximo taxativo del penúltimo día previo al retiro desde el establecimiento del Vendedor. El Vendedor se reserva la facultad de no aceptar el cambio de lugar de destino de los Productos. En caso de verificarse que el destino efectivo del producto sea diferente de aquel declarado por el Comprador, el Vendedor se reserva la facultad de suspender la realización de los suministros en curso y/o de rescindir los contratos en curso sin que el Comprador pueda pedir resarcimientos directos y/o indirectos de ningún tipo.
E.2.- Salvo acuerdo en contrario, el suministro de la mercancía se entiende ex Works (EXW según Incoterms 2010) y ello también cuando se acuerde que el transporte o parte de él quede a cargo del Vendedor, según mandato del Comprador. En todo caso, los riesgos se transfieren al Comprador a más tardar con la entrega al primer transportador.

E.3.- Como confirmación del hecho de que el Vendedor es ajeno al contrato de transporte, el mismo no podrá ser indicado como "shipper" en la póliza de carga. La comunicación del peso bruto del contenedor al transportista no comporta ninguna asunción de responsabilidad de parte del Vendedor para los fines del Convenio SOLAS (Safety Of Life At Sea). De ninguna manera la antedicha comunicación podrá ser considerada como VGM (Verified Gross Mass).
E.4.- El Comprador se compromete a fin de que el vehículo enviado al establecimiento del Vendedor sea idóneo para cargar considerando la naturaleza de los productos. En caso de que el vehículo que se presenta comporte significativas dificultades para las operaciones de carga, el Vendedor se reserva el derecho a incluir una recarga del 4 % del valor de los productos a cobertura de los mayores costos logísticos. Si el vehículo enviado para retirar la mercancía no es absolutamente idóneo, el Vendedor se reserva la facultad de negar las operaciones de carga sin que nada pueda requerir el Comprador a título de resarcimiento por todo eventual costo directo y/o indirecto que de ello pueda derivar.

E.5.- Es tarea del Comprador encargar al transportista controlar los productos antes de cargarlos; eventuales observaciones sobre la integridad de los embalajes y la exactitud de las cantidades cargadas, así como aquellas puestas en el documento de transporte, deben ser presentadas por el transportista en el momento de cargar. Estas observaciones deben ser reproducidas en todas las copias de los documentos de transporte; de lo contrario los productos cargados se entienden íntegros y completos. De ello deriva que el Vendedor no se asume ninguna responsabilidad con referencia a faltas o daños en los productos no señalados por el transportista.
E.6.- Asimismo, es responsabilidad del Comprador encargar al transportista verificar las modalidades y la estabilidad de la carga sobre el vehículo a fin de que durante el transporte no se produzcan roturas y que sean respetadas todas las disposiciones sobre seguridad relativas a la circulación por vías públicas.

F.- PAGOS

F.1.- Toda obligación de pago debe ser cumplida en la sede legal del Vendedor. Eventuales pagos a agentes, representantes o auxiliares de comercio no se entienden efectuadas mientras las respectivas sumas no lleguen al poder del Vendedor.
F.2.- Queda prohibido para el Comprador cumplir su propia obligación mediante pagos provenientes de países que no sean su propio país de residencia si se trata de países que no garantizan adecuado intercambio de informaciones con Italia. En caso de violación de esta prohibición, el Vendedor tiene facultad de rescindir el contrato por justa causa sin que el Comprador pueda pretender derecho de obtener algún resarcimiento por eventual daño sufrido.
F.3.- Eventuales gastos de sello fiscal y de cobro de letras de cambio y efectos comerciales quedan a cargo del Comprador. En caso de incumplimiento, incluso solo parcial, del día fijado para el pago, se devengarán a favor del Vendedor los intereses de mora en la medida prevista por el Decreto Leg. n° 231 del 09/10/2002.

F.4.- Salvo acuerdos escritos que lo contradigan, el Comprador se compromete a no compensar ningún crédito de cualquier forma creado respecto del Vendedor.

G.- RECLAMOS

G.1.- Al recibir los productos, el Comprador deberá someterlos a cuidadoso control a través de un examen visual efectuado conforme según las indicaciones del punto 7.4 de las normas UNI EN ISO 10545-2.
G.2.- La instalación y colocación de los productos deberá efectuarse respetando escrupulosamente las recomendaciones inherentes a las actividades a realizar antes y durante la colocación, indicadas en el documento 1) Manual de Colocación, Uso, Limpieza y Mantenimiento publicado en el sitio internet del Vendedor y en el embalaje del producto y/o en el interior del mismo. No son considerados como vicios del producto aquellos generados por una errónea instalación y error/falta de mantenimiento (intervenciones diferentes de las instrucciones proporcionadas en el 1) Manual de Colocación, Uso, Limpieza y Mantenimiento), por un uso inapropiado y/o por el normal desgaste con el pasar del tiempo.
G.3.- Sin perjuicio de los límites de aceptabilidad previstos por la norma internacional EN 14411 (ISO 13006), las partes reconocen como vicios evidentes los defectos de los productos constatables ya en el momento de su recepción y tales que impidan el uso previsto del material o reduzcan de modo apreciable su valor. Forman parte de esta categoría los defectos precisamente establecidos en el documento 1) Manual de Colocación, Limpieza y Mantenimiento publicado en el sitio internet del Vendedor. A título solo de ejemplo, se reconocen como vicios evidentes los defectos superficiales, los defectos de decoración, de lepeado/pulido, de calibre, de planitud, de ortogonalidad-rectilínea, de espesor, las grietas, los astillados, las variaciones de tono, los tonos mezclados y los productos que presentan problemas de cortes/escamas.

G.4.- En caso de que el Comprador observe la presencia de vicios evidentes, deberá presentar reclamo al Vendedor por escrito, so pena de extinción del derecho, dentro de los 8 (ocho) días sucesivos a la recepción y mantener a disposición del Vendedor la partida completa de material. El reclamo deberá indicar los datos de facturación y una precisa descripción del vicio observado incluyendo, en lo posible, imágenes fotográficas. En caso de que el reclamo debiera demostrarse luego ser infundado, el Comprador se declara dispuesto a resarcir al Vendedor por los gastos efectuados para realizar la respectiva constatación in situ (peritajes, viajes, etc.).

G.5.- Los vicios ocultos deberán ser notificados al Vendedor mediante carta certificada con aviso de recibo, bajo pena de caducidad de la garantía, dentro de los 8 (ocho) días a contar de la fecha del descubrimiento del defecto.
G.6.- La acción del Comprador tendiente a hacer valer la garantía por vicios prescribe, en todo caso, en el plazo de 12 (doce) meses a contar de la entrega de los productos.

H.1.- La garantía del Vendedor se entiende limitada solo a los productos de primera selección y no a los productos de segunda o tercera selección o de partidas de ocasión con precios o descuentos especiales cuando ello se encuentra debidamente señalados en nota en la confirmación del pedido.
H.2.- El Vendedor no garantiza la idoneidad de los productos para usos particulares, sino solo las características técnicas publicadas en el sitio internet, documento 2) Fichas Técnicas. La indicación de uso, incluso cuando es presentada por el Vendedor en catálogos y manuales, debe considerarse solo como genérica. Sobre la base de las características técnicas señaladas en las 2) Fichas Técnicas, es siempre tarea del proyectista evaluar la idoneidad del producto en función de las condiciones específicas de uso en consideración de las solicitaciones y de las variables que pueden operar en el ambiente de destino, alterando sus características; a título de ejemplo: la intensidad del tráfico, la calidad del tráfico (tránsito en presencia de arena, de detritos, etc.), las eventuales condiciones climáticas adversas y cualquier otro factor aleatorio al que puede quedar expuesto el material.
H.3.- En caso de comprobarse que el producto manifieste vicios evidentes, tal como han sido definidos en la letra G n° 3, el Vendedor procederá a sustituir el producto defectuoso con otro con características iguales o superiores o, en el caso de que ello no sea posible, deberá efectuar una congrua reducción del precio. Como alternativa, el Comprador tendrá derecho, previa devolución de los productos viciados, al reembolso del precio pagado, agregándose el costo del transporte, con exclusión del resarcimiento de todo otro daño, directo y/o indirecto.
H.4.- La garantía del Vendedor debe considerarse excluida en caso de que el producto que presenta vicios evidentes (total o parcialmente) haya sido utilizado y/o, en cualquier caso, transformado, debiéndose estimar que de tal modo el Comprador (o su cliente) ha expresado la voluntad de aceptarlo en el estado en que se encuentra.
H.5.- En los casos en que quede comprobado que el producto presenta vicios ocultos, la garantía del Vendedor queda limitada a la sustitución del material con otro de características iguales o superiores y, allí donde ello no sea posible, al reembolso del precio pagado, agregándose el costo del transporte. En todo caso, la garantía del Vendedor por cada daño directo y/o indirecto de cualquier forma derivado de producto defectuoso, debe entenderse limitada a una suma que no podrá superar el doble del precio de venta aplicado por el Vendedor, con referencia solo a la parte defectuosa del suministro.
H.6.- En caso de que el Comprador revenda el producto a terceros protegidos por el código del consumo (D.L. n° 206/2005), será responsable de las condiciones practicadas si son diferentes de aquellas aquí señaladas y deberá comprobarse que los derechos del consumidor sean ejercidos con aplicación de los remedios y de los términos fijados por el antedicho código. En caso de subsistir las condiciones, el derecho de devolución y/o, en todo caso, de compensación a favor del Comprador respecto del Vendedor/productor, no podrán excederse las exenciones ni límites establecido en la letra G del n° 1 y en la letra H n° 5.

I. CLÁUSULAS SOLVE ET REPETE Y RESOLUTIVAS

I.1.- De conformidad con lo dispuesto por el art. 1462 del Código Civil, por ningún motivo, incluidos supuestos vicios o defectos del material, el Comprador podrá suspender o retardar el pago del material retirado, sin perjuicio obviamente de la facultad de restitución cuando pueda demostrar que ha pagado indebidamente.
I.2.- En el caso de cambiar las condiciones patrimoniales del Comprador o de falta de pago incluso parcial de productos ya suministrados, el Vendedor podrá suspender la realización de los suministros en curso y/o rescindir los contratos en curso sin que el Comprador pueda reivindicar resarcimientos directos ni indirectos de cualquier clase.

L. PACTO DE RESERVADO DOMINIO

L.1.- Mientras el Comprador no haya efectuado el pago integral del precio, los productos objeto del suministro seguirán siendo de propiedad del Vendedor.
L.2.- Durante el período antedicho, el Comprador asumirá las obligaciones y las responsabilidades del depositario y no podrá enajenar, entregar en uso ni dejar retener o embargar los productos sin declarar la propiedad del Vendedor y enviar inmediatamente aviso con carta certificada con aviso de recibo.

M. FUERZA MAYOR

M.1.- Cada parte podrá suspender la ejecución de sus obligaciones contractuales cuando esa ejecución se haga imposible u objetivamente demasiado onerosa por impedimento imprevisible independiente de su voluntad, tal como por ejemplo: huelga, boicot, bloqueo, incendio, guerra (declarada o no declarada), guerra civil, rebelión y revolución, requisición, embargo, interrupción de energía, rotura extraordinaria de maquinaria, retraso en la entrega de componentes o materias primas.
M.2.- La parte que desee valerse de la presente cláusula deberá comunicar de inmediato por escrito a la otra parte el verificarse y el cese de las circunstancias de fuerza mayor.
M.3.- En caso de que la suspensión causada por fuerza mayor dure más de 60 (sesenta) días, cada una de las partes tendrá derechos de rescindir el presente contrato, con preaviso de 10 (diez) días, a comunicar a la otra parte por escrito.

N. OBLIGACIÓN DE CONFIDENCIALIDAD

N.1.- El Comprador debe mantener la más absoluta confidencialidad respecto de todas las informaciones de carácter técnico (tales como, solo como ejemplo, diseños, prospectos, documentaciones, fórmulas y correspondencia) y de carácter comercial (incluidas las condiciones contractuales, los precios de compra, las condiciones de pago, etc.) obtenidas a propósito de la ejecución del presente contrato.
N.2.- La obligación de confidencialidad es válida por toda la duración del contrato, así como por el período sucesivo a su ejecución.
N.3.- En cualquier caso de inobservancia de la obligación de confidencialidad, la parte incumplidora deberá indemnizar a la otra por todos los daños que de ello puedan derivar.

O. MARCAS Y SIGNOS DISTINTIVOS DEL VENDEDOR

O.1.- Queda severamente prohibido el uso a través de cualquier medio (tales como, solo a título de ejemplos no exhaustivos: prensa, videos, radio, internet, social media, plataformas de mensajería instantánea o VoIP, etc.) de las marcas, de los modelos ornamentales y de las obras del ingenio en general que constituyan propiedad intelectual del Vendedor y ello en cualquier forma o modo de expresión (tales como, solo a título de ejemplos no exhaustivos: imágenes, fotos, dibujos, videos, figuras, estructuras, etc.). Cualquier excepción a esta prohibición, incluso solo parcial, deberá ser autorizada caso por caso por escrito por la dirección general del Vendedor.

P. IDIOMA DEL CONTRATO, LEY APPLICABLE, JURISDICCIÓN Y COMPETENCIA

P.1.- El contrato y las presentes condiciones son redactados en lengua italiana, la cual prevalecerá en caso de divergencia con las traducciones en otros idiomas.
P.2.- La resolución de cualquier controversia de cualquier forma relativa al suministro queda sujeta a la ley y a la jurisdicción del Estado Italiano y la competencia territorial es asignada de forma exclusiva al Tribunal de Módena, en cuya circunscripción el Vendedor tiene su domicilio legal.

IT_

Ceramiche Keope raccomanda l'utilizzo delle lastre in spessore 6 mm per le sole applicazioni in ambito residenziale, commerciale a traffico leggero e comunque in contesti ove non vi sia passaggio di carichi puntuali pesanti o transito di carrelli a ruote dure. Oltre all'utilizzo a rivestimento è inoltre possibile posarle su pavimenti preesistenti in marmo, pietra naturale o ceramica, senza la necessità di demolire la pavimentazione sottostante.

Per l'applicazione su massetto Ceramiche Keope consiglia l'utilizzo del gres porcellanato in spessore tradizionale.

Per una posa ad opera d'arte, consultare Consigli di posa, pulizia e manutenzione al link keope.com.

IT_

Ceramiche Keope si riserva la facoltà di apportare variazioni ai prodotti illustrati in questo catalogo per necessità produttive o al fine di migliorarne la qualità. I campioni e le immagini sono puramente indicativi. Gli imballaggi e pesi riportati possono variare per necessità produttive. Consultare gli uffici commerciali al momento dell'ordine.

FR_

Ceramiche Keope conseille de n'utiliser les plaques d'une épaisseur de 6 mm que pour des applications à caractère résidentiel ou commercial avec circulation modérée et, plus généralement, uniquement dans des situations qui ne prévoient pas le passage ponctuel de charges lourdes, ni le transit de chariots à roues dures. Outre leur utilisation pour le revêtement de parois, il est également possible de les poser sur des sols anciens en marbre, en pierres naturelles ou en carrelage, c'est-à-dire sans nécessité de démolir le revêtement de sol précédent.

Pour l'application sur une chape, Ceramiche Keope conseille d'utiliser un grès cérame de l'épaisseur habituelle.

Pour une pose selon les règles de l'art, veuillez consulter nos Conseils de pose, nettoyage et entretien disponibles sur le lien keope.com.

FR_

Ceramiche Keope se réserve la faculté d'apporter des variations aux produits illustrés dans ce catalogue dans un but inhérent à la production ou afin d'en améliorer la qualité. Les échantillons et les images sont purement indicatifs. Les emballages et les poids reportés peuvent varier pour des nécessités de production. Consulter les bureaux commerciaux au moment de la commande.

EN_

Ceramiche Keope recommends the use of 6 mm thick tiles only for residential and low traffic commercial applications. These tiles are not recommended for applications involving the transit of heavy loads or hard-wheeled trolleys. 6 mm thick tiles can be installed as wall coverings and as floor coverings over existing marble, stone or ceramic floors without having to demolish the previous floor.

Ceramiche Keope recommends the use of porcelain tiles of conventional thickness for applications over screed.

To ensure a perfect finish, consult the recommendations for laying, cleaning and maintenance available from keope.com.

EN_

Ceramiche Keope reserves the right to vary the products illustrated in this catalogue for production purposes or in order to improve quality. Samples and images are purely indicative. Packaging and weights shown may be varied in line with production requirements. Check with the sales department at the time of order.

DE_

Ceramiche Keope empfiehlt die Verlegung der 6-mm-starken Platten nur für den Wohn- und Gewerbebereich mit leichtem Verkehr. Das Produkt sollte nur in Umgebungen zur Anwendung kommen, in denen keine schweren Punktlasten entstehen und keine Wagen mit harten Rädern durchfahren. Neben der Verwendung als Wandbelag eignet sich das Material auch für die Verlegung auf bestehenden Marmor-, Naturstein- oder Keramikböden, ohne dass der darunter liegende Bodenbelag abgerissen werden muss.

Für die Anwendung auf Estrichen empfiehlt Ceramiche Keope die Verwendung von Feinsteinzeug mit traditioneller Stärke.

Für eine korrekte Verlegung sollten die Verlege-, Reinigungs- und Wartungsanweisungen unter keope.com beachtet werden.

DE_

Ceramiche Keope behält sich das Recht vor, Änderungen an den Produkten aus diesem Katalog aufgrund von Produktionsnotwendigkeiten vorzunehmen, oder um die Qualität zu verbessern. Die Muster und Bilder dienen allein zur Orientierung und sind nicht verbindlich. Die Verpackung und die angegebenen Gewichte können durch Produktionsanforderungen variieren. Wenden Sie sich bitte zur Bestellung an unsere Vertriebsabteilung.

ES_

Ceramiche Keope recomienda utilizar baldosas de 6 mm de espesor para uso en zonas residenciales, zonas comerciales con poco tráfico y zonas por las que no circulen cargas pesadas o carros de ruedas duras, ni siquiera de forma provisional. Además de utilizarse como revestimiento, pueden instalarse sobre suelos previamente existentes de mármol, piedra natural o cerámica sin la necesidad de quitarlos.

Para aplicaciones sobre solera, Ceramiche Keope recomienda utilizar el gres porcelánico de espesor normal.

Para una colocación perfecta, consulte los consejos de colocación, limpieza y mantenimiento en el enlace keope.com.

ES_

Ceramiche Keope se reserva la facultad de aportar variaciones a los productos ilustrados en este catálogo por necesidades de producción o con el fin de mejorar su calidad. Las muestras y son puramente indicativas. Los embalajes y las imágenes pesos indicados podrán variar por necesidades de producción. Consultar con los departamentos comerciales al realizar el pedido.