

WCE

CATÁLOGO

A MEDIDA | STOCK

SALA DE EXPOSICIÓN



Presentamos nuestra nueva sala de exposiciones, ubicada en el polígono industrial de Sant Esteve Sesrovires, Barcelona, en las instalaciones de Velvet.

Este espacio estará disponible para clientes y profesionales que deseen conocer nuestros productos y puedan tener contacto de forma presencial con los mismos.

Solicite una cita previa en info@mamparasvelvet.com

CATÁLOGO V.24

CATÁLOGO ONLINE V.24

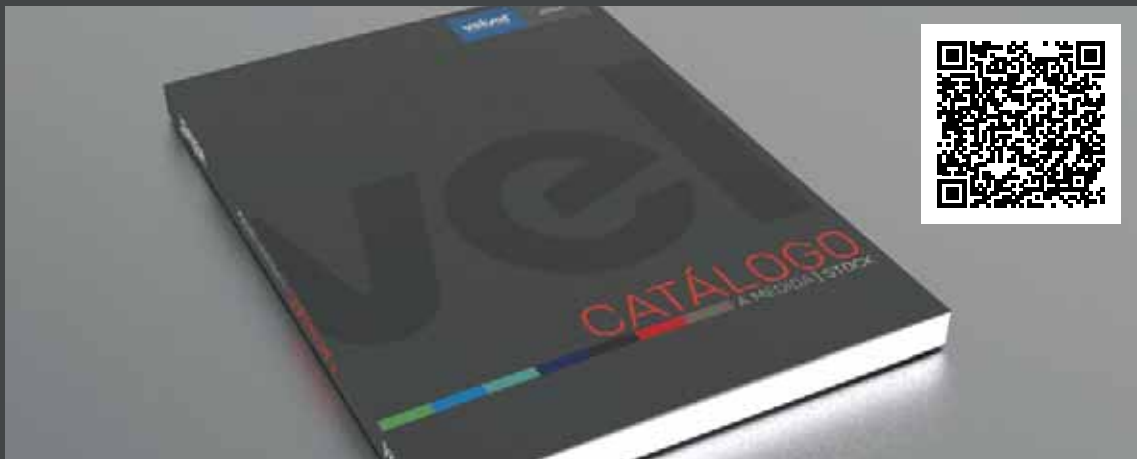

www.mamparasvelvet.com



velvet[®]

FABRICANTES DE MAMPARAS, DESDE 1981.

Velvet es una empresa fabricante de mamparas de ducha y bañera, con diseños exclusivos, soluciones creativas y personalizadas para todo tipo de baños y exigencias del cliente.

Con más de 40 años presente en el mercado nacional y con el objetivo de conseguir la máxima satisfacción por parte de nuestros clientes, seguimos ampliando y mejorando la cartera de productos para garantizar las demandas más exigentes.



CE



Los modelos fabricados por Velvet cumplen con las más exigentes normas de calidad y prestaciones. Todos los productos que llegan a la mano de nuestros clientes están certificados con el marcado CE y la normativa europea EN 14428.

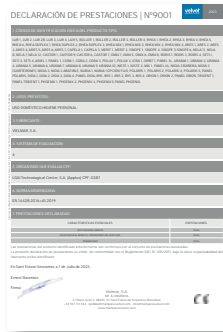

[DECLARACIÓN DE PRESTACIONES](#)

ÍNDICE

[CUADROS DE BÚSQUEDA RÁPIDA](#)

6

[PANELES FIJOS](#)

8



ENTREGA
INMEDIATA



FABRICACIÓN
A MEDIDA

[NIDIA 3](#)

10

[NIDIA 3 ABATIBLE](#)

11

[NIDIA 3 CUARTERONES](#)

12

[NIDIA 3 BAÑERA](#)

13

PANELES STOCK Y
A MEDIDA

[ABATIBLES BAÑERA](#)

14



ENTREGA
INMEDIATA



FABRICACIÓN
A MEDIDA

[NUBIA 1](#)

14

[NUBIA 1 FIJO](#)

15

[NIDIA 3 | ESPECIALES](#)

16

[CORREDERAS](#)

18



ENTREGA
INMEDIATA

[PHOENIX NOVEDAD](#)

20

[POLARIS](#)

26

[DIDA](#)

32

[ORION](#)

38

[TRIDENT](#)

42

CORREDERAS STOCK



FABRICACIÓN
A MEDIDA

[LUR](#)

46

[LUR | ESPECIALES](#)

54

[ROLLER](#)

56

[ROLLER | ESPECIALES](#)

62

[RHEA](#)

64

[RHEA DÚPLEX](#)

72

[ARES](#)

80

[ARES | ESPECIALES](#)

89

CORREDERAS MÍNIMA PERFILERÍA

[ORBIT](#)

120

[URANIA](#)

124

ACRÍLICAS OPCIÓN CRISTAL

ABATIBLES

90



CAPELA MERIT	94	ABATIBLES ABISAGRADAS
SINOPE NELA	96	
CASTOR OMIX	100	
ARIEL 1	108	
CORA	114	ABATIBLES PERFILERÍA LATERAL
POLUX	116	
URANIA 7	131	ACRÍLICAS OPCIÓN CRISTAL
URANIA 8	132	
URANIA ESPECIALES	135	

PLEGABLES

91



RHEA MIX	75	CORREDERAS MÍNIMA PERFILERÍA
RORIS SETI	104	ABATIBLES ABISAGRADAS
ABISAGRADAS ESPECIALES	110	
ICRA 1	118	ABATIBLES PERFILERÍA LATERAL
NISTE	136	ACRÍLICAS OPCIÓN CRISTAL
MIX 1	140	

PUERTAS DE PASO

142



VELA 1	144	PUERTAS DE PASO
VELA 2	145	
VELA 3	146	
VELA 4	147	
VELA 5	148	
VELA ESPECIALES	149	

[POMOS Y TIRADORES | ACCESORIOS Y OPCIONALES](#) 150

[RECAMBIOS | ACABADOS](#) 152

[SERIGRAFÍAS](#) 154

[TOMA DE MEDIDAS](#) 156

[HOJA PARA PEDIDOS](#) 157

[CONDICIONES GENERALES DE VENTA](#) 158

[NOTAS](#) 159

[CONTACTO](#) 161

Cuadros de búsqueda RÁPIDA*

CORREDERAS

FRONTALES

ANGULARES | CABINA

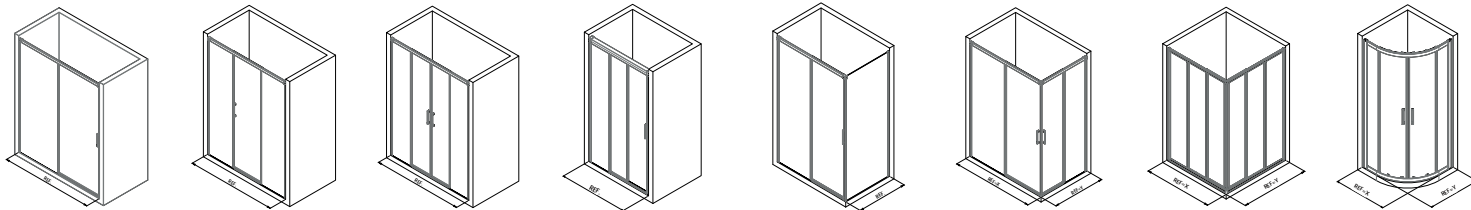

1 PUERTA + 1 FIJO	1 PUERTA + 2 FIJOS	2 PUERTAS + 2 FIJOS	2 PUERTAS + 1 FIJO + 3 PUERTAS	1 PUERTA CON 1 FIJO + PANEL LATERAL	2 PUERTAS + 2 FIJOS	2 FIJOS + 3 PUERTAS + 2 FIJOS + 2 Y 3 PUERTAS	2 PUERTAS + 2 FIJOS SEMICIRCULAR
PHOENIX 1 PVP: 335€ PÁGINA: 20	PHOENIX 5 PVP: 355€ PÁGINA: 24	PHOENIX 4 PVP: 445€ PÁGINA: 23	TRIDENT 1 PVP: 428€ PÁGINA: 44	PHOENIX 1 + PANEL PVP: 500€ PÁGINA: 20 + 25	PHOENIX 2 PVP: 452€ PÁGINA: 22	URANIA 10 PVP: 568€ PÁGINA: 134	DIDA 3 PVP: 496€ PÁGINA: 35
DIDA 1 PVP: 360€ PÁGINA: 32	POLARIS 5 PVP: 489€ PÁGINA: 30	DIDA 4 PVP: 505€ PÁGINA: 36	URANIA 4 PVP: 451€ PÁGINA: 128	DIDA 1 + PANEL PVP: 575€ PÁGINA: 32 + 37	URANIA 1 PVP: 476€ PÁGINA: 126	URANIA 9 PVP: 660€ PÁGINA: 133	URANIA 3 PVP: 611€ PÁGINA: 127
ORION 1 PVP: 401€ PÁGINA: 38	LUR 5 PVP: 781€ PÁGINA: 53	POLARIS 4 PVP: 522€ PÁGINA: 29	ORBIT 1 PVP: 497€ PÁGINA: 122	POLARIS 1 + PANEL PVP: 634€ PÁGINA: 26 + 31	DIDA 2 PVP: 484€ PÁGINA: 34		ARES 7 PVP: 1.594€ PÁGINA: 88
URANIA 5 PVP: 437€ PÁGINA: 129	RHEA 2 PVP: 979€ PÁGINA: 67	URANIA 6 PVP: 562€ PÁGINA: 130	RHEA DÚPLEX 2 PVP: 1.076€ PÁGINA: 73	ORION 1 + PANEL PVP: 659€ PÁGINA: 38 + 41	ORION 2 PVP: 536€ PÁGINA: 40		
POLARIS 1 PVP: 439€ PÁGINA: 26	ARES 2 PVP: 1.009€ PÁGINA: 83	LUR 4 PVP: 761€ PÁGINA: 52		URANIA 5 + PANEL 4L PVP: 663€ PÁGINA: 129 + 141	POLARIS 2 PVP: 594€ PÁGINA: 28		
LUR 1 PVP: 556€ PÁGINA: 48		RHEA 3 PVP: 1.057€ PÁGINA: 68		LUR 2 LUR 2B PVP: 781€ PÁGINA: 49 50	LUR 3 PVP: 792€ PÁGINA: 51		
RHEA 1 PVP: 792€ PÁGINA: 66		ARES 3 PVP: 1.124€ PÁGINA: 84		RHEA 4 RHEA 5 PVP: 1.057€ PÁGINA: 69 70	RHEA 6 PVP: 1.081€ PÁGINA: 71		
ARES 1 PVP: 849€ PÁGINA: 82		ROLLER 4 PVP: 1.292€ PÁGINA: 61		ARES 4 ARES 5 PVP: 1.181€ PÁGINA: 85 86	ARES 6 PVP: 1.227€ PÁGINA: 87		
ROLLER 1 PVP: 865€ PÁGINA: 58				ROLLER 2 PVP: 1.190€ PÁGINA: 59	ROLLER 3 PVP: 1.341€ PÁGINA: 60		

PLEGABLES

FRONTALES

ANGULARES | CABINA

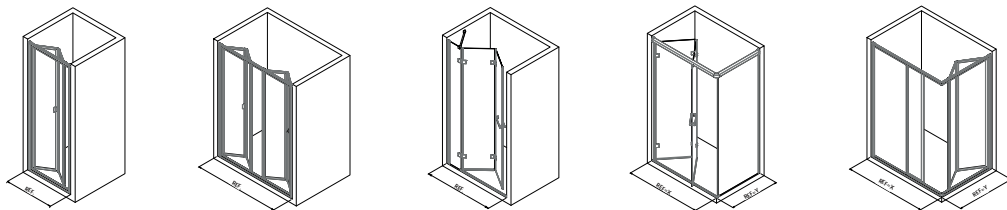

2 PUERTAS	4 PUERTAS	2 PUERTAS + 1 FIJO	2 PUERTAS + 1 FIJO	2 PUERTAS PLEGABLES + 1 PUERTA CORREDERA + 1 FIJO
NISTE 1 PVP: 463€ PÁGINA: 138	NISTE 2 PVP: 619€ PÁGINA: 139	RORIS 4 PVP: 644€ PÁGINA: 106	RHEA MIX 4 PVP: 1.057€ PÁGINA: 78	MIX 1 PVP: 642€ PÁGINA: 140
RORIS 1 PVP: 527€ PÁGINA: 104		RORIS 3 PVP: 674€ PÁGINA: 105	RHEA MIX 4B PVP: 1.057€ PÁGINA: 79	RHEA MIX 3 PVP: 1.286€ PÁGINA: 77
ICRA 1 PVP: 554€ PÁGINA: 118		SETI 4 PVP: 837€ PÁGINA: 106		
SETI 1 PVP: 685€ PÁGINA: 104		SETI 3 PVP: 876€ PÁGINA: 105		
RHEA MIX 1 PVP: 751€ PÁGINA: 75		RHEA MIX 2 PVP: 961€ PÁGINA: 76		

PANELES FIJOS

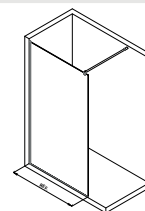

NIDIA 3 NIDIA 3 BAÑERA PVP: 257€ PÁGINA: 10 13
NIDIA 3 CUARTERONES PVP: 553€ PÁGINA: 12

ABATIBLES BAÑERA

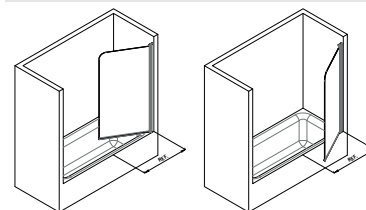

NUBIA 1 PVP: 215€ PÁGINA: 14





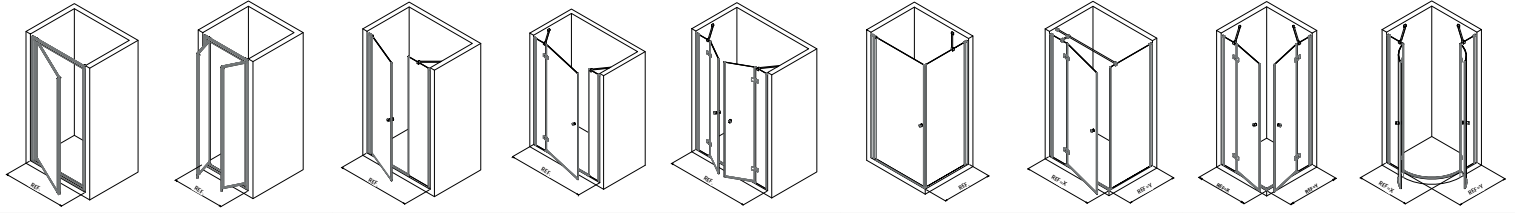

ABATIBLES

FRONTALES

ANGULARES | CABINA



1 PUERTA	2 PUERTAS	1 PUERTA + 1 FIJO	1 PUERTA + 2 PFIJOS	2 PUERTAS + 2 FIJOS	1 PUERTA + 1 PANEL	1 PUERTA Y 1 FIJO + 1 PANEL	2 PUERTAS 2 FIJOS	2 PUERTAS + 2 FIJOS SEMICIRCULAR
URANIA 7 PVP: 401€ PÁGINA: 131	URANIA 8 PVP: 426€ PÁGINA: 132	SINOPE 4 PVP: 540€ PÁGINA: 97	SINOPE 5 PVP: 745€ PÁGINA: 98	SINOPE 6 PVP: 958€ PÁGINA: 99	CORA 1 + CORA 2 PVP: 717€ PÁGINA: 114 + 119	CASTOR 9 PVP: 920€ PÁGINA: 103	CASTOR 1 PVP: 1000€ PÁGINA: 100	ARIEL 1 PVP: 1.382€ PÁGINA: 109
CAPELA 1 PVP: 422€ PÁGINA: 94	CAPELA 3 PVP: 548€ PÁGINA: 95	SINOPE 1 PVP: 550€ PÁGINA: 96	NELA 7 PVP: 968€ PÁGINA: 98	NELA 12 PVP: 1.245€ PÁGINA: 99	CASTOR 6 PVP: 765€ PÁGINA: 101	CASTOR 7 PVP: 920€ PÁGINA: 102	OMIX 7 PVP: 1.246€ PÁGINA: 100	
CORA 1 PVP: 444€ PÁGINA: 114	CORA 3 PVP: 549€ PÁGINA: 115	POLUX 1 PVP: 545€ PÁGINA: 116			OMIX 6 PVP: 938€ PÁGINA: 101	OMIX 5 PVP: 1.122€ PÁGINA: 103		
MERIT 1 PVP: 548€ PÁGINA: 94	MERIT 3 PVP: 712€ PÁGINA: 95	POLUX 3 PVP: 555€ PÁGINA: 117				OMIX 8 PVP: 1.122€ PÁGINA: 102		
		NELA 8 PVP: 705€ PÁGINA: 97						
		NELA 11 PVP: 715€ PÁGINA: 96						

-  CORREDERAS MÍNIMA PERFILERÍA**
-  ABATIBLES ABISAGRADAS**
-  ABATIBLES PERFILERÍA LATERAL**
-  ACRÍLICAS OPCIÓN CRISTAL**
-  PANELES STOCK Y A MEDIDA | ABATIBLES BAÑERA**
-  CORREDERAS STOCK

*Se muestra de menor a mayor precio las diferentes opciones pertenecientes a cada configuración de mampara disponible. Los precios son orientativos. Los modelos mencionados en los cuadros de búsqueda son en cristal transparente y acabado de serie.

**Serie apta para bañera. 

IVA no incluido. Montaje no incluido. Precios en €.

PANELES STOCK Y A MEDIDA

Serie de paneles fijos y puertas abatibles para ducha y bañera, de entrega inmediata o fabricación a medida. Vidrio templado de 8mm. Esta serie permite diferentes configuraciones para personalizar el cuarto de baño con elegancia y minimalismo.



ENTREGA
INMEDIATA
(STOCK)



FABRICACIÓN
A MEDIDA



Tensor incluido en el precio.



Opción enmarcada.



[SERIGRAFÍAS DISPONIBLES](#)
[PANELES A MEDIDA Y STOCK](#)

PANELES STOCK Y A MEDIDA



NIDIA 3. Negro.

NIDIA 3

Panel fijo para ducha. Vidrio templado de 8mm con tratamiento antical y tensor a pared.



FICHA TÉCNICA



INSTRUCCIONES DE MONTAJE

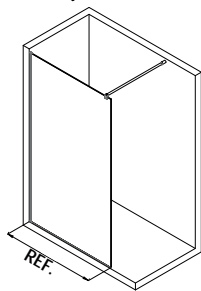
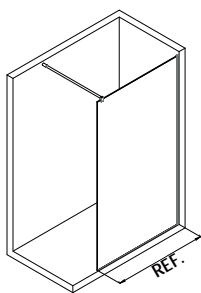

TENSOR INCLUIDO

NIDIA 3. Cromo brillo.

Para otras composiciones especiales de NIDIA 3, ver la página 16.

REF.	Medidas en cm.	PVP Cristal transparente	Fabricación
3051ESP	Hasta 77	257	
3048	De 78 a 79	257	
3049	De 88 a 89	276	
3050	De 98 a 99	294	
3051	De 108 a 109	310	
3052	De 118 a 119	329	
3052ESP	Hasta 140	410	

+50€
PVP
SERIGRAFÍA 1

+80€
PVP
SERIGRAFÍA 2



Cromo brillo



Negro +80€

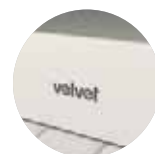

Blanco +80€



ENTREGA INMEDIATA



FABRICACIÓN A MEDIDA



VIDRIO TEMPLADO 8MM



VIDRIO TEMPLADO *OPCIONAL 10MM



TRATAMIENTO ANTICAL INCLUIDO



COMPENSACIÓN 1CM



ALTURA 195CM



TENSOR ARTICULADO +35€



TENSOR A TECHO +110€



OPCIÓN ENMARCADO +70€



APTO PARA ENCAJE +85€

Con serigrafía indicar lado de fijación. | Para mayor altura o anchura incremento de 30€ por cada 10cm: Altura hasta 240cm. | Altura superior a 240cm: consultar. Anchura superior a 140cm: consultar. | *OPCIONAL 10MM: Incremento de 30% sobre PVP Cristal transparente. Tensor incluido en el precio. | IVA no incluido. Montaje no incluido. Precios en €.

NIDIA 3 ABATIBLE

Puerta abatible opcional para el panel NIDIA 3. Apertura de 180° y fácil montaje.

PANELES EN STOCK Y A MEDIDA



FICHA
TÉCNICA



INSTRUCCIONES
DE MONTAJE

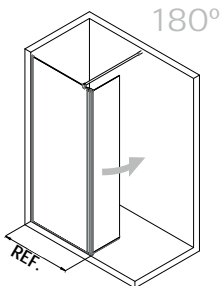
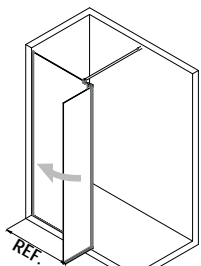

NIDIA 3 + ABATIBLE. Negro.

REF.	Medidas en cm.	PVP Cristal transparente	Fabricación
3055	25	116 + PVP NIDIA 3	
3056	40	138 + PVP NIDIA 3	
3055ESP	Hasta 40	185 + PVP NIDIA 3	
3056ESP	Hasta 60	245 + PVP NIDIA 3	

+20€
PVP

SERIGRAFÍA 1

+30€
PVP

SERIGRAFÍA 2

Cromo brillo

Negro +40€

Blanco +40€

ENTREGA
INMEDIATA

FABRICACIÓN
A MEDIDA

VIDRIO
TEMPLADO
6MM

TRATAMIENTO
ANTICAL
INCLUIDO

ALTURA
ESTÁNDAR
195CM

Indicar lado del fijo. | Para mayor anchura incremento de 30€ por cada 10cm. | Altura máxima 195cm.
IVA no incluido. Montaje no incluido. Precios en €.

NIDIA 3

CUARTERONES

Panel fijo para ducha de **fabricación a medida** con pintura vitrificada y diseño personalizable en diseño y color. Vidrio templado de 8mm y tensor a pared.



FICHA TÉCNICA



INSTRUCCIONES DE MONTAJE

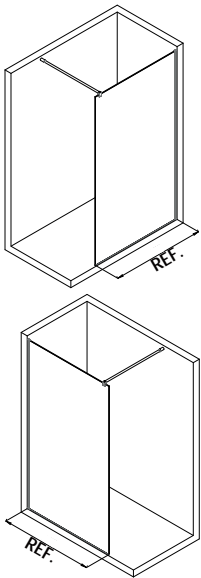

MODELO A



MODELO B



MODELO C



MODELO D

REF.	Medidas en cm.	PVP Cristal transparente	Fabricación
3058	Hasta 80	553	
3060	Hasta 100	667	
3062	Hasta 120	763	



TENSOR INCLUIDO



Cromo brillo



Negro



Blanco

PINTURA VITRIFICADA PERSONALIZABLE EN DISEÑO Y COLOR*

FABRICACIÓN A MEDIDA

VIDRIO TEMPLADO 8MM

VIDRIO TEMPLADO **OPCIONAL 10MM

TRATAMIENTO ANTICAL INCLUIDO

COMPENSACIÓN 1CM

ALTURA 195CM

ALTURA 150CM -15%€

TENSOR ARTICULADO +35€

TENSOR A TECHO +110€

OPCIÓN ENMARCADO +70€

Para mayor altura o anchura incremento de 45€ por cada 10cm: Altura hasta 240cm. | Altura superior a 240cm: consultar. | Anchura superior a 140cm: consultar. Tensor incluido en el precio. | *Personalización de las líneas rectas: grosor mínimo 1cm y separación mínima entre líneas 10cm. **OPCIONAL 10MM: Incremento de 30% sobre PVP Cristal transparente. | IVA no incluido. Montaje no incluido. Precios en €.

NIDIA 3 BAÑERA

Panel fijo para bañera de **fabricación a medida**. Vidrio templado de 8mm con tratamiento antical y tensor a pared.

PANELES EN STOCK Y A MEDIDA



FICHA TÉCNICA



INSTRUCCIONES DE MONTAJE

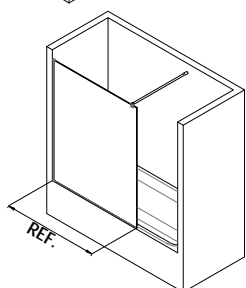
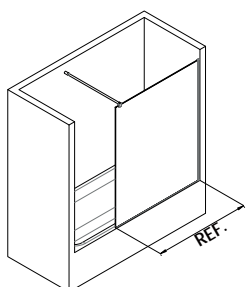

TENSOR INCLUIDO

NIDIA 3 BAÑERA. Cromo brillo.

REF.	Medidas en cm.	PVP Cristal transparente	Fabricación
3036	Hasta 80	257	
3037	Hasta 100	294	
3038	Hasta 120	329	

+50€
PVP

SERIGRAFÍA 1

+80€
PVP

SERIGRAFÍA 2



Cromo brillo



Negro +80€



Blanco +80€

FABRICACIÓN A MEDIDA

VIDRIO TEMPLADO 8MM

VIDRIO TEMPLADO *OPCIONAL 10MM

TRATAMIENTO ANTICAL INCLUIDO

COMPENSACIÓN 1CM

ALTURA 150CM

TENSOR ARTICULADO +35€

TENSOR A TECHO +110€

OPCIÓN ENMARCADO +70€

APTO PARA ENCAJE +85€

Con serigrafía indicar lado de fijación. | Para mayor anchura incremento de 30€ por cada 10cm. | Altura máxima 150cm. | Anchura máxima 140cm.

*OPCIONAL 10MM: Incremento de 30% sobre PVP Cristal transparente. | Tensor incluido en el precio. | IVA no incluido. Montaje no incluido. Precios en €.

NUBIA 1

Frontal abatible para bañera. Apertura de 180°.



FICHA
TÉCNICA



INSTRUCCIONES
DE MONTAJE

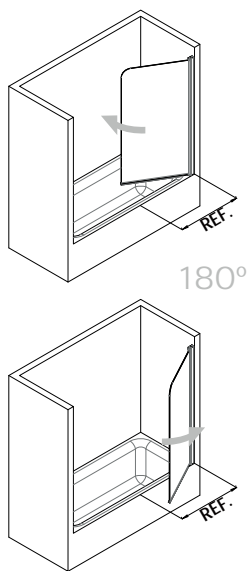

NUBIA 1. Cromo brillo. SERIGRAFÍA 1 D

REF.	Medidas en cm.	PVP Cristal transparente	Fabricación
1308	80	215	
1306ESP	Hasta 80	275	
1308ESP	Hasta 100	336	

+50€
PVP

SERIGRAFÍA 1

+80€
PVP

SERIGRAFÍA 2



Cromo brillo

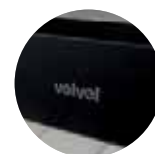

Negro +80€



Blanco +80€



ENTREGA
INMEDIATA



FABRICACIÓN
A MEDIDA



VIDRIO
TEMPLADO
6MM



TRATAMIENTO
ANTICAL
INCLUIDO



COMPENSACIÓN
1,5CM



ALTURA
150CM

Con serigrafía indicar lado de fijación. | Para mayor altura o anchura incremento de 30€ por cada 10cm. | Altura máxima 195cm.

IVA no incluido. Montaje no incluido. Precios en €.

NUBIA 1

FIJO

Panel fijo opcional para la frontal abatible NUBIA 1.



FICHA TÉCNICA



INSTRUCCIONES DE MONTAJE

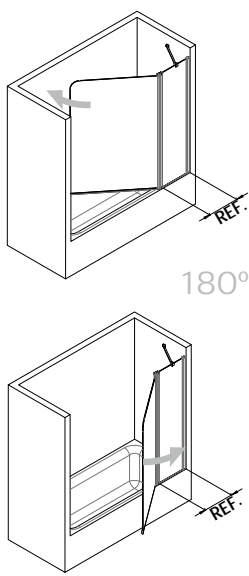

TENSOR INCLUIDO

NUBIA 1 + FIJO. Negro.

REF.	Medidas en cm.	PVP Cristal transparente	Fabricación
1315	25	120 + PVP NUBIA 1	
1314ESP	Hasta 25	168 + PVP NUBIA 1	
1315ESP	Hasta 40	205 + PVP NUBIA 1	

+20€
PVP

SERIGRAFÍA 1

+30€
PVP

SERIGRAFÍA 2



Cromo brillo



Negro +40€

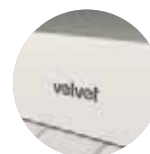

Blanco +40€



Indicar lado del fijo. | Para mayor altura o anchura incremento de 30€ por cada 10cm. | Altura máxima 195cm. | Tensor incluido en el precio.
IVA no incluido. Montaje no incluido. Precios en €.

NIDIA 3 | OTRAS COMPOSICIONES ESPECIALES*



A. NIDIA 3. Cromo brillo. CABINA ANGULAR.

*Consultar para cualquier composición especial.

PANELES STOCK Y A MEDIDA



B. NIDIA 3 ALTURA A TECHO. Negro.



C. NIDIA 3 BAÑERA. Negro. + OPCIÓN ENMARCADO + OPCIÓN TOALLERO.

*Consultar para cualquier composición especial.

CORREDERAS STOCK

Series de mamparas con puertas correderas para ducha de entrega inmediata o rápida expedición.

PHOENIX NOVEDAD 20

CORREDERAS STOCK



ENTREGA INMEDIATA



TRIDENT 42

CORREDERAS STOCK



ENTREGA INMEDIATA



POLARIS 26

CORREDERAS STOCK



RÁPIDA EXPEDICIÓN



DIDA 32

CORREDERAS STOCK



ENTREGA INMEDIATA



ORION 38

CORREDERAS STOCK



ENTREGA INMEDIATA



CORREDERAS A MEDIDA

Serie de mamparas con puertas correderas para ducha o bañera de fabricación a medida.

[LUR](#)

46

CORREDERAS MÍNIMA PERFILERÍA



FABRICACIÓN
A MEDIDA



[ARES](#)

80

CORREDERAS MÍNIMA PERFILERÍA



FABRICACIÓN
A MEDIDA



[ROLLER](#)

56

CORREDERAS MÍNIMA PERFILERÍA



FABRICACIÓN
A MEDIDA



[ORBIT](#)

120

ACRÍLICAS OPCIÓN CRISTAL



FABRICACIÓN
A MEDIDA



[RHEA](#)

64

CORREDERAS MÍNIMA PERFILERÍA



FABRICACIÓN
A MEDIDA



[URANIA](#)

124

ACRÍLICAS OPCIÓN CRISTAL



FABRICACIÓN
A MEDIDA



[RHEA DÚPLEX](#)

72

CORREDERAS MÍNIMA PERFILERÍA



FABRICACIÓN
A MEDIDA



Serie PHOENIX

Mamparas para ducha de entrega inmediata. Vidrio templado de 6mm y tratamiento antical de serie.

Perfilería minimalista, sin guía inferior, perfiles de compensación y fácil montaje.

PHOENIX 1

Frontal de ducha. Un fijo y una puerta corredera con aleta de cierre.



FICHA TÉCNICA



INSTRUCCIONES DE MONTAJE

REF.	Medidas en cm.	PVP Cristal transparente
500	de 100 a 105	335
501	de 105 a 110	343
502	de 110 a 115	351
503	de 115 a 120	359
504	de 120 a 125	367
505	de 125 a 130	375
506	de 130 a 135	383
507	de 135 a 140	391
508	de 140 a 145	399
509	de 145 a 150	407
510	de 150 a 155	415
511	de 155 a 160	423
512	de 160 a 165	431
513	de 165 a 170	439
514	de 170 a 175	447
515	de 175 a 180	455

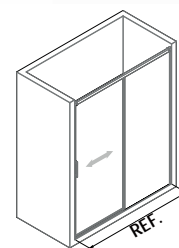
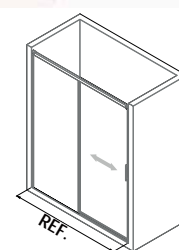

+50€
PVP

SERIGRAFÍA 1

+80€
PVP

SERIGRAFÍA 2



Plata brillo



Negro

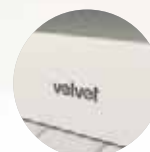

Blanco



ENTREGA INMEDIATA



VIDRIO TEMPLADO 6MM



TRATAMIENTO ANTICAL INCLUIDO



COMPENSACIÓN POR LADO 2,5CM



LIBERACIÓN DE PUERTA



SIN GUÍA INFERIOR



ALTURA ÚNICA 195CM



*MAMPARA REVERSIBLE

*Mampara reversible: Sólo para cristal transparente. | Con serigrafía indicar lado del fijo. | Indicar medida exacta del hueco. | IVA no incluido. Montaje no incluido. Precios en €.



Diseño minimalista.



Perfiles con compensación.



[SERIGRAFÍAS
DISPONIBLES
SERIE PHOENIX](#)



**3 ACABADOS
SIN INCREMENTOS**

CORREDERAS STOCK



PHOENIX 1. Negro.

PHOENIX 2

Angular de ducha. Dos fijos y dos puertas correderas con cierre magnético en el vértice.

REF.	Medidas en cm. por lado	PVP* Cristal transparente
520	De 66 a 68,5	226
521	De 68,5 a 71	229
522	De 71 a 73,5	232
523	De 73,5 a 76	235
524	De 76 a 78,5	238
525	De 78,5 a 81	241
526	De 81 a 83,5	244
527	De 83,5 a 86	247
528	De 86 a 88,5	250
529	De 88,5 a 91	253
530	De 91 a 93,5	256
531	De 93,5 a 96	259
532	De 96 a 98,5	262
533	De 98,5 a 101	265
534	De 101 a 103,5	268
535	De 103,5 a 106	271
536	De 106 a 108,5	274
537	De 108,5 a 111	277
538	De 111 a 113,5	280
539	De 113,5 a 116	283
540	De 116 a 118,5	286
541	De 118,5 a 121	289
542	De 121 a 123,5	292
543	De 123,5 a 126	295
544	De 126 a 128,5	298
545	De 128,5 a 131	301
546	De 131 a 133,5	304
547	De 133,5 a 136	307
548	De 136 a 138,5	310
549	De 138,5 a 141	313
549ESP	Hasta 150	328



PHOENIX 2. Plata brillo.



FICHA
TÉCNICA



INSTRUCCIONES
DE MONTAJE

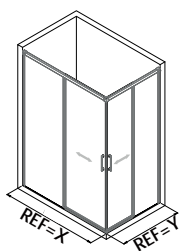

SERIGRAFÍA 1
TOTAL 2 LADOS



SERIGRAFÍA 2
TOTAL 2 LADOS

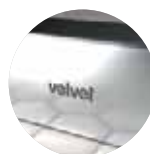

Plata brillo



Negro

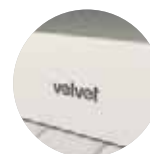

Blanco



ENTREGA
INMEDIATA



VIDRIO
TEMPLADO
6MM



TRATAMIENTO
ANTICAL
INCLUIDO



CIERRE
MAGNÉTICO



LIBERACIÓN
DE PUERTA



COMPENSACIÓN
POR LADO
2,5CM



SIN GUÍA
INFERIOR



ALTURA
ÚNICA
195CM

*Precio por lado. | Precio total: sumar ambos lados X+Y. | Indicar lado izquierdo/derecho. | Indicar medida y tipo de plato (Elevado o a ras de suelo).

IVA no incluido. Montaje no incluido. Precios en €.

PHOENIX 4

Frontal de ducha. Dos fijos y dos puertas correderas con cierre magnético en el centro.

REF.	Medidas en cm.	PVP Cristal transparente
560	De 150 a 155	445
561	De 155 a 160	453
562	De 160 a 165	461
563	De 165 a 170	469
564	De 170 a 175	477
565	De 175 a 180	485
566	De 180 a 185	493
567	De 185 a 190	501
568	De 190 a 195	509
569	De 195 a 200	517
569ESP	Hasta 220	549

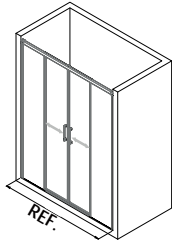

CORREDERAS STOCK

PHOENIX 4. Plata brillo.



FICHA
TÉCNICA



INSTRUCCIONES
DE MONTAJE



SERIGRAFÍA 1



SERIGRAFÍA 2



Plata brillo

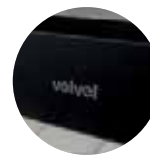

Negro

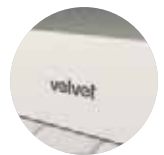

Blanco



ENTREGA
INMEDIATA



VIDRIO
TEMPLADO
6MM



TRATAMIENTO
ANTICAL
INCLUIDO



CIERRE
MAGNÉTICO



LIBERACIÓN
DE PUERTA



COMPENSACIÓN
POR LADO
2,5CM



SIN GUÍA
INFERIOR



ALTURA
ÚNICA
195CM

Indicar medida exacta del hueco. | IVA no incluido. Montaje no incluido. Precios en €.

PHOENIX 5

REF.	Medidas en cm.	Fijo de cierre por defecto*	PVP Cristal transparente
570	De 125 a 130	32cm	355
571	De 130 a 135	32cm	363
572	De 135 a 140	32cm	371
573	De 140 a 145	32cm	379
574	De 145 a 150	32cm	387
575	De 150 a 155	32cm	395
576	De 155 a 160	32cm	403
577	De 160 a 165	32cm	411
578	De 165 a 170	42cm	419
579	De 170 a 175	42cm	427
580	De 175 a 180	42cm	435
581	De 180 a 185	52cm	443
582	De 185 a 190	52cm	451
583	De 190 a 195	52cm	459
584	De 195 a 200	52cm	467
584ESP	Hasta 220	52cm	499

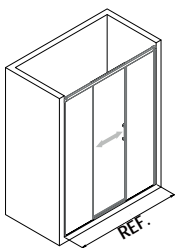
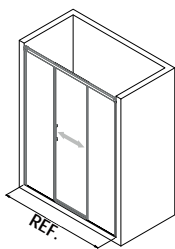

Frontal de ducha. Dos fijos y una puerta corredera central. Cierre al fijo.

PHOENIX 5. Negro.



FICHA TÉCNICA



INSTRUCCIONES DE MONTAJE



SERIGRAFÍA 1



SERIGRAFÍA 2

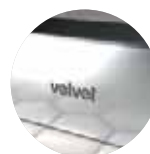

Plata brillo



Negro

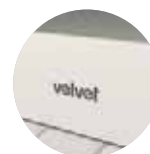

Blanco



ENTREGA INMEDIATA



VIDRIO TEMPLADO 6MM



TRATAMIENTO ANTICAL INCLUIDO



LIBERACIÓN DE PUERTA



COMPENSACIÓN POR LADO 2,5CM



SIN GUÍA INFERIOR



ALTURA ÚNICA 195CM

*Se puede combinar con fijos de 32cm, 42cm, 52cm, 63cm, 73cm y 84cm. | Indicar medida exacta del hueco. | Indicar lado de fijo de cierre. IVA no incluido. Montaje no incluido. Precios en €.

PANEL PHOENIX

Panel fijo lateral para formar cabina con los modelos PHOENIX 1, 2, 4 y 5.

REF.	Medidas en cm.	PVP Cristal transparente	Fabricación
590	Hasta 60	165	
591	Hasta 80	185	
592	Hasta 100	205	

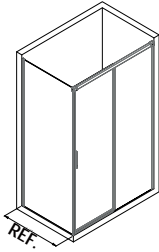
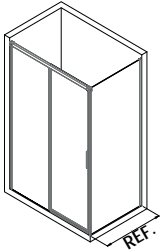

ALGUNAS OPCIONES



2 PANELES + PHOENIX 1. Plata brillo.



PANEL + PHOENIX 2. Negro.



PANEL + PHOENIX 4. Blanco.



PANEL + PHOENIX 5. Plata brillo.



PANEL + PHOENIX 1. Blanco.

CORREDERAS STOCK



[FICHA TÉCNICA](#)



[INSTRUCCIONES DE MONTAJE](#)



SERIGRAFÍA 1



SERIGRAFÍA 2



Plata brillo



Negro



Blanco



FABRICACIÓN A MEDIDA



VIDRIO TEMPLADO 6MM



TRATAMIENTO ANTICAL INCLUIDO



COMPENSACIÓN POR LADO 2,5CM



SIN GUÍA INFERIOR



REGULACIÓN - COMPENSACIÓN



ALTURA ÚNICA 195CM

Indicar medida y tipo de plato instalado (Elevado o a ras de suelo). | Indicar lado derecho/izquierdo.

IVA no incluido. Montaje no incluido. Precios en €.

Serie POLARIS

Mamparas para ducha de rápida expedición. Vidrio templado de 6mm con tratamiento antical de serie. Perfilaría minimalista. Sin guía inferior.

POLARIS 1

Frontal de ducha. Un fijo y una puerta corredera.

REF.	Medidas en cm.	PVP Cristal transparente
2610	Hasta 120	439
2611	Hasta 150	485
2612	Hasta 180	536



FICHA
TÉCNICA



INSTRUCCIONES
DE MONTAJE

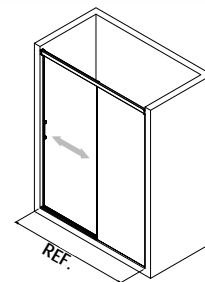
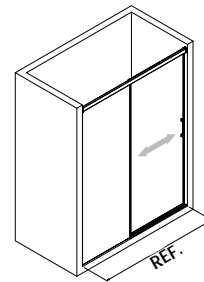

+50€
PVP

SERIGRAFÍA 1

+80€
PVP

SERIGRAFÍA 2

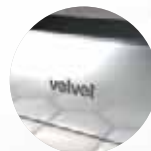

Plata brillo



Negro

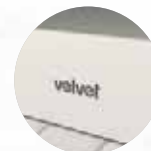

Blanco



RÁPIDA
EXPEDICIÓN



VIDRIO
TEMPLADO
6MM



TRATAMIENTO
ANTICAL
INCLUIDO



CIERRE
MAGNÉTICO
OPCIONAL
+30€



LIBERACIÓN
DE PUERTA



SIN GUÍA
INFERIOR



ALTURA
ÚNICA
195CM

Indicar lado del fijo. | Indicar medida exacta del hueco. | Medida mínima 100cm.

IVA no incluido. Montaje no incluido. Precios en €.

FABRICANTES DE MAMPARAS, DESDE 1981.



Acabados de alta calidad.



Desbloqueo de puerta



SERIGRAFÍAS
DISPONIBLES
SERIE POLARIS



3 ACABADOS
SIN INCREMENTOS

CORREDERAS STOCK



POLARIS 1. Plata brillo.

POLARIS 2

REF.	Medidas en cm. X+Y	PVP Cristal transparente
2620	Hasta 180	594
2621	Hasta 210	620
2622	Hasta 240	652

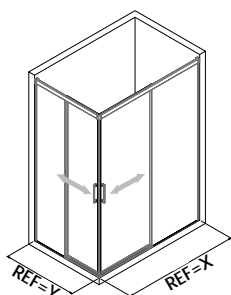
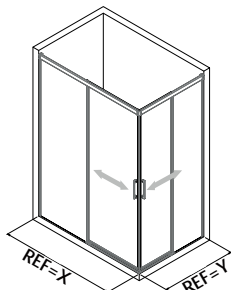

Angular de ducha. Dos fijos y dos puertas correderas con cierre magnético en el vértice.



POLARIS 2. Plata brillo. SERIGRAFÍA 1 H



[FICHA TÉCNICA](#)



[INSTRUCCIONES DE MONTAJE](#)

+70€
PVP

SERIGRAFÍA 1

+100€
PVP

SERIGRAFÍA 2

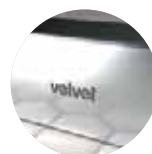

Plata brillo



Negro



Blanco



RÁPIDA
EXPEDICIÓN



VIDRIO
TEMPLADO
6MM



TRATAMIENTO
ANTICAL
INCLUIDO



CIERRE
MAGNÉTICO



LIBERACIÓN
DE PUERTA



SIN GUÍA
INFERIOR



ALTURA
ÚNICA
195CM

Indicar lado derecho/izquierdo. | Indicar medida y tipo de plato instalado (Elevado o a ras de suelo). | Medida mínima por lado 66cm. | Medida máxima por lado 150cm. IVA no incluido. Montaje no incluido. Precios en €.

POLARIS 4

REF.	Medidas en cm.	PVP Cristal transparente
2640	Hasta 130	522
2641	Hasta 160	553
2642	Hasta 190	584
2643	Hasta 220	616

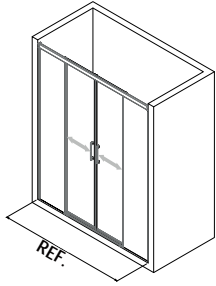

Frontal de ducha. Dos fijos y dos puertas correderas con cierre magnético en el centro.



CORREDERAS STOCK

POLARIS 4. Negro.



FICHA
TÉCNICA



INSTRUCCIONES
DE MONTAJE



SERIGRAFÍA 1



SERIGRAFÍA 2



Plata brillo

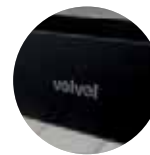

Negro



Blanco



RÁPIDA
EXPEDICIÓN



VIDRIO
TEMPLADO
6MM



TRATAMIENTO
ANTICAL
INCLUIDO



CIERRE
MAGNÉTICO



LIBERACIÓN
DE PUERTA



SIN GUÍA
INFERIOR



ALTURA
ÚNICA
195CM

Indicar medida exacta del hueco. | IVA no incluido. Montaje no incluido. Precios en €.

POLARIS 5

Frontal de ducha. Dos fijos y una puerta corredera central. Cierre al fijo.

REF.	Medidas en cm.	Fijo de cierre por defecto*	PVP Cristal transparente
2644	Hasta 150	32cm	489
2645	Hasta 180	42cm	541
2646	Hasta 220	52cm	583

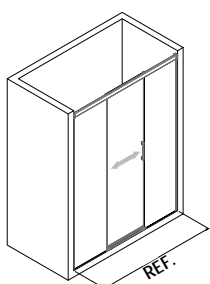
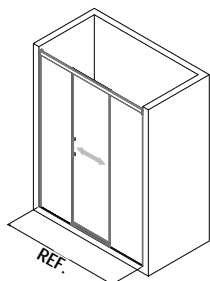

POLARIS 5. Negro.



[FICHA TÉCNICA](#)



[INSTRUCCIONES DE MONTAJE](#)



SERIGRAFÍA 1



SERIGRAFÍA 2

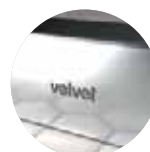

Plata brillo



Negro

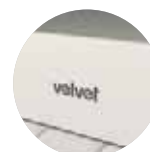

Blanco



RÁPIDA EXPEDICIÓN



VIDRIO TEMPLADO 6MM



TRATAMIENTO ANTICAL INCLUIDO



LIBERACIÓN DE PUERTA



SIN GUÍA INFERIOR





ALTURA ÚNICA 195CM

*Se puede combinar con fijos de 32cm, 42cm, 52cm, 63cm, 73cm y 84cm. | Indicar medida exacta del hueco. | Indicar lado de fijo de cierre. IVA no incluido. Montaje no incluido. Precios en €.

PANEL POLARIS

Panel fijo lateral para formar cabina con POLARIS 1.

REF.	Medidas en cm.	PVP Cristal transparente	Fabricación
2630	Hasta 60	195	
2631	Hasta 80	217	
2632	Hasta 100	240	

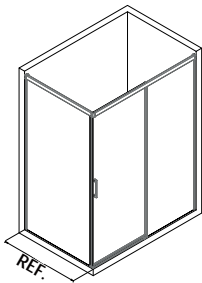
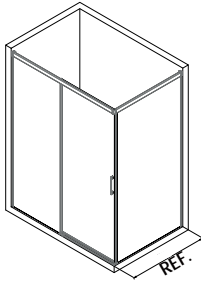

POLARIS 1 + PANEL POLARIS. Blanco

CORREDERAS STOCK



FICHA TÉCNICA



INSTRUCCIONES DE MONTAJE



SERIGRAFÍA 1



SERIGRAFÍA 2



Plata brillo



Negro

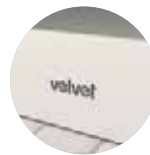

Blanco



FABRICACIÓN A MEDIDA



VIDRIO TEMPLADO 6MM



TRATAMIENTO ANTICAL INCLUIDO



CIERRE MAGNÉTICO



LIBERACIÓN DE PUERTA



SIN GUÍA INFERIOR



ALTURA ÚNICA 195CM

Indicar lado derecho/izquierdo. | Indicar medida y tipo de plato instalado (Elevado o a ras de suelo). | IVA no incluido. Montaje no incluido. Precios en €.

Serie DIDA

Mamparas para ducha de entrega inmediata. Vidrio templado de 6mm con tratamiento antical de serie. Con guía inferior y perfilería lateral con compensación.

DIDA 1

Frontal de ducha. Un fijo y una puerta corredera con cierre magnético.



FICHA
TÉCNICA

REF.	Medidas en cm.	Acceso en cm.	PVP Cristal transparente	Fabricación
700	De 102 a 108	41	360	
701	De 108 a 114	44	376	
702	De 114 a 120	47	389	
703	De 120 a 126	50	402	
704	De 126 a 132	53	413	
705	De 132 a 138	56	427	
706	De 138 a 144	59	442	
707	De 144 a 150	62	454	
708	De 150 a 156	65	466	
709	De 156 a 162	68	480	
709ESP*	Hasta 188		578	



INSTRUCCIONES
DE MONTAJE

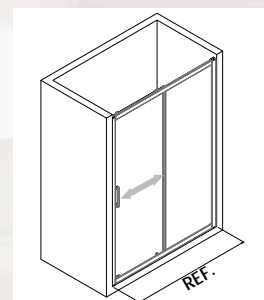
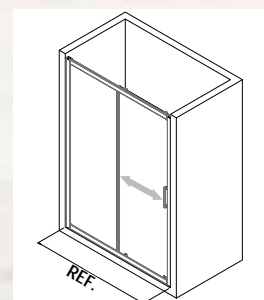

+50€
PVP

SERIGRAFÍA 1

+80€
PVP

SERIGRAFÍA 2

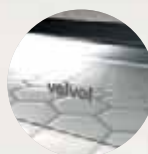

Cromo brillo



ENTREGA
INMEDIATA



FABRICACIÓN
A MEDIDA



VIDRIO
TEMPLADO
6MM



TRATAMIENTO
ANTICAL
INCLUIDO



CIERRE
MAGNÉTICO



LIBERACIÓN
DE PUERTA



COMPENSACIÓN
POR LADO
3CM



CON GUÍA
INFERIOR



ALTURA
195CM



**MAMPARA
REVERSIBLE

Con serigrafía, indicar lado del fijo. | Indicar medida exacta del hueco. | Altura máxima 195cm. | Anchura máxima 210cm.

**Mampara reversible. Sólo para cristal transparente.*Para mayor anchura incremento de 20€ por cada 10cm. | IVA no incluido. Montaje no incluido. Precios en €.



Perfilería con compensación.



Rodamientos de doble rueda.



SERIGRAFÍAS
DISPONIBLES
SERIE DIDA



DIDA 1. Cromo brillo.

DIDA 2

Angular de ducha. Dos fijos y dos puertas correderas con cierre magnético en el vértice.

REF.	Medidas en cm. por lado	PVP* Cristal transparente	Fabricación
710	De 67 a 70	242	
711	De 72 a 75	246	
712	De 77 a 80	250	
713	De 87 a 90	263	
714	De 97 a 100	272	
714L	De 107 a 110	283	
715	De 117 a 120	294	
716	De 137 a 140	327	
716ESP**	Hasta 145	363	

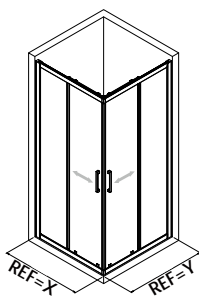

DIDA 2. Cromo brillo.

Acceso aproximado en las composiciones

70x90= 42cm	75x90= 43cm	80x80= 42cm	80x100= 49cm
70x100= 46cm	75x100= 47cm	80x90= 45cm	80x120= 57cm
70x120= 55cm	75x120= 56cm	90x90= 48cm	80x140= 66cm



FICHA
TÉCNICA



INSTRUCCIONES
DE MONTAJE

+70€
PVP

SERIGRAFÍA 1
TOTAL 2 LADOS

+100€
PVP

SERIGRAFÍA 2
TOTAL 2 LADOS



Cromo brillo



ENTREGA
INMEDIATA



FABRICACIÓN
A MEDIDA



VIDRIO
TEMPLADO
6MM



TRATAMIENTO
ANTICAL
INCLUIDO



CIERRE
MAGNÉTICO



LIBERACIÓN
DE PUERTA



COMPENSACIÓN
POR LADO
3CM



CON GUÍA
INFERIOR



ALTURA
195CM

*Precio por lado. | Precio total: sumar ambos lados X+Y. | Indicar lado izquierdo/derecho. | Indicar medida y tipo de plato instalado (Elevado o a ras de suelo).

**Para mayor anchura incremento de 20€ por cada 10cm. | Altura máxima 195cm. | IVA no incluido. Montaje no incluido. Precios en €.

DIDA 3

Cabina semicircular para ducha. Dos fijos y dos puertas correderas con cierre magnético en el centro.

REF.	Medidas en cm. X+Y	Acceso en cm.	PVP Cristal transparente	Fabricación
728R	De 77 a 80	42	496	
728I	De 77 a 80	42	496	
729R	De 87 a 90	50	524	
729I	De 87 a 90	50	524	

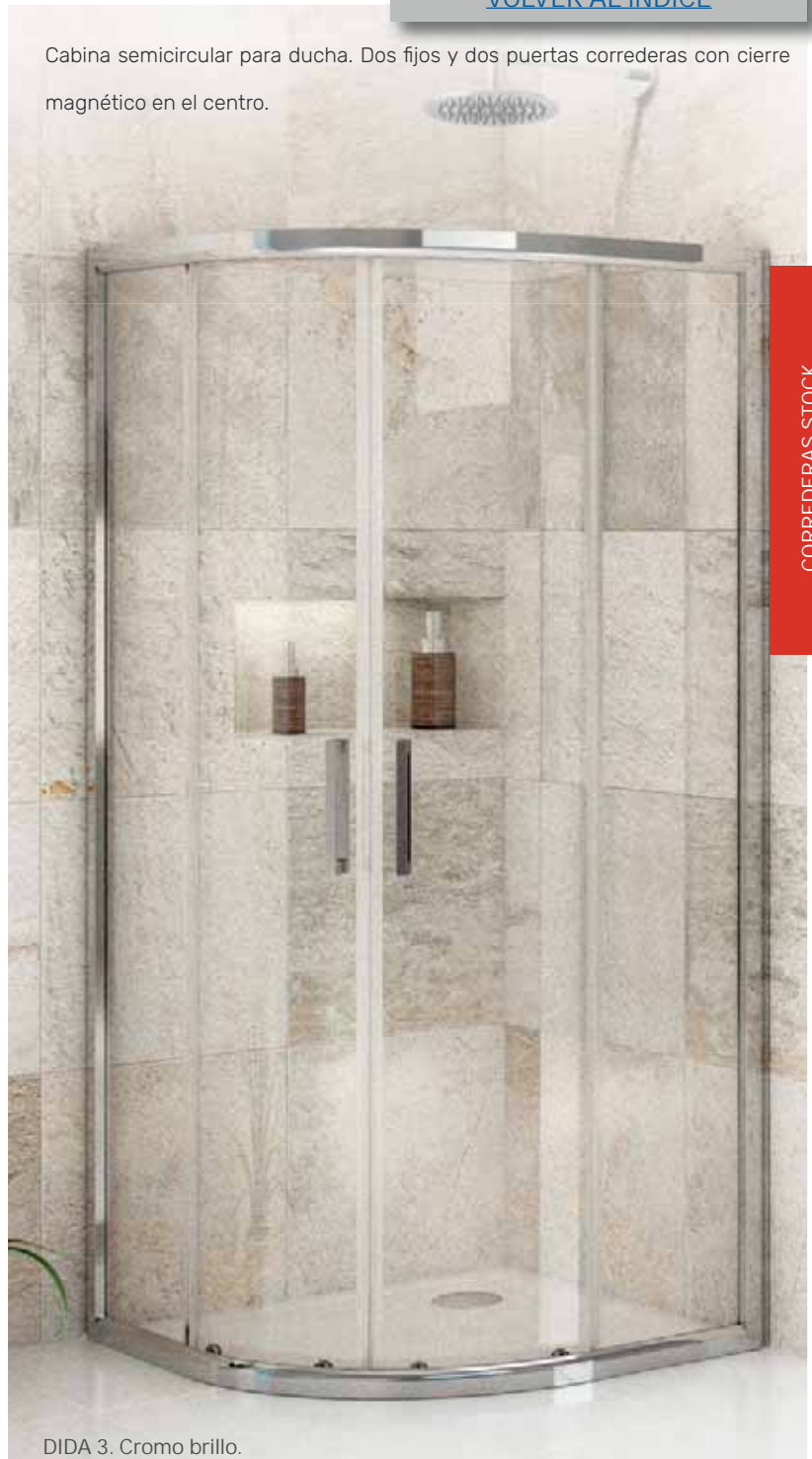
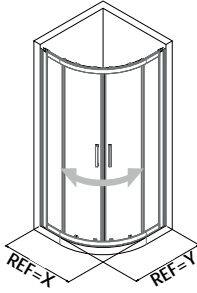

CORREDERAS STOCK

DIDA 3. Cromo brillo.



FICHA
TÉCNICA



INSTRUCCIONES
DE MONTAJE

+70€
PVP



*SERIGRAFÍA 1 Cromo brillo



ENTREGA
INMEDIATA



VIDRIO
TEMPLADO
6MM



TRATAMIENTO
ANTICAL
INCLUIDO



CIERRE
MAGNÉTICO



LIBERACIÓN
DE PUERTA



COMPENSACIÓN
POR LADO
3CM



CON GUÍA
INFERIOR



ALTURA
ÚNICA
195CM

R: Plato radio ROCA 50cm. I: Plato radio IDEAL 55cm. | Indicar medida y tipo de plato instalado (Elevado o a ras de suelo).

*Serigrafía 1: A, B, C, D, G, M, N y Q. | Altura única 195cm. | IVA no incluido. Montaje no incluido. Precios en €.

DIDA 4

REF.	Medidas en cm.	Acceso en cm.	PVP Cristal transparente	Fabricación
740	De 156 a 162	66	505	
741	De 162 a 168	69	522	
742	De 168 a 174	72	541	
743	De 174 a 180	75	559	
744	De 180 a 186	78	578	
745	De 186 a 192	81	599	
745ESP*	Hasta 198		719	

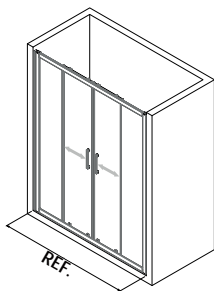

Frontal de ducha. Dos fijos y dos puertas correderas con cierre magnético en el centro.



DIDA 4. Cromo brillo.



[FICHA
TÉCNICA](#)



[INSTRUCCIONES
DE MONTAJE](#)

+70€
PVP

SERIGRAFÍA 1

+100€
PVP

SERIGRAFÍA 2



Cromo brillo



ENTREGA
INMEDIATA



FABRICACIÓN
A MEDIDA



VIDRIO
TEMPLADO
6MM



TRATAMIENTO
ANTICAL
INCLUIDO



CIERRE
MAGNÉTICO



LIBERACIÓN
DE PUERTA



COMPENSACIÓN
POR LADO
3CM



CON GUÍA
INFERIOR



ALTURA
195CM

*Para mayor anchura incremento de 20€ por cada 10cm (Anchura máxima 210cm). | Altura máxima 195cm.

IVA no incluido. Montaje no incluido. Precios en €.

PANEL DIDA

Panel fijo lateral para formar cabina con DIDA 1.

REF.	Medidas en cm.	PVP Cristal transparente	Fabricación
720	De 66 a 72	215	
721	De 76 a 82	231	
722	De 86 a 92	248	
721ESP	Hasta 86	231	
722ESP*	Hasta 120	319	

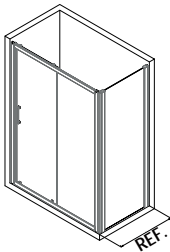
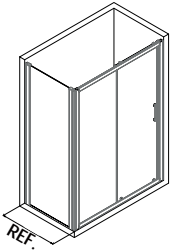

PANEL + DIDA 1. Cromo brillo.



EICHA
TÉCNICA

+40€
PVP

SERIGRAFÍA 1

+70€
PVP

SERIGRAFÍA 2

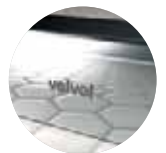

Cromo brillo



ENTREGA
INMEDIATA



FABRICACIÓN
A MEDIDA



VIDRIO
TEMPLADO
6MM



TRATAMIENTO
ANTICAL
INCLUIDO



COMPENSACIÓN
POR LADO
3CM



SIN GUÍA
INFERIOR



ALTURA
ÚNICA
195CM

Indicar lado derecho/izquierdo. | Indicar medida y tipo de plato instalado (Elevado o a ras de suelo). | Altura máxima 195cm.

*Para mayor anchura incremento de 30€ por cada 10cm. | IVA no incluido. Montaje no incluido. Precios en €.

Serie ORION

Mamparas para ducha de entrega inmediata. Vidrio templado de 8mm para los fijos y 6mm para las puertas correderas con tratamiento antical de serie. Perfilería minimalista sin guía inferior.

ORION 1

Frontal de ducha. Un fijo y una puerta corredera.

REF.	Medidas en cm.	PVP Cristal transparente
400	De 102 a 106	401
401	De 106 a 110	408
402	De 110 a 114	415
403	De 114 a 118	423
404	De 118 a 122	431
405	De 122 a 126	437
406	De 126 a 130	446
407	De 130 a 134	454
408	De 134 a 138	461
409	De 138 a 142	469
410	De 142 a 146	476
411	De 146 a 150	484
412	De 150 a 154	491
413	De 154 a 158	499
414	De 158 a 162	507
415	De 162 a 166	515
416	De 166 a 170	522
417	De 170 a 174	529
418	De 174 a 178	538
419	De 178 a 182	544
420	De 182 a 186	552



FICHA
TÉCNICA



INSTRUCCIONES
DE MONTAJE

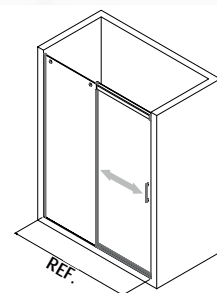
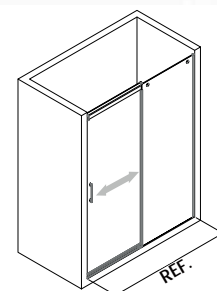

+50€
PVP

SERIGRAFÍA 1

+80€
PVP

SERIGRAFÍA 2



Cromo brillo



ENTREGA
INMEDIATA



VIDRIO
TEMPLADO
8MM y 6MM



TRATAMIENTO
ANTICAL
INCLUIDO



CIERRE
MAGNÉTICO



LIBERACIÓN
DE PUERTA



COMPENSACIÓN
4CM



SIN GUÍA
INFERIOR



ALTURA
ÚNICA
195CM

Indicar lado del fijo. | Indicar medida exacta del hueco. | IVA no incluido. Montaje no incluido. Precios en €.



Soportes fijos cromados.



Rodamientos con regulación.



SERIGRAFÍAS
DISPONIBLES
SERIE ORION

CORREDERAS STOCK

ORION 1. Cromo brillo.

ORION 2

REF.	Medidas en cm. por lado	PVP* Cristal transparente
450	De 67 a 70	268
451	De 72 a 75	274
452	De 77 a 80	280
453	De 87 a 90	293
454	De 97 a 100	303
455	De 107 a 110	316
456	De 117 a 120	329
457	De 122 a 125	335
458	De 127 a 130	340
459	De 137 a 140	353

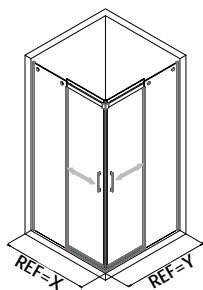

Angular de ducha. Dos fijos y dos puertas correderas con cierre magnético en el vértice.



ORION 2. Cromo brillo.



FICHA
TÉCNICA



INSTRUCCIONES
DE MONTAJE

+70€
PVP

SERIGRAFÍA 1
TOTAL 2 LADOS

+100€
PVP

SERIGRAFÍA 2
TOTAL 2 LADOS



Cromo brillo



ENTREGA
INMEDIATA



VIDRIO
TEMPLADO
8MM y 6MM



TRATAMIENTO
ANTICAL
INCLUIDO



CIERRE
MAGNÉTICO



LIBERACIÓN
DE PUERTA



COMPENSACIÓN
POR LADO
3CM



SIN GUÍA
INFERIOR





ALTURA
ÚNICA
195CM

*Precio por lado. | Precio total: sumar ambos lados X+Y. | Indicar lado izquierdo/derecho. | Indicar medida y tipo de plato instalado (Elevado o a ras de suelo).

IVA no incluido. Montaje no incluido. Precios en €.

PANEL ORION

Panel fijo lateral para formar cabina con ORION 1.

REF.	Medidas en cm.	PVP Cristal transparente	Fabricación
480	Hasta 60	258	
481	Hasta 80	281	
482	Hasta 100	305	

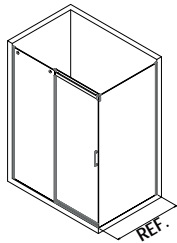
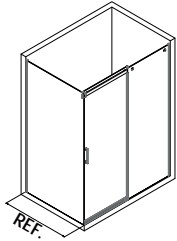

CORREDERAS STOCK

PANEL + ORION 1. Cromo brillo.



FICHA
TÉCNICA

+40€
PVP

SERIGRAFÍA 1

+70€
PVP

SERIGRAFÍA 2

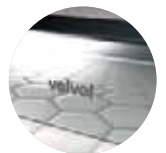

Cromo brillo



FABRICACIÓN
A MEDIDA



VIDRIO
TEMPLADO
8MM



TRATAMIENTO
ANTICAL
INCLUIDO



COMPENSACIÓN
1CM



SIN GUÍA
INFERIOR



ALTURA
195CM

Indicar lado derecho/izquierdo. | Indicar medida y tipo de plato instalado (Elevado o a ras de suelo). | Para mayor altura o anchura incremento de 30€ por cada 10cm.

IVA no incluido. Montaje no incluido. Precios en €.

Serie TRIDENT

Mamparas para ducha de entrega inmediata. Vidrio templado de 6mm con tratamiento antical de serie.

Perfilería lateral con compensación, sin guía inferior.



Guía de gran robustez y triple rodamiento por puerta.



Perfiles laterales con compensación.



[SERIGRAFÍAS
DISPONIBLES
SERIE TRIDENT](#)



TRIDENT 1. Cromo brillo.

TRIDENT 1

REF.	Medidas en cm.	Acceso en cm.	PVP Cristal transparente
900	De 82 a 87	43	428
901	De 87 a 92	46	438
902	De 92 a 97	50	449
903	De 97 a 102	53	459
904	De 102 a 107	56	468
905	De 107 a 112	60	479
906	De 112 a 117	63	490
907	De 117 a 122	66	501
908	De 122 a 127	70	511
909	De 127 a 132	73	522
910	De 132 a 137	76	531
911	De 137 a 142	80	541
912	De 142 a 147	83	553
913	De 147 a 152	86	563
914	De 152 a 157	90	574
915	De 157 a 162	93	583

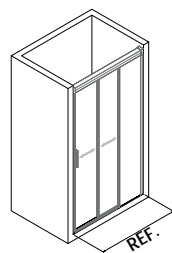
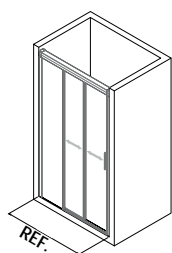

Frontal de ducha. Un fijo y dos puertas correderas con cierre magnético.



TRIDENT 1. Cromo brillo.



[FICHA TÉCNICA](#)



[INSTRUCCIONES DE MONTAJE](#)

+70€
PVP

SERIGRAFÍA 1

+100€
PVP

SERIGRAFÍA 2



Cromo brillo



ENTREGA INMEDIATA



VIDRIO TEMPLADO 6MM



TRATAMIENTO ANTICAL INCLUIDO



CIERRE MAGNÉTICO



LIBERACIÓN DE PUERTA



COMPENSACIÓN POR LADO 2,5CM



SIN GUÍA INFERIOR



ALTURA ÚNICA 195CM

Indicar lado del fijo. | IVA no incluido. Montaje no incluido. Precios en €.

PANEL TRIDENT

Panel fijo lateral para formar cabina con TRIDENT 1.

REF.	Medidas en cm.	PVP Cristal transparente	Fabricación
920	De 66 a 71	193	
921	De 76 a 81	204	
922	De 86 a 91	230	
921ESP	Hasta 86	204	
922ESP*	Hasta 120	375	

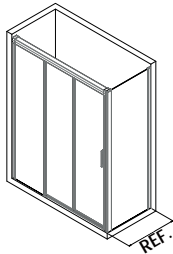
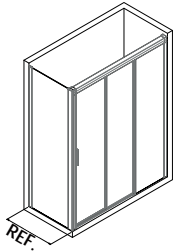

PANEL + TRIDENT 1. Cromo brillo.

CORREDERAS STOCK



FICHA TÉCNICA

+40€
PVP

SERIGRAFÍA 1

+70€
PVP

SERIGRAFÍA 2

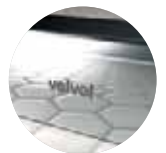

Cromo brillo



ENTREGA INMEDIATA



FABRICACIÓN A MEDIDA



VIDRIO TEMPLADO 6MM



TRATAMIENTO ANTICAL INCLUIDO



COMPENSACIÓN POR LADO 2,5CM



SIN GUÍA INFERIOR



ALTURA 195CM

Indicar lado derecho/izquierdo. | Indicar medida y tipo de plato instalado (Elevado o a ras de suelo). | Altura máxima 195cm.

*Para mayor anchura incremento de 30€ por cada 10cm. | IVA no incluido. Montaje no incluido. Precios en €.



FABRICACIÓN
A MEDIDA

Serie LUR

Mamparas para ducha o bañera de fabricación a medida. Vidrio templado de 8mm para los fijos y 6mm para las puertas correderas. Sin guía inferior y cierre suave mediante freno hidráulico opcional. Perfilería minimalista, y acabados de alta calidad.



Perfilería minimalista.



Codo de unión + Opción con frenos hidráulicos.



SERIGRAFÍAS
DISPONIBLES
SERIE LUR

Para otras composiciones especiales de LUR, ver la página 54.



3 ACABADOS
SIN INCREMENTOS

CORREDERAS MÍNIMA PERFILERÍA

LUR 1

Frontal de ducha o bañera. Un fijo y una puerta corredera.



FICHA
TÉCNICA



INSTRUCCIONES
DE MONTAJE

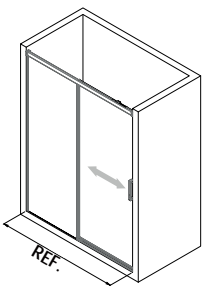
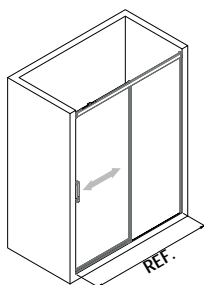

LUR 1. Plata brillo.

REF.	Medidas en cm.	PVP Cristal transparente
2510	Hasta 120	556
2511	Hasta 150	616
2512	Hasta 180	678
2513	Hasta 210	740



SERIGRAFÍA 1



SERIGRAFÍA 2



Plata brillo



Negro

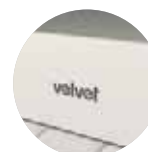

Blanco



FABRICACIÓN
A MEDIDA



VIDRIO
TEMPLADO
8MM y 6MM



TRATAMIENTO
ANTICAL
OPCIONAL
+70€



CIERRE
MAGNÉTICO
OPCIONAL
(Ver pág. 151)



LIBERACIÓN
DE PUERTA



SIN GUÍA
INFERIOR



ALTURA
195CM



CIERRE SUAVE
OPCIONAL
+50€



APTO PARA
ENCAJE
+85€



ALTURA
150CM
-15%

Indicar lado del fijo. | Indicar medida exacta del hueco. | Para mayor altura o anchura incremento de 20€ por cada 10cm. | IVA no incluido. Montaje no incluido. Precios en €.

LUR 2

Cabina de ducha o bañera. Dos fijos y una puerta corredera con cierre magnético al fijo lateral.



FICHA TÉCNICA



INSTRUCCIONES DE MONTAJE

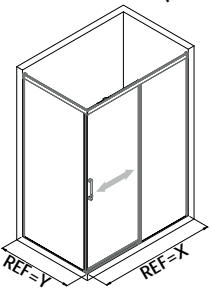
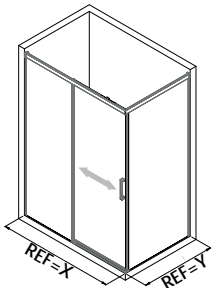

CORREDERAS MÍNIMA PERFILERÍA

LUR 2. Negro. SERIGRAFÍA 2 G

REF.	Medidas en cm. X+Y	PVP Cristal transparente
2520	Hasta 180	781
2521	Hasta 210	843
2522	Hasta 240	904



SERIGRAFÍA 1



SERIGRAFÍA 2



Plata brillo

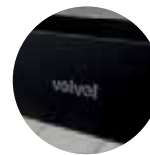

Negro



Blanco



FABRICACIÓN A MEDIDA



VIDRIO TEMPLADO 8MM y 6MM



TRATAMIENTO ANTICAL OPCIONAL +90€



LIBERACIÓN DE PUERTA



CIERRE MAGNÉTICO



SIN GUÍA INFERIOR



ALTURA 195CM



CIERRE SUAVE OPCIONAL +50€



APTO PARA ENCAJE +85€



ALTURA 150CM -15%€

Indicar lado del fijo lateral. | Indicar medida y tipo de plato instalado (Elevado o a ras de suelo). | Para mayor altura o anchura incremento de 20€ por cada 10cm.

IVA no incluido. Montaje no incluido. Precios en €.

LUR 2B

Cabina de ducha o bañera. Dos fijos y una puerta corredera con cierre hacia la pared.



FICHA TÉCNICA



INSTRUCCIONES DE MONTAJE

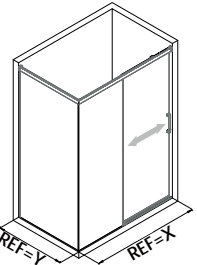
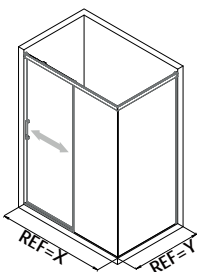

LUR 2B. Plata brillo.

REF.	Medidas en cm. X+Y	PVP Cristal transparente
2525	Hasta 180	781
2526	Hasta 210	843
2527	Hasta 240	904



SERIGRAFÍA 1



SERIGRAFÍA 2

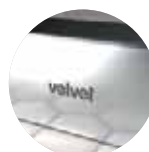

Plata brillo



Negro

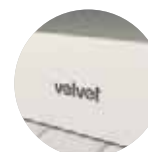

Blanco



FABRICACIÓN A MEDIDA



VIDRIO TEMPLADO 8MM y 6MM



TRATAMIENTO ANTICAL OPCIONAL +90€



CIERRE MAGNÉTICO OPCIONAL (Ver pág. 151)



LIBERACIÓN DE PUERTA



SIN GUÍA INFERIOR



ALTURA 195CM



CIERRE SUAVE OPCIONAL +50€



APTO PARA ENCAJE +85€



ALTURA 150CM -15%€

Indicar lado del fijo lateral. | Indicar medida y tipo de plato instalado (Elevado o a ras de suelo). | Para mayor altura o anchura incremento de 20€ por cada 10cm.

IVA no incluido. Montaje no incluido. Precios en €.

LUR 3

Angular de ducha o bañera. Dos fijos y dos puertas correderas con cierre magnético en el vértice.



FICHA
TÉCNICA



INSTRUCCIONES
DE MONTAJE

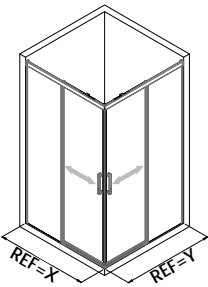

CORREDERAS MÍNIMA PERFILERÍA

LUR 3. Plata brillo.

REF.	Medidas en cm. X+Y	PVP Cristal transparente
2190	Hasta 180	792
2191	Hasta 210	953
2192	Hasta 240	914



SERIGRAFÍA 1



SERIGRAFÍA 2



Plata brillo

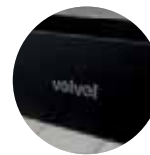

Negro



Blanco



FABRICACIÓN
A MEDIDA



VIDRIO
TEMPLADO
8MM y 6MM



TRATAMIENTO
ANTICAL
OPCIONAL
+90€



LIBERACIÓN
DE PUERTA



CIERRE
MAGNÉTICO



SIN GUÍA
INFERIOR



ALTURA
195CM



CIERRE SUAVE
OPCIONAL
+70€



APTO PARA
ENCAJE
+85€



ALTURA
150CM
-15%€

Indicar lado derecho/izquierdo. | Indicar medida y tipo de plato instalado (Elevado o a ras de suelo). | Para mayor altura o anchura incremento de 20€ por cada 10cm.
IVA no incluido. Montaje no incluido. Precios en €.

LUR 4

Frontal de ducha o bañera. Dos fijos y dos puertas correderas con cierre magnético en el centro.



FICHA
TÉCNICA



INSTRUCCIONES
DE MONTAJE

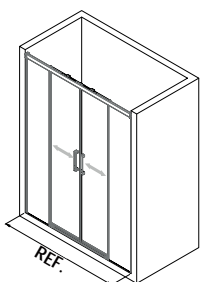

LUR 4. Plata brillo.

REF.	Medidas en cm.	PVP Cristal transparente
2530	Hasta 130	761
2531	Hasta 160	823
2532	Hasta 190	884
2533	Hasta 220	945



SERIGRAFÍA 1



SERIGRAFÍA 2

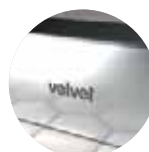

Plata brillo



Negro

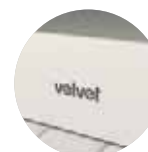

Blanco



FABRICACIÓN
A MEDIDA

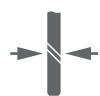

VIDRIO
TEMPLADO
8MM y 6MM



TRATAMIENTO
ANTICAL
OPCIONAL
+90€



LIBERACIÓN
DE PUERTA



CIERRE
MAGNÉTICO



SIN GUÍA
INFERIOR



ALTURA
195CM



CIERRE SUAVE
OPCIONAL
+70€



APTO PARA
ENCAJE
+85€



ALTURA
150CM
-15%€

Indicar medida exacta del hueco. | Para mayor altura o anchura incremento de 20€ por cada 10cm. | IVA no incluido. Montaje no incluido. Precios en €.

LUR 5

Frontal de ducha o bañera. Dos fijos y una puerta corredera central. Cierre al fijo.



FICHA
TÉCNICA



INSTRUCCIONES
DE MONTAJE

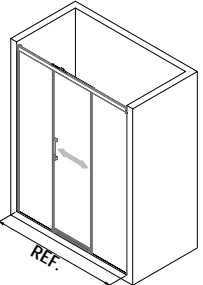
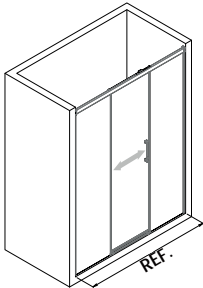

CORREDERAS MÍNIMA PERFILERÍA

LUR 5. Blanco.

REF.	Medidas en cm.	PVP Cristal transparente
2540	Hasta 150	781
2541	Hasta 180	843
2542	Hasta 220	904



SERIGRAFÍA 1



SERIGRAFÍA 2



Plata brillo



Negro



Blanco



FABRICACIÓN
A MEDIDA



VIDRIO
TEMPLADO
8MM y 6MM



TRATAMIENTO
ANTICORROSIÓN
OPCIONAL
+90€



LIBERACIÓN
DE PUERTA



SIN GUÍA
INFERIOR



ALTURA
195CM



CIERRE SUAVE
OPCIONAL
+50€



APTO PARA
ENCAJE
+85€



ALTURA
150CM
-15%€

Indicar medida exacta del hueco. | Indicar medida de fijo de cierre y lado. | Para mayor altura o anchura incremento de 20€ por cada 10cm.

IVA no incluido. Montaje no incluido. Precios en €.

LUR | OTRAS COMPOSICIONES ESPECIALES*



A. LUR 5. Negro. + PANEL LATERAL + DOBLE ENCAJE.

*Consultar para cualquier composición especial.



CORREDERAS MÍNIMA PERFILERÍA

B. LUR 3. Negro. + PANEL LATERAL + ENCAJE



C. LUR 2 BAÑERA. Blanco. + OPCIÓN POMO EXTRAPLANO + OPCIÓN TOALLERO.

*Consultar para cualquier composición especial.



FABRICACIÓN
A MEDIDA

Serie ROLLER

Mamparas para ducha o bañera de fabricación a medida. Vidrio templado de 8mm para los fijos y para las puertas correderas. Guía inferior minimalista. Elementos de alta calidad y prestaciones.



Detalle del rodamiento + guía superior + tensor a pared.



Rodamiento inferior.



[SERIGRAFÍAS
DISPONIBLES
SERIE ROLLER](#)

Para otras composiciones especiales de ROLLER, ver la página 62.



CORREDERAS MÍNIMA PERFILERÍA

ROLLER 3. Cromo brillo.

ROLLER 1

Frontal de ducha o bañera. Un fijo y una puerta corredera.



FICHA TÉCNICA



INSTRUCCIONES DE MONTAJE

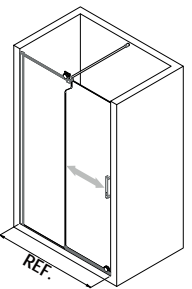
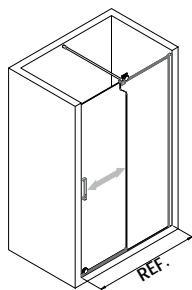

ROLLER 1. Cromo brillo.

REF.	Medidas en cm.	PVP Cristal transparente
4200S	Hasta 120	865
4201S	Hasta 150	952
4202S	Hasta 180	1.040

+50€
PVP

SERIGRAFÍA 1

+80€
PVP

SERIGRAFÍA 2



Cromo brillo



FABRICACIÓN A MEDIDA



VIDRIO TEMPLADO 8MM



CIERRE MAGNÉTICO OPCIONAL (Ver pág. 151)



TRATAMIENTO ANTICAL OPCIONAL +70€



ALTURA 195CM



ALTURA 150CM -15%€

Indicar lado del fijo. | Indicar medida exacta del hueco. | Para mayor altura o anchura incremento de 30€ cada 10cm. | IVA no incluido. Montaje no incluido. Precios en €.

ROLLER 2

Cabina de ducha o bañera. Dos fijos y una puerta corredera con cierre magnético al fijo lateral.



FICHA TÉCNICA



INSTRUCCIONES DE MONTAJE

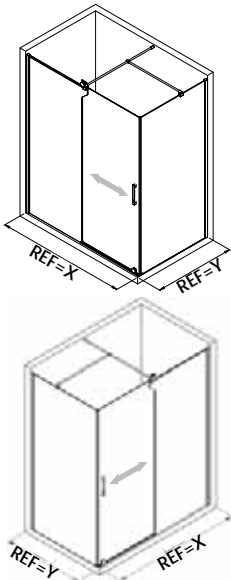

CORREDERAS MÍNIMA PERFILERÍA

ROLLER 2. Cromo brillo.

REF.	Medidas en cm. X+Y	PVP Cristal transparente
4210S	Hasta 180	1.190
4211S	Hasta 210	1.278
4212S	Hasta 240	1.367



SERIGRAFÍA 1



SERIGRAFÍA 2



Cromo brillo



FABRICACIÓN A MEDIDA



VIDRIO TEMPLADO 8MM



TRATAMIENTO ANTICAL OPCIONAL +90€



CIERRE MAGNÉTICO



ALTURA 195CM



ALTURA 150CM -15%€

Indicar lado del fijo lateral. | Indicar medida y tipo de plato instalado (Elevado o a ras de suelo). | Para mayor altura o anchura incremento de 30€ por cada 10cm. IVA no incluido. Montaje no incluido. Precios en €.

ROLLER 3

Angular de ducha o bañera. Dos fijos y dos puerta correderas con cierre magnético en el vértice.



FICHA
TÉCNICA



INSTRUCCIONES
DE MONTAJE

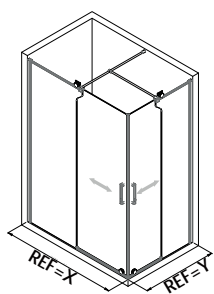

ROLLER 3. Cromo brillo.

REF.	Medidas en cm. X+Y	PVP Cristal transparente
4220S	Hasta 180	1.341
4221S	Hasta 210	1.429
4222S	Hasta 240	1.516

+70€
PVP

SERIGRAFÍA 1

+100€
PVP

SERIGRAFÍA 2

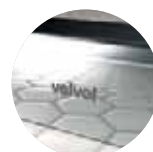

Cromo brillo



FABRICACIÓN
A MEDIDA



VIDRIO
TEMPLADO
8MM



TRATAMIENTO
ANTICAL
OPCIONAL
+90€



CIERRE
MAGNÉTICO



ALTURA
195CM



ALTURA
150CM
-15%€

Indicar lado derecho/izquierdo. | Indicar medida y tipo de plato instalado (Elevado o a ras de suelo). | Para mayor altura o anchura incremento de 30€ por cada 10cm.

IVA no incluido. Montaje no incluido. Precios en €.

ROLLER 4

Frontal de ducha o bañera. Dos fijos y dos puertas correderas con cierre magnético en el centro.



FICHA
TÉCNICA



INSTRUCCIONES
DE MONTAJE

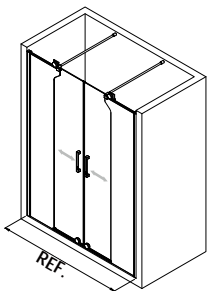

REF.



CORREDERAS MÍNIMA PERFILERA

ROLLER 4. Cromo brillo.

REF.	Medidas en cm.	PVP Cristal transparente
4230S	Hasta 130	1.292
4231S	Hasta 160	1.378
4232S	Hasta 190	1.466
4233S	Hasta 220	1.554



SERIGRAFÍA 1



SERIGRAFÍA 2



Cromo brillo



FABRICACIÓN
A MEDIDA



VIDRIO
TEMPLADO
8MM



TRATAMIENTO
ANTICAL
OPCIONAL
+90€



CIERRE
MAGNÉTICO



ALTURA
195CM



ALTURA
150CM
-15%€

Indicar medida exacta del hueco. | Para mayor altura o anchura incremento de 30€ por cada 10cm. | IVA no incluido. Montaje no incluido. Precios en €.

ROLLER | OTRAS COMPOSICIONES ESPECIALES*



A. ROLLER 1. SIN CIERRE A PARED.

*Consultar para cualquier composición especial.



B. ROLLER 4 BAÑERA. Cromo brillo.

CORREDERAS MÍNIMA PERFILERÍA



31072 TOALLERO. Ver página 150.

C. ROLLER 2 ENCAJE. Cromo brillo. + OPCIÓN TOALLERO.

*Consultar para cualquier composición especial.



FABRICACIÓN
A MEDIDA

Serie RHEA

Mamparas para ducha o bañera de fabricación a medida. Vidrio templado de 8mm para los fijos y 6mm para las puertas correderas o plegables. Perfilería de diseño, sin guía inferior. Posibilidad de diversas composiciones.



Nuevos soportes en latón estampado.



Sección de la guía con 8 rodamientos por puerta.



[SERIGRAFÍAS
DISPONIBLES
SERIE RHEA](#)



CORREDERAS MÍNIMA PERFILERÍA

RHEA 6. Cromo brillo.

RHEA 1

Frontal de ducha o bañera. Un fijo y una puerta corredera.



FICHA
TÉCNICA



INSTRUCCIONES
DE MONTAJE

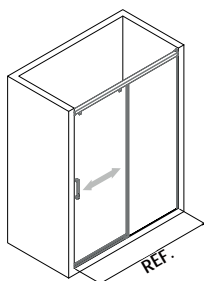

REF.

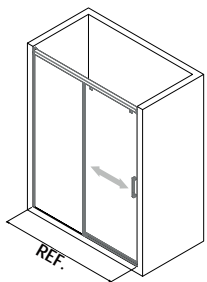

REF.



RHEA 1. Cromo brillo.

REF.	Medidas en cm.	PVP Cristal transparente
2200	Hasta 120	792
2201	Hasta 150	877
2202	Hasta 180	961
2203	Hasta 210	1.045



SERIGRAFÍA 1



SERIGRAFÍA 2

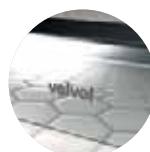

Cromo brillo



Negro +200€

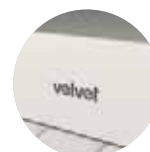

Blanco +200€



FABRICACIÓN
A MEDIDA



VIDRIO
TEMPLADO
8MM y 6MM



TRATAMIENTO
ANTICAL
OPCIONAL
+70€



CIERRE
MAGNÉTICO
OPCIONAL
(Ver pág. 151)



LIBERACIÓN
DE PUERTA



SIN GUÍA
INFERIOR



ALTURA
195CM



APTO PARA
ENCAJE
+85€



ALTURA
150CM
-15%€

Indicar lado del fijo. | Indicar medida exacta del hueco. | Para mayor altura o anchura incremento de 30€ por cada 10cm. | IVA no incluido. Montaje no incluido. Precios en €.

RHEA 2

Frontal de ducha o bañera. Dos fijos y una puerta corredera central. Cierre al fijo.



FICHA
TÉCNICA



INSTRUCCIONES
DE MONTAJE

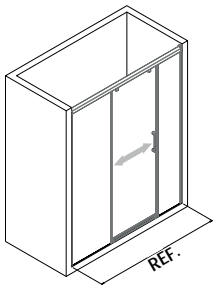

REF.

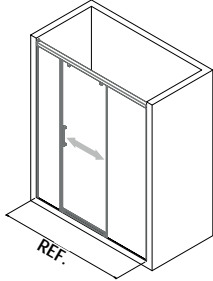

REF.



RHEA 2. Cromo brillo.

CORREDERAS MÍNIMA PERFILERÍA

REF.	Medidas en cm.	PVP Cristal transparente
2207	Hasta 150	979
2208	Hasta 180	1.062
2209	Hasta 210	1.146



SERIGRAFÍA 1



SERIGRAFÍA 2



Cromo brillo



Negro +240€



Blanco +240€



FABRICACIÓN
A MEDIDA



VIDRIO
TEMPLADO
8MM y 6MM



TRATAMIENTO
ANTICAL
OPCIONAL
+90€



LIBERACIÓN
DE PUERTA



SIN GUÍA
INFERIOR



ALTURA
195CM



APTO PARA
ENCAJE
+85€



ALTURA
150CM
-15%€

Indicar medida exacta del hueco. | Indicar medida de fijo de cierre y lado. | Para mayor altura o anchura incremento de 30€ por cada 10cm.

IVA no incluido. Montaje no incluido. Precios en €.

RHEA 3

Frontal de ducha o bañera. Dos fijos y dos puertas correderas con cierre magnético en el centro.



FICHA TÉCNICA



INSTRUCCIONES DE MONTAJE

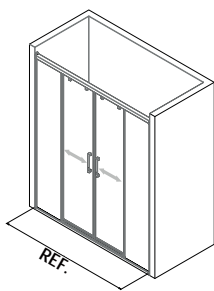

RHEA 3. Negro.

REF.	Medidas en cm.	PVP Cristal transparente
2210	Hasta 130	1.057
2211	Hasta 160	1.141
2212	Hasta 190	1.225
2213	Hasta 220	1.310

SERIGRAFÍA 1	SERIGRAFÍA 2	Cromo brillo	Negro +240€	Blanco +240€

FABRICACIÓN A MEDIDA	VIDRIO TEMPLADO 8MM y 6MM	TRATAMIENTO ANTICAL OPCIONAL +90€	LIBERACIÓN DE PUERTA	CIERRE MAGNÉTICO	SIN GUÍA INFERIOR	ALTURA 195CM	APTO PARA ENCAJE +85€	ALTURA 150CM -15%€

Indicar medida exacta del hueco. | Para mayor altura o anchura incremento de 30€ por cada 10cm. | IVA no incluido. Montaje no incluido. Precios en €.

RHEA 4

Cabina de ducha o bañera. Dos fijos y una puerta corredera con cierre magnético al fijo lateral.



FICHA
TÉCNICA



INSTRUCCIONES
DE MONTAJE

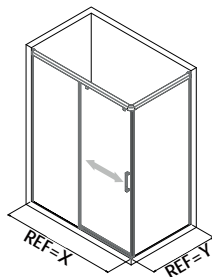
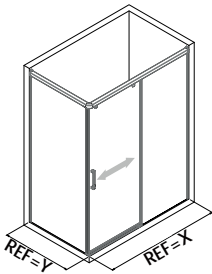

CORREDERAS MÍNIMA PERFILERÍA

RHEA 4. Cromo brillo.

REF.	Medidas en cm. X+Y	PVP Cristal transparente
2216	Hasta 180	1.057
2217	Hasta 210	1.141
2218	Hasta 240	1.225



SERIGRAFÍA 1



SERIGRAFÍA 2



Cromo brillo

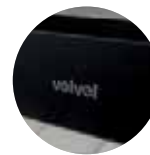

Negro +240€



Blanco +240€



FABRICACIÓN
A MEDIDA



VIDRIO
TEMPLADO
8MM y 6MM



TRATAMIENTO
ANTICAL
OPCIONAL
+90€



LIBERACIÓN
DE PUERTA



CIERRE
MAGNÉTICO



SIN GUÍA
INFERIOR



ALTURA
195CM



APTO PARA
ENCAJE
+85€



ALTURA
150CM
-15%€

Indicar lado del fijo lateral. | Indicar medida y tipo de plato instalado (Elevado o a ras de suelo). | Para mayor altura o anchura incremento de 30€ por cada 10cm.

IVA no incluido. Montaje no incluido. Precios en €.

RHEA 5

Cabina de ducha o bañera. Dos fijos y una puerta corredera con cierre hacia la pared.



FICHA
TÉCNICA



INSTRUCCIONES
DE MONTAJE

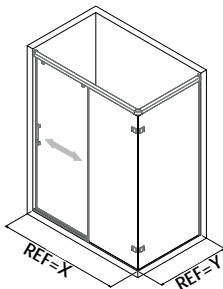
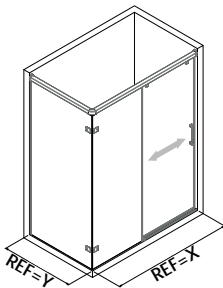

RHEA 5. Cromo brillo. SERIGRAFÍA 1 C

REF.	Medidas en cm. X+Y	PVP Cristal transparente
2223	Hasta 180	1.057
2224	Hasta 210	1.141
2225	Hasta 240	1.225



SERIGRAFÍA 1



SERIGRAFÍA 2



Cromo brillo

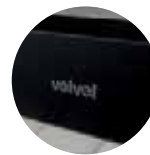

Negro +240€

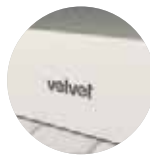

Blanco +240€



FABRICACIÓN
A MEDIDA



VIDRIO
TEMPLADO
8MM y 6MM



TRATAMIENTO
ANTICAL
OPCIONAL
+90€



CIERRE
MAGNÉTICO
OPCIONAL
(Ver pág. 151)



LIBERACIÓN
DE PUERTA



SIN GUÍA
INFERIOR



ALTURA
195CM



APTO PARA
ENCAJE
+85€



ALTURA
150CM
-15%€

Indicar lado del fijo lateral. | Indicar medida y tipo de plato instalado (Elevado o a ras de suelo). | Para mayor altura o anchura incremento de 30€ por cada 10cm.

IVA no incluido. Montaje no incluido. Precios en €.

RHEA 6

Angular de ducha o bañera. Dos fijos y dos puertas correderas con cierre magnético en el vértice.



FICHA
TÉCNICA



INSTRUCCIONES
DE MONTAJE

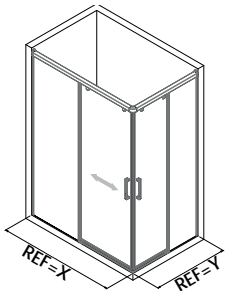

CORREDERAS MÍNIMA PERFILERÍA

RHEA 6. Cromo brillo.

REF.	Medidas en cm. X+Y	PVP Cristal transparente
2230	Hasta 180	1.081
2231	Hasta 210	1.165
2232	Hasta 240	1.250



SERIGRAFÍA 1



SERIGRAFÍA 2



Cromo brillo



Negro +320€



Blanco +320€



FABRICACIÓN
A MEDIDA



VIDRIO
TEMPLADO
8MM y 6MM



TRATAMIENTO
ANTICAL
OPCIONAL
+90€



LIBERACIÓN
DE PUERTA



CIERRE
MAGNÉTICO



SIN GUÍA
INFERIOR



ALTURA
195CM



APTO PARA
ENCAJE
+85€



ALTURA
150CM
-15%€

Indicar lado derecho/izquierdo. | Indicar medida y tipo de plato instalado (Elevado o a ras de suelo). | Para mayor altura o anchura incremento de 30€ por cada 10cm.

IVA no incluido. Montaje no incluido. Precios en €.

RHEA DÚPLEX 1

Frontal de ducha o bañera. Dos puertas correderas.



FICHA
TÉCNICA



INSTRUCCIONES
DE MONTAJE

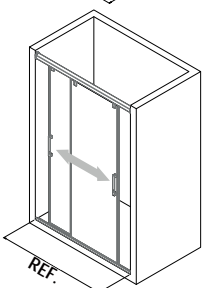
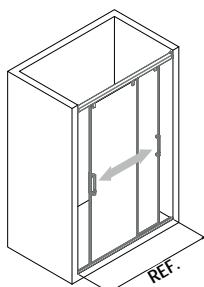

RHEA DÚPLEX 1. Cromo brillo.

REF.	Medidas en cm.	PVP Cristal transparente
2280	Hasta 130	950
2281	Hasta 160	1.030



SERIGRAFÍA 1



SERIGRAFÍA 2



Cromo brillo



Negro +240€

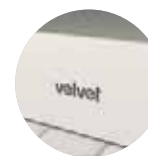

Blanco +240€



FABRICACIÓN
A MEDIDA



VIDRIO
TEMPLADO
6MM



TRATAMIENTO
ANTICAL
OPCIONAL
+70€



CIERRE
MAGNÉTICO
OPCIONAL
(Ver pág. 151)



LIBERACIÓN
DE PUERTA



SIN GUÍA
INFERIOR



ALTURA
195CM



ALTURA
150CM
-15%€

Indicar medida exacta del hueco. | Para mayor altura incremento de 30€ por cada 10cm. | Anchura máxima 160cm. | IVA no incluido. Montaje no incluido. Precios en €.

RHEA DÚPLEX 2

Frontal de ducha o bañera. Un fijo y dos puertas correderas con cierre magnético al fijo frontal.



FICHA TÉCNICA



INSTRUCCIONES DE MONTAJE

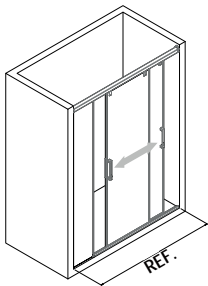

REF.

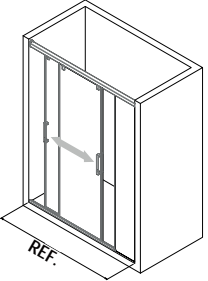

REF.



CORREDERAS MÍNIMA PERFILERÍA

RHEA DÚPLEX 2. Negro.

REF.	Medidas en cm.	PVP Cristal transparente
2285	Hasta 150	1.076
2286	Hasta 180	1.158



SERIGRAFÍA 1



SERIGRAFÍA 2



Cromo brillo



Negro +240€

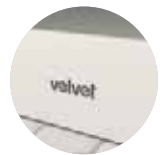

Blanco +240€



FABRICACIÓN A MEDIDA



VIDRIO TEMPLADO 8MM y 6MM



TRATAMIENTO ANTICAL OPCIONAL +90€



CIERRE A PARED MAGNÉTICO OPCIONAL (Ver pág. 151)



LIBERACIÓN DE PUERTA



CIERRE AL FIJO MAGNÉTICO



SIN GUÍA INFERIOR



ALTURA 195CM



APTO PARA ENCAJE +85€



ALTURA 150CM -15%€

Indicar medida exacta del hueco. | Indicar medida de fijo de cierre y lado. | Para mayor altura o anchura incremento de 30€ por cada 10cm.

IVA no incluido. Montaje no incluido. Precios en €.

RHEA DÚPLEX 3

Cabina de ducha o bañera. Dos fijos y dos puertas correderas con cierre magnético hacia el fijo frontal.



FICHA
TÉCNICA



INSTRUCCIONES
DE MONTAJE

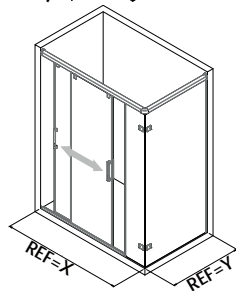
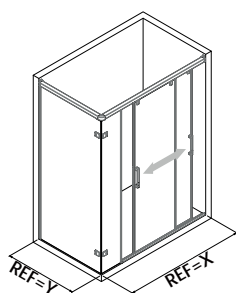

RHEA DÚPLEX 3. Cromo brillo.

REF.	Medidas en cm. X+Y	PVP Cristal transparente
2293	Hasta 220	1.389
2294	Hasta 240	1.470
2295	Hasta 280	1.552



SERIGRAFÍA 1



SERIGRAFÍA 2

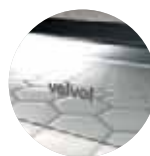

Cromo brillo



Negro +320€

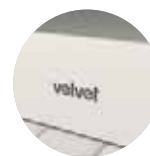

Blanco +320€



FABRICACIÓN
A MEDIDA



VIDRIO
TEMPLADO
8MM y 6MM



TRATAMIENTO
ANTICAL
OPCIONAL
+90€



CIERRE A PARED
MAGNÉTICO
OPCIONAL
(Ver pág. 151)



LIBERACIÓN
DE PUERTA



CIERRE AL FIJO
MAGNÉTICO



SIN GUÍA
INFERIOR



ALTURA
195CM



APTO PARA
ENCAJE
+85€



ALTURA
150CM
-15%€

Indicar medida y lado del fijo frontal y lateral. | Indicar medida y tipo de plato instalado (Elevado o a ras de suelo).

Para mayor altura o anchura incremento de 30€ por cada 10cm. | IVA no incluido. Montaje no incluido. Precios en €.

RHEA MIX 1

Frontal de ducha o bañera. Dos puertas plegables al interior con carril superior.



FICHA TÉCNICA



INSTRUCCIONES DE MONTAJE

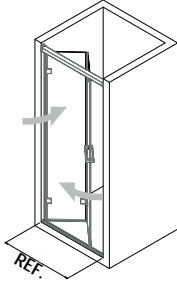
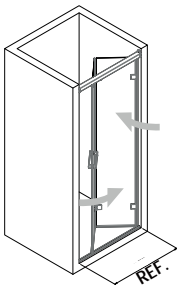

CORREDERAS MÍNIMA PERFILERÍA

RHEA MIX 1 Cromo brillo.

REF.	Medidas en cm.	PVP Cristal transparente
2240	Hasta 60	751
2241	Hasta 90	835



SERIGRAFÍA 1



SERIGRAFÍA 2



Cromo brillo

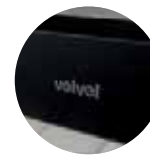

Negro +240€

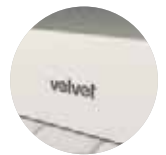

Blanco +240€



FABRICACIÓN A MEDIDA



VIDRIO TEMPLADO 6MM



TRATAMIENTO ANTICAL OPCIONAL +70€



SIN GUÍA INFERIOR



ALTURA 195CM



ALTURA 150CM -15%€

Indicar lado de la fijación. | Indicar medida exacta del hueco. | Para mayor altura o anchura incremento de 30€ por cada 10cm.

IVA no incluido. Montaje no incluido. Precios en €.

RHEA MIX 2

Frontal de ducha o bañera. Un fijo y dos puertas plegables al interior con carril superior.



FICHA TÉCNICA



INSTRUCCIONES DE MONTAJE

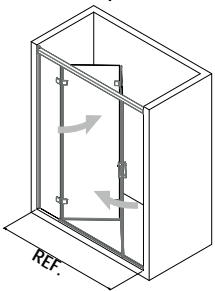
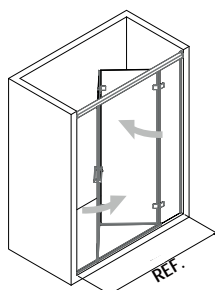

RHEA MIX 2. Cromo brillo.

REF.	Medidas en cm.	PVP Cristal transparente
2250	Hasta 90	961
2251	Hasta 120	1.045
2252	Hasta 150	1.130



SERIGRAFÍA 1



SERIGRAFÍA 2

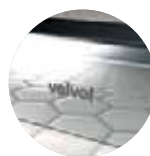

Cromo brillo



Negro +280€



Blanco +280€



FABRICACIÓN A MEDIDA

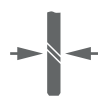

VIDRIO TEMPLADO 8MM y 6MM



TRATAMIENTO ANTICAL OPCIONAL +90€



SIN GUÍA INFERIOR



ALTURA 195CM



APTO PARA ENCAJE +85€



ALTURA 150CM -15%€

Indicar medida exacta del hueco. | Indicar medida de fijo y lado. | Para mayor altura o anchura incremento de 30€ por cada 10cm.

IVA no incluido. Montaje no incluido. Precios en €.

RHEA MIX 3

Angular de ducha o bañera. Un fijo con una puerta corredera y dos puertas plegables al interior con carril superior y cierre magnético en el vértice.



FICHA TÉCNICA



INSTRUCCIONES DE MONTAJE

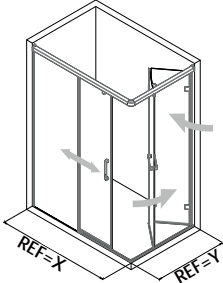
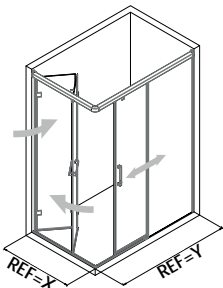

CORREDERAS MÍNIMA PERFILERÍA

RHEA MIX 3. Cromo brillo.

REF.	Medidas en cm. X+Y	PVP Cristal transparente
2260	Hasta 180	1.286
2261	Hasta 210	1.370
2262	Hasta 240	1.453



SERIGRAFÍA 1



SERIGRAFÍA 2



Cromo brillo

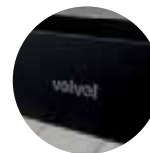

Negro +320€



Blanco +320€



FABRICACIÓN A MEDIDA



VIDRIO TEMPLADO 8MM y 6MM



TRATAMIENTO ANTICAL OPCIONAL +90€



CIERRE MAGNÉTICO



SIN GUÍA INFERIOR



ALTURA 195CM



ALTURA 150CM -15%€

Indicar lado izquierdo/derecho: corredera o plegable. | Indicar medida y tipo de plato instalado (Elevado o a ras de suelo).

Para mayor altura o anchura incremento de 30€ por cada 10cm. | IVA no incluido. Montaje no incluido. Precios en €.

RHEA MIX 4

Cabina de ducha o bañera. Un fijo y dos puertas plegables al interior con carril superior y cierre magnético al fijo lateral.



FICHA
TÉCNICA



INSTRUCCIONES
DE MONTAJE

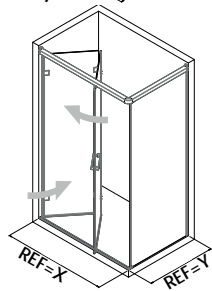
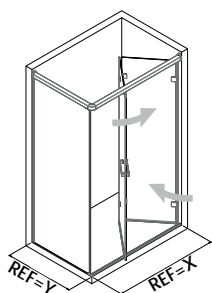

RHEA MIX 4. Cromo brillo.

REF.	Medidas en cm. X+Y	PVP Cristal transparente
2275	Hasta 160	1.057
2276	Hasta 180	1.141



SERIGRAFÍA 1



SERIGRAFÍA 2

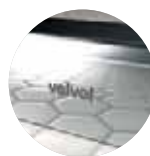

Cromo brillo



Negro +280€

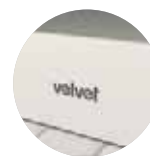

Blanco +280€



FABRICACIÓN
A MEDIDA



VIDRIO
TEMPLADO
8MM y 6MM



TRATAMIENTO
ANTICAL
OPCIONAL
+90€



CIERRE
MAGNÉTICO



SIN GUÍA
INFERIOR



ALTURA
195CM



APTO PARA
ENCAJE
+85€



ALTURA
150CM
-15%€

Indicar lado del fijo lateral. | Indicar medida y tipo de plato instalado (Elevado o a ras de suelo). | Para mayor altura o anchura incremento de 30€ por cada 10cm.

IVA no incluido. Montaje no incluido. Precios en €.

RHEA MIX 4B

Cabina de ducha o bañera. Un fijo y dos puertas plegables al interior con carril superior y cierre hacia la pared.



FICHA TÉCNICA



INSTRUCCIONES DE MONTAJE

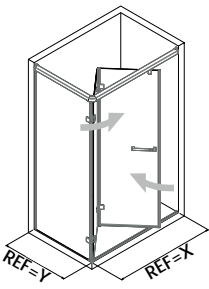
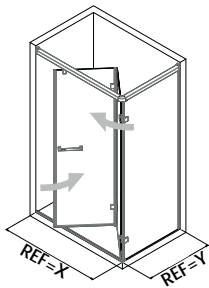

CORREDERAS MÍNIMA PERFILERÍA

RHEA MIX 4B. Negro.

REF.	Medidas en cm. X+Y	PVP Cristal transparente
2277	Hasta 160	1.057
2278	Hasta 180	1.141



SERIGRAFÍA 1



SERIGRAFÍA 2



Cromo brillo

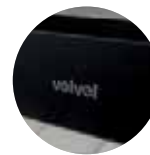

Negro +280€



Blanco +280€



FABRICACIÓN A MEDIDA



VIDRIO TEMPLADO 8MM y 6MM



TRATAMIENTO ANTICAL OPCIONAL +90€



SIN GUÍA INFERIOR



ALTURA 195CM



APTO PARA ENCAJE +85€



ALTURA 150CM -15%€

Indicar lado del fijo lateral. | Indicar medida y tipo de plato instalado (Elevado o a ras de suelo). | Para mayor altura o anchura incremento de 30€ por cada 10cm.

IVA no incluido. Montaje no incluido. Precios en €.



FABRICACIÓN
A MEDIDA

Serie ARES

Mamparas para ducha o bañera de fabricación a medida. Vidrio templado de 8mm para los fijos y para las puertas correderas. Perfilera superior con carriles internos para las puertas. Sin guía inferior.



Guía de alto micraje y 8 rodamientos por puerta.



Soportes en latón estampado.



SERIGRAFÍAS
DISPONIBLES
SERIE ARES

Para otras composiciones especiales de ARES, ver la página 89.



CORREDERAS MÍNIMA PERFILERÍA

ARES 5. Cromo brillo.

ARES 1

Frontal de ducha o bañera. Un fijo y una puerta corredera.



FICHA
TÉCNICA



INSTRUCCIONES
DE MONTAJE

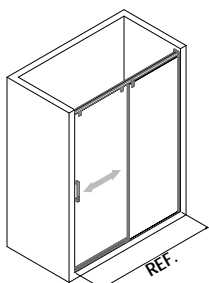

REF.

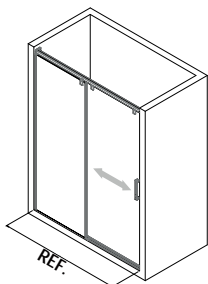

REF.



ARES 1. Cromo brillo.

REF.	Medidas en cm.	PVP Cristal transparente
3200	Hasta 120	849
3201	Hasta 150	928
3202	Hasta 180	1.009
3203	Hasta 210	1.089



SERIGRAFÍA 1



SERIGRAFÍA 2



Cromo brillo



Negro +240€

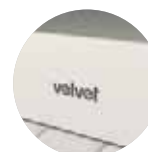

Blanco +240€



FABRICACIÓN
A MEDIDA



VIDRIO
TEMPLADO
8MM



TRATAMIENTO
ANTICAL
OPCIONAL
+70€



CIERRE
MAGNÉTICO
OPCIONAL
(Ver pág. 151)



LIBERACIÓN
DE PUERTA



SIN GUÍA
INFERIOR



ALTURA
195CM



APTO PARA
ENCAJE
+85€



ALTURA
150CM
-15%€

Indicar lado del fijo. | Indicar medida exacta del hueco. | Para mayor altura o anchura incremento de 30€ por cada 10cm. | IVA no incluido. Montaje no incluido. Precios en €.

ARES 2

Frontal de ducha o bañera. Dos fijos y una puerta corredera central. Cierre al fijo.



FICHA TÉCNICA



INSTRUCCIONES DE MONTAJE

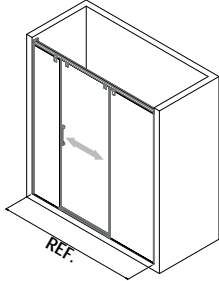
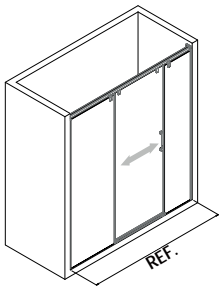

CORREDERAS MÍNIMA PERFILERÍA

ARES 2. Negro.

REF.	Medidas en cm.	PVP Cristal transparente
3207	Hasta 150	1.009
3208	Hasta 180	1.089
3209	Hasta 210	1.170



SERIGRAFÍA 1



SERIGRAFÍA 2



Cromo brillo



Negro +320€

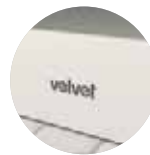

Blanco +320€



FABRICACIÓN A MEDIDA



VIDRIO TEMPLADO 8MM



TRATAMIENTO ANTICAL OPCIONAL +90€



LIBERACIÓN DE PUERTA



SIN GUÍA INFERIOR



ALTURA 195CM



APTO PARA ENCAJE +85€



ALTURA 150CM -15%€

Indicar medida exacta del hueco. | Indicar medida de fijo de cierre y lado. | Para mayor altura o anchura incremento de 30€ por cada 10cm.

IVA no incluido. Montaje no incluido. Precios en €.

ARES 3

Frontal de ducha o bañera. Dos fijos y dos puertas correderas con cierre magnético en el centro.



FICHA
TÉCNICA



INSTRUCCIONES
DE MONTAJE

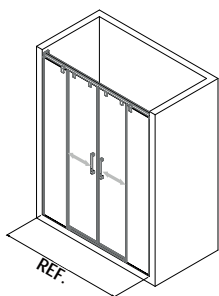

ARES 3. Cromo brillo.

REF.	Medidas en cm.	PVP Cristal transparente
3210	Hasta 130	1.124
3211	Hasta 160	1.204
3212	Hasta 190	1.284
3213	Hasta 220	1.365



SERIGRAFÍA 1



SERIGRAFÍA 2

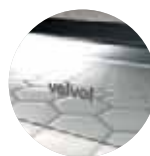

Cromo brillo



Negro +320€

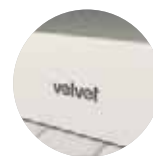

Blanco +320€



FABRICACIÓN
A MEDIDA



VIDRIO
TEMPLADO
8MM



TRATAMIENTO
ANTICORROSIÓN
OPCIONAL
+90€



LIBERACIÓN
DE PUERTA



CIERRE
MAGNÉTICO



SIN GUÍA
INFERIOR



ALTURA
195CM



APTO PARA
ENCAJE
+85€



ALTURA
150CM
-15%€

Indicar medida exacta del hueco. | Para mayor altura o anchura incremento de 30€ por cada 10cm. | IVA no incluido. Montaje no incluido. Precios en €.

ARES 4

Cabina de ducha o bañera. Dos fijos y una puerta corredera con cierre magnético al fijo lateral.



FICHA TÉCNICA



INSTRUCCIONES DE MONTAJE

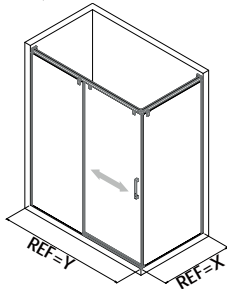
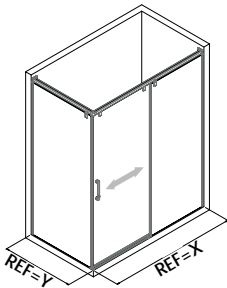

CORREDERAS MÍNIMA PERFILERÍA

ARES 4. Cromo brillo. SERIGRAFÍA 1 F

REF.	Medidas en cm. X+Y	PVP Cristal transparente
3216	Hasta 180	1.181
3217	Hasta 210	1.261
3218	Hasta 240	1.342



SERIGRAFÍA 1



SERIGRAFÍA 2



Cromo brillo

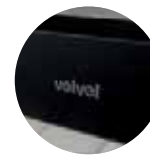

Negro +320€



Blanco +320€



FABRICACIÓN A MEDIDA



VIDRIO TEMPLADO 8MM



TRATAMIENTO ANTICAL OPCIONAL +90€



LIBERACIÓN DE PUERTA



CIERRE MAGNÉTICO



SIN GUÍA INFERIOR



ALTURA 195CM



APTO PARA ENCAJE +85€



ALTURA 150CM -15%€

Indicar lado del fijo lateral. | Indicar medida y tipo de plato instalado (Elevado o a ras de suelo). | Para mayor altura o anchura incremento de 30€ por cada 10cm.

IVA no incluido. Montaje no incluido. Precios en €.

ARES 5

Cabina de ducha o bañera. Dos fijos y una puerta corredera con cierre hacia la pared.



FICHA TÉCNICA



INSTRUCCIONES DE MONTAJE

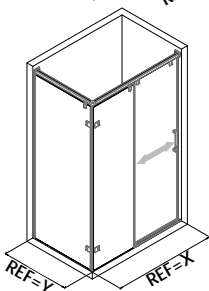
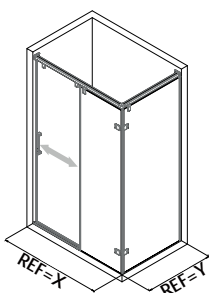

ARES 5. Negro.

REF.	Medidas en cm. X+Y	PVP Cristal transparente
3220	Hasta 180	1.181
3221	Hasta 210	1.261
3222	Hasta 240	1.342



SERIGRAFÍA 1



SERIGRAFÍA 2

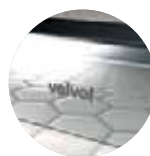

Cromo brillo



Negro +320€



Blanco +320€



FABRICACIÓN A MEDIDA



VIDRIO TEMPLADO 8MM



TRATAMIENTO ANTICAL OPCIONAL +90€



CIERRE MAGNÉTICO OPCIONAL (Ver pág. 151)



LIBERACIÓN DE PUERTA



SIN GUÍA INFERIOR



ALTURA 195CM



APTO PARA ENCAJE +85€



ALTURA 150CM -15%€

Indicar lado del fijo lateral. | Indicar medida y tipo de plato instalado (Elevado o a ras de suelo). | Para mayor altura o anchura incremento de 30€ por cada 10cm.

IVA no incluido. Montaje no incluido. Precios en €.

ARES 6

Angular de ducha o bañera. Dos fijos y dos puertas correderas con cierre magnético en el vértice.



FICHA
TÉCNICA



INSTRUCCIONES
DE MONTAJE

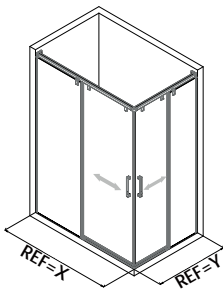

CORREDERAS MÍNIMA PERFILERIA

ARES 6. Cromo brillo.

REF.	Medidas en cm. X+Y	PVP Cristal transparente
3230	Hasta 180	1.227
3231	Hasta 210	1.307
3232	Hasta 240	1.387



SERIGRAFÍA 1



SERIGRAFÍA 2



Cromo brillo

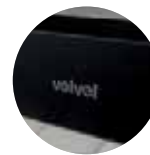

Negro +320€

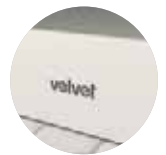

Blanco +320€



FABRICACIÓN
A MEDIDA



VIDRIO
TEMPLADO
8MM



TRATAMIENTO
ANTICAL
OPCIONAL
+90€



LIBERACIÓN
DE PUERTA



CIERRE
MAGNÉTICO



SIN GUÍA
INFERIOR



ALTURA
195CM



APTO PARA
ENCAJE
+85€



ALTURA
150CM
-15%€

Indicar lado derecho/izquierdo. | Indicar medida y tipo de plato instalado (Elevado o a ras de suelo). | Para mayor altura o anchura incremento de 30€ por cada 10cm.

IVA no incluido. Montaje no incluido. Precios en €.

ARES 7

Cabina semicircular para ducha. Dos fijos y dos puertas correderas con cierre magnético en el centro.



FICHA TÉCNICA



INSTRUCCIONES DE MONTAJE

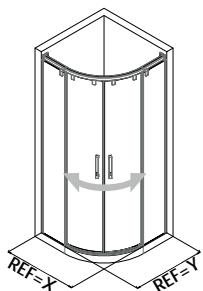

ARES 7. Cromo brillo.

REF.	Medidas en cm. X	Medidas en cm. Y	Acceso en cm.	PVP Cristal transparente
3290R	Hasta 90	Hasta 90	50	1.594
3290I	Hasta 90	Hasta 90	50	1.594
3291R	Hasta 110	Hasta 110	55	1.639
3291I	Hasta 110	Hasta 110	55	1.639

+70€
PVP



*SERIGRAFÍA 1

Cromo brillo



FABRICACIÓN A MEDIDA



VIDRIO TEMPLADO 8MM y 6MM



TRATAMIENTO ANTICAL OPCIONAL +90€



CIERRE MAGNÉTICO



SIN GUÍA INFERIOR



ALTURA ÚNICA 195CM



APTO PARA ENCAJE +85€

R: Plato radio ROCA 50cm. I: Plato radio IDEAL 55cm. | Indicar medida y tipo de plato instalado (Elevado o a ras de suelo). | Para mayor anchura incremento de 30€ por cada 10cm.

*Serigrafía 1: A, B, C, D, G, M, N y Q. | Altura única 195cm. | IVA no incluido. Montaje no incluido. Precios en €.

ARES | OTRAS COMPOSICIONES ESPECIALES*

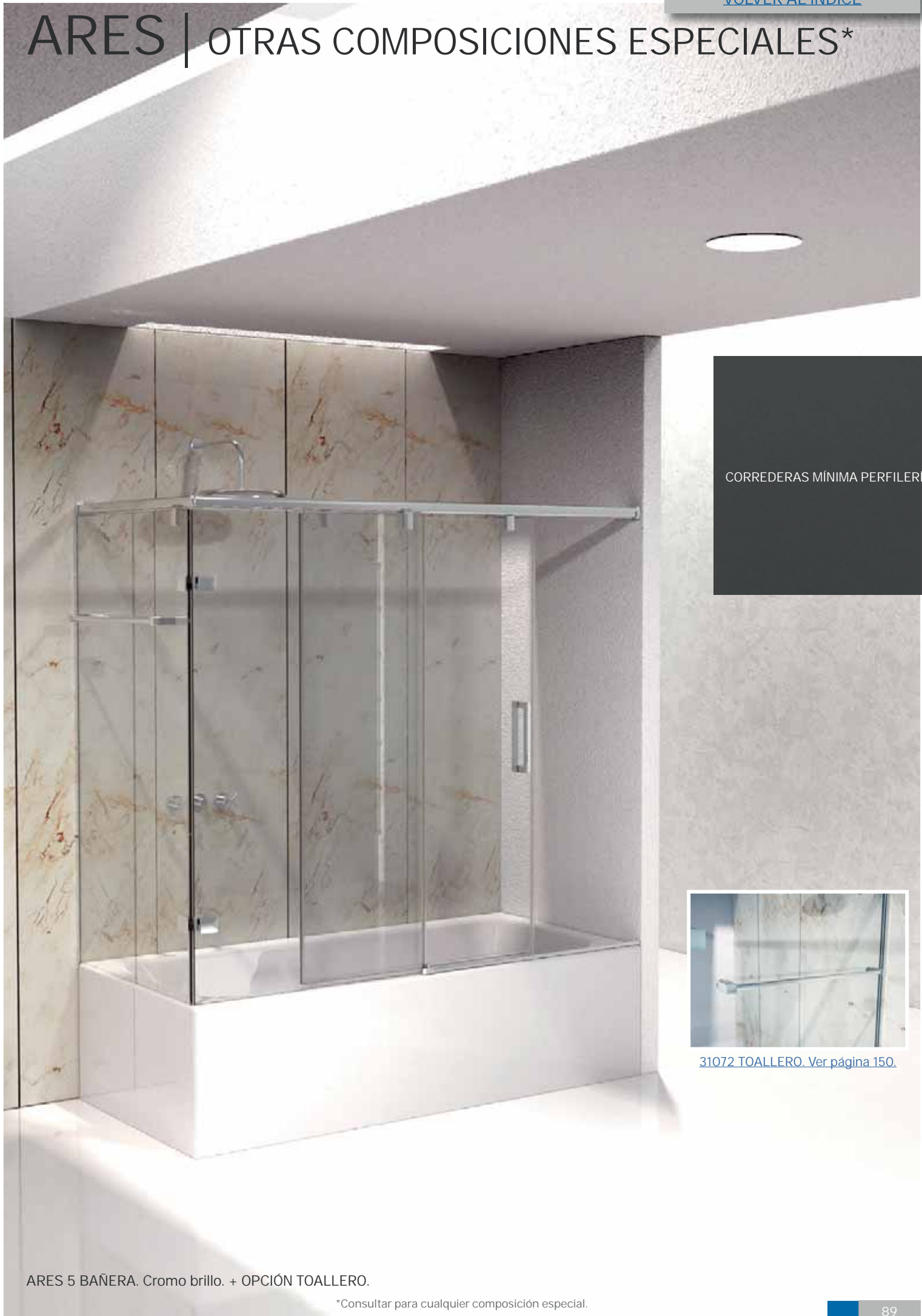

CORREDERAS MÍNIMA PERFILERÍA



[31072 TOALLERO. Ver página 150.](#)

ARES 5 BAÑERA. Cromo brillo. + OPCIÓN TOALLERO.

*Consultar para cualquier composición especial.

ABATIBLES

Series de mamparas abatibles para ducha o bañera de fabricación a medida.

[CAPELA | MERIT](#) 94

ABATIBLES ABISAGRADAS



FABRICACIÓN A MEDIDA



[CORA](#) 114

ABATIBLES PERFILERÍA LATERAL



FABRICACIÓN A MEDIDA



[SINOPE | NELA](#) 96

ABATIBLES ABISAGRADAS



FABRICACIÓN A MEDIDA



[POLUX](#) 116

ABATIBLES PERFILERÍA LATERAL



FABRICACIÓN A MEDIDA



[CASTOR | OMIX](#) 100

ABATIBLES ABISAGRADAS



FABRICACIÓN A MEDIDA



[URANIA 7](#) 131

ACRÍLICAS OPCIÓN CRISTAL



FABRICACIÓN A MEDIDA



[ARIEL 1](#) 108

ABATIBLES ABISAGRADAS



FABRICACIÓN A MEDIDA



[URANIA 8](#) 132

ACRÍLICAS OPCIÓN CRISTAL



FABRICACIÓN A MEDIDA



PLEGABLES

Series de mamparas plegables para ducha o bañera de fabricación a medida.

RHEA MIX

75

CORREDERAS MÍNIMA PERFILERÍA



FABRICACIÓN A MEDIDA



MIX 1

140

ACRÍLICAS OPCIÓN CRISTAL



FABRICACIÓN A MEDIDA



RORIS | SETI

104

ABATIBLES ABISAGRADAS



FABRICACIÓN A MEDIDA



ICRA 1

118

ABATIBLES PERFILERÍA LATERAL



FABRICACIÓN A MEDIDA



NISTE

136

ACRÍLICAS OPCIÓN CRISTAL



FABRICACIÓN A MEDIDA



Serie ABATIBLES ABISAGRADAS

Mamparas frontales y angulares para ducha y/o bañera de fabricación a medida. Vidrio templado de 6mm o 8mm para las puertas abatibles o plegables, con una alta posibilidad de personalización. Destaca por su minimalismo, diseño exclusivo y excelentes acabados. Las mamparas cuentan con bisagras de alta calidad en latón estampado. Sin guía inferior.



Bisagras en latón estampado de fabricación propia.



Pomos XENIA 12. Ver página 150.



[SERIGRAFÍAS
DISPONIBLES
SERIE ABATIBLES ABISAGRADAS](#)

Para otras composiciones especiales de ABISAGRADAS, ver la página 110.



FABRICACIÓN
A MEDIDA



3 ACABADOS
SIN INCREMENTOS



ABATIBLES ABISAGRADAS

CAPELA 1 | MERIT 1

Frontal de ducha o bañera. Una puerta de apertura exterior.



FICHA
TÉCNICA



INSTRUCCIONES
DE MONTAJE

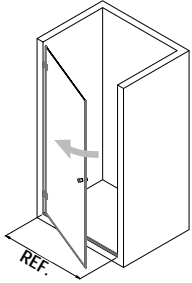
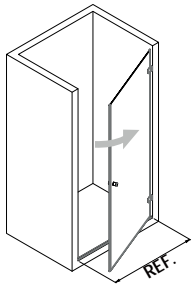

CAPELA 1 | MERIT 1. Negro.

REF.	Medidas en cm.	PVP Cristal transparente	Espesor
CAPELA 1			
2000	Hasta 80	422	6MM
2001	Hasta 100	469	6MM
MERIT 1			
1000	Hasta 80	548	8MM
1001	Hasta 100	609	8MM

+50€
PVP

SERIGRAFÍA 1

+80€
PVP

SERIGRAFÍA 2



Cromo brillo



Negro



Blanco

FABRICACIÓN
A MEDIDA

VIDRIO
TEMPLADO
6MM O 8MM

VIDRIO
TEMPLADO
OPCIONAL
10MM*

TRATAMIENTO
ANTICAL
OPCIONAL
+35€

CIERRE
MAGNÉTICO
OPCIONAL
(Ver pág. 151)

SIN GUÍA
INFERIOR

ALTURA
195CM

ALTURA
150CM
-15%€

BISAGRA 180°
OPCIONAL
+70€

Indicar lado de fijación. | Indicar medida exacta del hueco. | Para mayor altura o anchura incremento de 30€ por cada 10cm.

*OPCIONAL 10MM: Incremento de 30% sobre PVP Cristal transparente de 6MM. | IVA no incluido. Montaje no incluido. Precios en €.

CAPELA 3 | MERIT 3

Frontal de ducha o bañera. Dos puertas de apertura exterior con cierre magnético.



FICHA TÉCNICA



INSTRUCCIONES DE MONTAJE

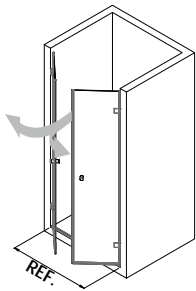

CAPELA 3 | MERIT 3. Cromo brillo.

ABATIBLES ABISAGRADAS

REF.	Medidas en cm.	PVP Cristal transparente	Espesor
CAPELA 3			
2090	Hasta 100	548	6MM
2091	Hasta 120	597	6MM
2092	Hasta 140	646	6MM
MERIT 3			
1006	Hasta 100	712	8MM
1007	Hasta 120	776	8MM
1008	Hasta 140	839	8MM

+50€
PVP

SERIGRAFÍA 1

+80€
PVP

SERIGRAFÍA 2



Cromo brillo

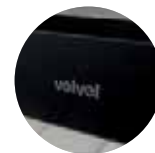

Negro



Blanco



FABRICACIÓN A MEDIDA



VIDRIO TEMPLADO 6MM o 8MM



VIDRIO TEMPLADO OPCIONAL 10MM*



TRATAMIENTO ANTICAL OPCIONAL +70€



CIERRE MAGNÉTICO



SIN GUÍA INFERIOR



ALTURA 195CM



ALTURA 150CM -15%€

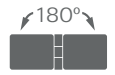

BISAGRA 180° OPCIONAL +140€

Indicar medida exacta del hueco. | Para mayor altura o anchura incremento de 30€ por cada 10cm.

*OPCIONAL 10MM: Incremento de 30% sobre PVP Cristal transparente de 6MM. | IVA no incluido. Montaje no incluido. Precios en €.

SINOPE 1 | NELA 11

Frontal de ducha o bañera. Un fijo con perfil de compensación y una puerta de apertura exterior.



FICHA TÉCNICA



INSTRUCCIONES DE MONTAJE

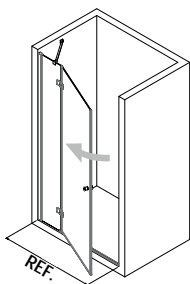
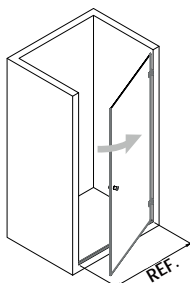

SINOPE 1 | NELA 11. Negro.

REF.	Medidas en cm.	PVP Cristal transparente	Espesor
SINOPE 1			
2020	Hasta 100	550	6MM
2021	Hasta 120	600	6MM
2022	Hasta 140	650	6MM
NELA 11			
1221	Hasta 100	715	8MM
1222	Hasta 120	780	8MM
1223	Hasta 140	845	8MM

+50€
PVP

SERIGRAFÍA 1

+80€
PVP

SERIGRAFÍA 2



Cromo brillo

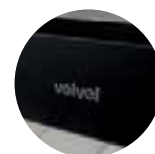

Negro



Blanco



FABRICACIÓN A MEDIDA



VIDRIO TEMPLADO 6MM O 8MM



VIDRIO TEMPLADO OPCIONAL 10MM*



TRATAMIENTO ANTICAL OPCIONAL +70€



CIERRE MAGNÉTICO OPCIONAL (Ver pág. 151)



COMPENSACIÓN 1CM



SIN GUÍA INFERIOR



ALTURA 195CM



APTO PARA ENCAJE +85€



ALTURA 150CM -15%€

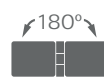

BISAGRA 180° OPCIONAL +70€



BISAGRAS FIJAS A PARED +35€

Indicar lado de fijación y medida del panel fijo. | Indicar medida exacta del hueco. | Para mayor altura o anchura incremento de 30€ por cada 10cm.

*OPCIONAL 10MM: Incremento de 30% sobre PVP Cristal transparente de 6MM. | IVA no incluido. Montaje no incluido. Precios en €.

SINOPE 4 | NELA 8

Frontal de ducha o bañera. Un fijo con perfil de compensación y una puerta de apertura exterior con cierre magnético al fijo.



FICHA TÉCNICA



INSTRUCCIONES DE MONTAJE

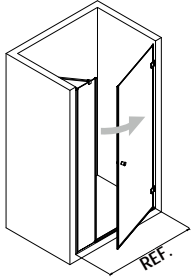
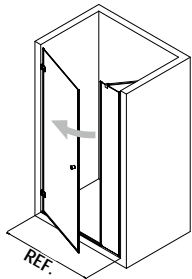

ABATIBLES ABISAGRADAS

SINOPE 4 | NELA 8. Cromo brillo.

REF.	Medidas en cm.	PVP Cristal transparente	Espesor
SINOPE 4			
2025	Hasta 100	540	6MM
2026	Hasta 120	590	6MM
2027	Hasta 140	640	6MM
NELA 8			
1245	Hasta 100	705	8MM
1246	Hasta 120	770	8MM
1247	Hasta 140	835	8MM

+50€
PVP

SERIGRAFÍA 1

+80€
PVP

SERIGRAFÍA 2



Cromo brillo



Negro

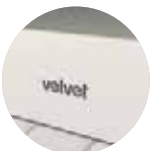

Blanco



FABRICACIÓN A MEDIDA



VIDRIO TEMPLADO 6MM O 8MM



VIDRIO TEMPLADO OPCIONAL 10MM*



TRATAMIENTO ANTICAL OPCIONAL +70€



CIERRE MAGNÉTICO



COMPENSACIÓN 1CM



SIN GUÍA INFERIOR



ALTURA 195CM



APTO PARA ENCAJE +85€



ALTURA 150CM -15%€

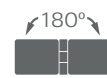

BISAGRA 180° OPCIONAL +70€



BISAGRAS FIJAS A PARED +35€

Indicar lado de fijación y medida del panel fijo. | Indicar medida exacta del hueco. | Para mayor altura o anchura incremento de 30€ por cada 10cm.

*OPCIONAL 10MM: Incremento de 30% sobre PVP Cristal transparente de 6MM. | IVA no incluido. Montaje no incluido. Precios en €.

SINOPE 5 | NELA 7

Frontal de ducha o bañera. Dos fijos con perfiles de compensación y una puerta central de apertura exterior con cierre magnético al fijo.



FICHA TÉCNICA



INSTRUCCIONES DE MONTAJE

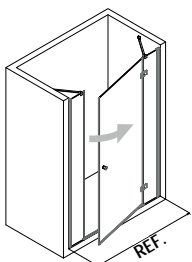
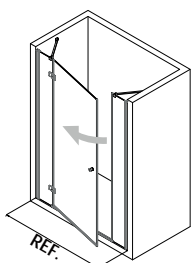

SINOPE 5 | NELA 7. Cromo brillo.

REF.	Medidas en cm.	PVP Cristal transparente	Espesor
SINOPE 5			
2009	Hasta 120	745	6MM
2010	Hasta 150	818	6MM
2011	Hasta 180	892	6MM
NELA 7			
1250	Hasta 120	968	8MM
1251	Hasta 150	1.063	8MM
1252	Hasta 180	1.159	8MM

+70€
PVP

SERIGRAFÍA 1

+100€
PVP

SERIGRAFÍA 2



Cromo brillo



Negro

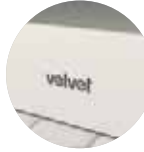

Blanco



FABRICACIÓN A MEDIDA



VIDRIO TEMPLADO 6MM o 8MM



VIDRIO TEMPLADO OPCIONAL 10MM*



TRATAMIENTO ANTICAL OPCIONAL +90€



CIERRE MAGNÉTICO



COMPENSACIÓN POR LADO 1CM



SIN GUÍA INFERIOR



ALTURA 195CM



APTO PARA ENCAJE +85€



ALTURA 150CM -15%€



BISAGRA 180° OPCIONAL +70€



BISAGRAS FIJAS A PARED +70€

Indicar lado de fijación de la puerta y medida de los paneles fijos. | Indicar medida exacta del hueco. | Para mayor altura o anchura incremento de 30€ por cada 10cm.

*OPCIONAL 10MM: incremento de 30% sobre PVP Cristal transparente de 6MM. | IVA no incluido. Montaje no incluido. Precios en €.

SINOPE 6 | NELA 12

Frontal de ducha o bañera. Dos fijos con perfiles de compensación y dos puertas de apertura exterior y cierre magnético.



FICHA TÉCNICA



INSTRUCCIONES DE MONTAJE

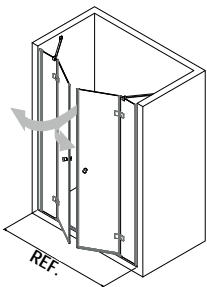

SINOPE 6 | NELA 12. Blanco.

ABATIBLES ABISAGRADAS

REF.	Medidas en cm.	PVP Cristal transparente	Espesor
SINOPE 6			
2003	Hasta 120	958	6MM
2004	Hasta 150	1.028	6MM
2005	Hasta 180	1.096	6MM
NELA 12			
1230	Hasta 120	1.245	8MM
1231	Hasta 150	1.337	8MM
1232	Hasta 180	1.425	8MM

+70€
PVP

SERIGRAFÍA 1

+100€
PVP

SERIGRAFÍA 2



Cromo brillo



Negro

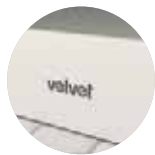

Blanco



FABRICACIÓN A MEDIDA



VIDRIO TEMPLADO 6MM O 8MM



VIDRIO TEMPLADO OPCIONAL 10MM*



TRATAMIENTO ANTICAL OPCIONAL +90€



CIERRE MAGNÉTICO



COMPENSACIÓN POR LADO 1CM



SIN GUÍA INFERIOR



ALTURA 195CM



APTO PARA ENCAJE +85€



ALTURA 150CM -15%€

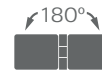

BISAGRA 180° OPCIONAL +140€



BISAGRAS FIJAS A PARED +70€

Indicar medida de los paneles fijos. | Indicar medida exacta del hueco. | Para mayor altura o anchura incremento de 30€ por cada 10cm.

*OPCIONAL 10MM: Incremento de 30% sobre PVP Cristal transparente de 6MM. | IVA no incluido. Montaje no incluido. Precios en €.

CASTOR 1 | OMIX 7

Angular de ducha o bañera. Dos fijos con perfiles de compensación y dos puertas de apertura exterior con cierre magnético en el vértice.



FICHA TÉCNICA



INSTRUCCIONES DE MONTAJE

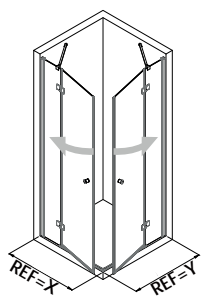

CASTOR 1 | OMIX 7. Cromo brillo.

REF.	Medidas en cm. X+Y	PVP Cristal transparente	Espesor
CASTOR 1			
2040	Hasta 180	1.000	6MM
2041	Hasta 210	1.050	6MM
2042	Hasta 240	1.100	6MM
OMIX 7			
1265	Hasta 180	1.246	8MM
1266	Hasta 210	1.332	8MM
1267	Hasta 240	1.419	8MM

+70€
PVP

SERIGRAFÍA 1

+100€
PVP

SERIGRAFÍA 2



Cromo brillo



Negro

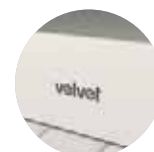

Blanco



FABRICACIÓN A MEDIDA



VIDRIO TEMPLADO 6MM o 8MM



VIDRIO TEMPLADO OPCIONAL 10MM*



TRATAMIENTO ANTICAL OPCIONAL +90€



CIERRE MAGNÉTICO



COMPENSACIÓN POR LADO 1CM



SIN GUÍA INFERIOR



ALTURA 195CM



APTO PARA ENCAJE +85€



ALTURA 150CM -15%€



BISAGRAS FIJAS A PARED +70€

Indicar medida de los paneles fijos. | Indicar medida y tipo de plato instalado (Elevado o a ras de suelo). | Para mayor altura o anchura incremento de 30€ por cada 10cm.

*OPCIONAL 10MM: Incremento de 30% sobre PVP Cristal transparente de 6MM. | IVA no incluido. Montaje no incluido. Precios en €.

CASTOR 6 | OMIX 6

Cabina de ducha o bañera. Un fijo con perfil de compensación y una puerta de apertura exterior con cierre magnético al fijo lateral.



FICHA TÉCNICA



INSTRUCCIONES DE MONTAJE

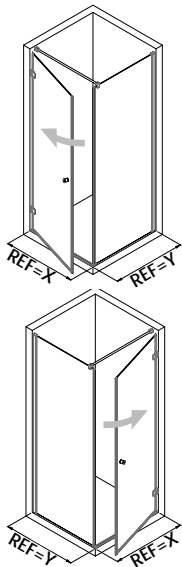

CASTOR 6 | OMIX 6. Cromo brillo. SERIGRAFÍA 2 A

ABATIBLES ABISAGRADAS

REF.	Medidas en cm. X+Y	PVP Cristal transparente	Espesor
CASTOR 6			
2151	Hasta 160	765	6MM
2152	Hasta 180	814	6MM
OMIX 6			
1275	Hasta 160	938	8MM
1276	Hasta 180	988	8MM

+50€ PVP

SERIGRAFÍA 1

+80€ PVP

SERIGRAFÍA 2



Cromo brillo



Negro



Blanco



FABRICACIÓN A MEDIDA



VIDRIO TEMPLADO 6MM o 8MM



VIDRIO TEMPLADO OPCIONAL 10MM*



TRATAMIENTO ANTICAL OPCIONAL +70€



CIERRE MAGNÉTICO



COMPENSACIÓN POR LADO 1CM



SIN GUÍA INFERIOR



ALTURA 195CM



APTO PARA ENCAJE +85€



ALTURA 150CM -15%€



BISAGRAS FIJAS A PARED +35€

Indicar lado de fijación de la puerta. | Indicar medida y tipo de plato instalado (Elevado o a ras de suelo). | Para mayor altura o anchura incremento de 30€ por cada 10cm.

*OPCIONAL 10MM: Incremento de 30% sobre PVP Cristal transparente de 6MM. | IVA no incluido. Montaje no incluido. Precios en €.

CASTOR 7 | OMIX 8

Cabina de ducha o bañera. Dos fijos con perfil de compensación y una puerta de apertura exterior y cierre magnético al fijo frontal.



FICHA TÉCNICA



INSTRUCCIONES DE MONTAJE

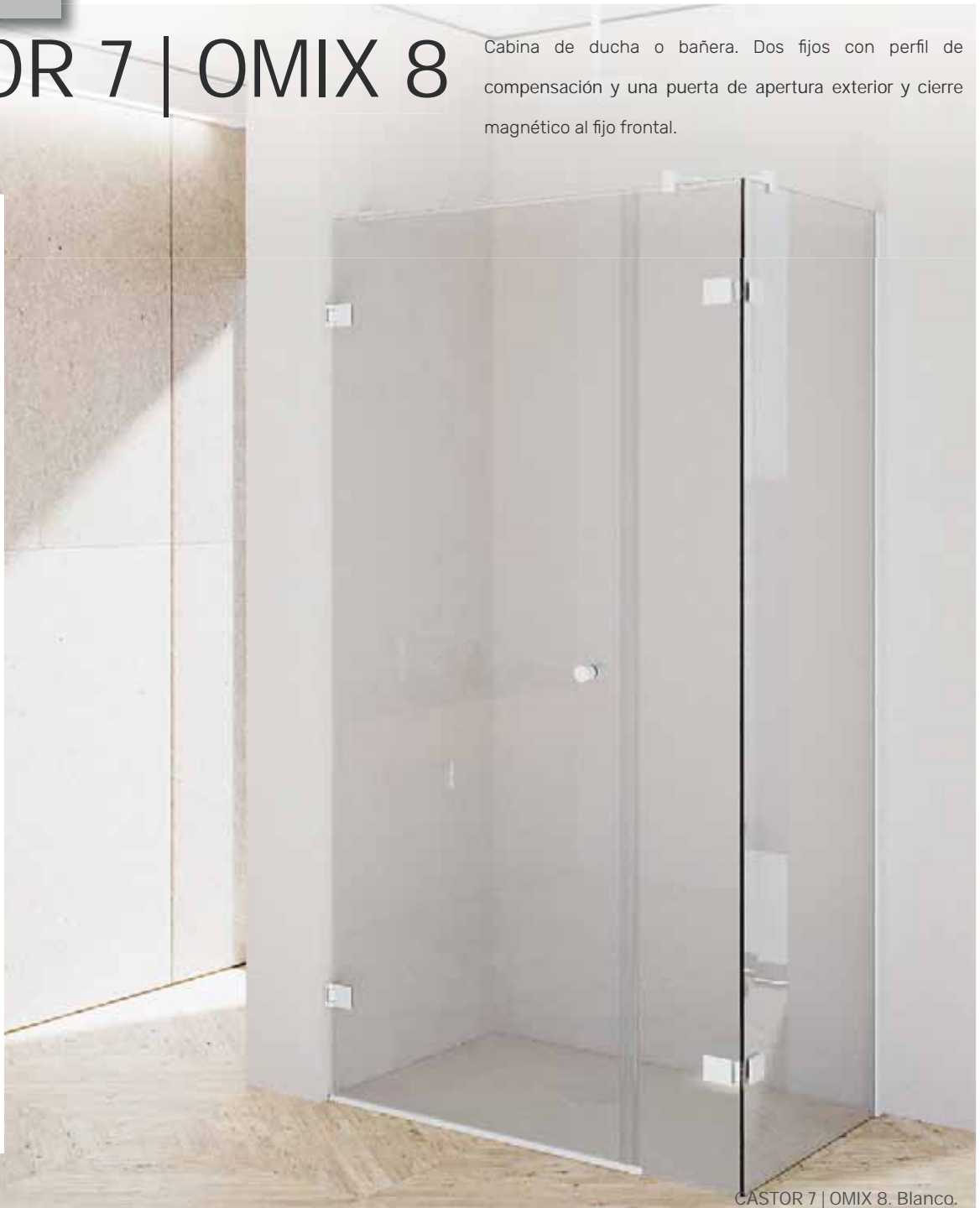
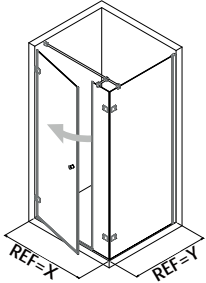
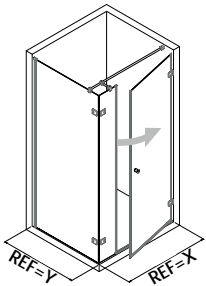

CASTOR 7 | OMIX 8. Blanco.

REF. Medidas en cm. X+Y PVP Cristal transparente Espesor

CASTOR 7

2375	Hasta 180	920	6MM
2376	Hasta 210	999	6MM
2377	Hasta 240	1.078	6MM

OMIX 8

1280	Hasta 180	1.122	8MM
1281	Hasta 210	1.209	8MM
1282	Hasta 240	1.296	8MM

+70€ PVP

SERIGRAFÍA 1

+100€ PVP

SERIGRAFÍA 2



Cromo brillo



Negro

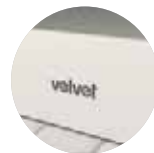

Blanco



FABRICACIÓN A MEDIDA



VIDRIO TEMPLADO 6MM O 8MM



VIDRIO TEMPLADO OPCIONAL 10MM*



TRATAMIENTO ANTICAL OPCIONAL +90€



CIERRE MAGNÉTICO



COMPENSACIÓN 1CM



SIN GUÍA INFERIOR



ALTURA 195CM



APTO PARA ENCAJE +85€



ALTURA 150CM -15%€



BISAGRAS FIJAS A PARED +35€

Indicar lado de fijación de la puerta y medida del panel fijo frontal. | Indicar medida y tipo de plato instalado (Elevado o a ras de suelo).

Para mayor altura o anchura incremento de 30€ por cada 10cm. | *OPCIONAL 10MM: Incremento de 30% sobre PVP Cristal transparente de 6MM.

IVA no incluido. Montaje no incluido. Precios en €.

FABRICANTES DE MAMPARAS, DESDE 1981.

CASTOR 9 | OMIX 5

Cabina de ducha o bañera. Dos fijos con perfiles de compensación y una puerta de apertura exterior y cierre magnético al fijo lateral.



FICHA TÉCNICA



INSTRUCCIONES DE MONTAJE

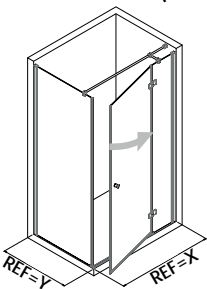
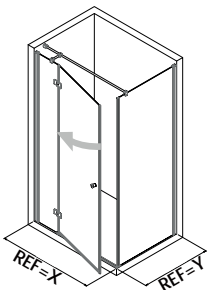

CASTOR 9 | OMIX 5. Negro. SERIGRAFÍA 2 G

ABATIBLES ABISAGRADAS

REF.	Medidas en cm. X+Y	PVP Cristal transparente	Espesor
CASTOR 9			
2480	Hasta 180	920	6MM
2481	Hasta 210	999	6MM
2482	Hasta 240	1.078	6MM
OMIX 5			
1270	Hasta 180	1.122	8MM
1271	Hasta 210	1.209	8MM
1272	Hasta 240	1.296	8MM



SERIGRAFÍA 1



SERIGRAFÍA 2



Cromo brillo



Negro

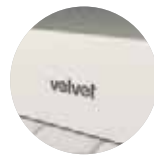

Blanco



FABRICACIÓN A MEDIDA



VIDRIO TEMPLADO 6MM O 8MM



VIDRIO TEMPLADO OPCIONAL 10MM*



TRATAMIENTO ANTICAL OPCIONAL +90€



CIERRE MAGNÉTICO



COMPENSACIÓN 1CM



SIN GUÍA INFERIOR



ALTURA 195CM



APTO PARA ENCAJE +85€



ALTURA 150CM -15%€



BISAGRAS FIJAS A PARED +70€

Indicar lado de fijación de la puerta y medida del panel fijo frontal. | Indicar medida y tipo de plato instalado (Elevado o a ras de suelo). Para mayor altura o anchura incremento de 30€ por cada 10cm. *OPCIONAL 10MM: Incremento de 30% sobre PVP Cristal transparente de 6MM. IVA no incluido. Montaje no incluido. Precios en €.

RORIS 1 | SETI 1

Frontal de ducha o bañera. Dos puertas plegables al interior.



FICHA TÉCNICA



INSTRUCCIONES DE MONTAJE

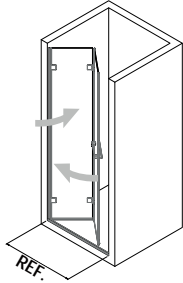
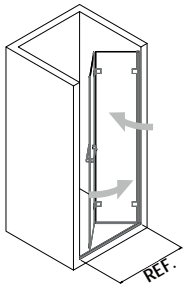

RORIS 1 | SETI 1. Cromo brillo.

REF.	Medidas en cm.	PVP Cristal transparente	Espesor
RORIS 1			
2030	Hasta 70	527	6MM
2031	Hasta 90	574	6MM
SETI 1			
1056	Hasta 70	685	8MM
1057	Hasta 90	746	8MM

+50€
PVP

SERIGRAFÍA 1

+80€
PVP

SERIGRAFÍA 2



Cromo brillo

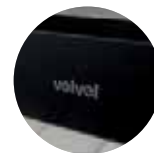

Negro

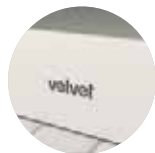

Blanco



FABRICACIÓN A MEDIDA



VIDRIO TEMPLADO 6MM O 8MM



VIDRIO TEMPLADO OPCIONAL 10MM*



TRATAMIENTO ANTICAL OPCIONAL +70€



SIN GUÍA INFERIOR



ALTURA 195CM



ALTURA 150CM -15%€



BISAGRAS FIJAS A PARED +35€

Indicar lado de fijación | Para una referencia más ancha, ver RORIS 3. | Para mayor altura incremento de 30€ por cada 10cm.

*OPCIONAL 10MM: Incremento de 30% sobre PVP Cristal transparente de 6MM. | IVA no incluido. Montaje no incluido. Precios en €.

RORIS 3 | SETI 3

Frontal de ducha o bañera. Un fijo con perfil de compensación y dos puertas plegables al interior.



FICHA TÉCNICA



INSTRUCCIONES DE MONTAJE

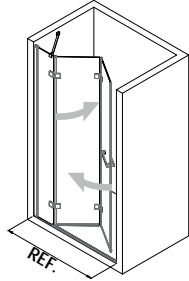
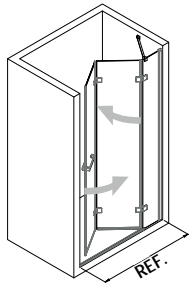

RORIS 3 | SETI 3. Negro.

ABATIBLES ABISAGRADAS

REF.	Medidas en cm.	PVP Cristal transparente	Espesor
RORIS 3			
2033	Hasta 100	674	6MM
2034	Hasta 120	723	6MM
2035	Hasta 140	772	6MM
SETI 3			
1260	Hasta 100	876	8MM
1261	Hasta 120	940	8MM
1262	Hasta 140	1.003	8MM

+70€
PVP

SERIGRAFÍA 1

+100€
PVP

SERIGRAFÍA 2



Cromo brillo



Negro



Blanco



FABRICACIÓN A MEDIDA



VIDRIO TEMPLADO 6MM O 8MM



VIDRIO TEMPLADO OPCIONAL 10MM*



TRATAMIENTO ANTICAL OPCIONAL +90€



COMPENSACIÓN 1CM



SIN GUÍA INFERIOR



ALTURA 195CM



APTO PARA ENCAJE +85€



ALTURA 150CM -15%€



BISAGRAS FIJAS A PARED +35€

Indicar lado de fijación de la puerta y medida del panel fijo frontal. | Para mayor altura o anchura incremento de 30€ por cada 10cm.

*OPCIONAL 10MM: Incremento de 30% sobre PVP Cristal transparente de 6MM. | IVA no incluido. Montaje no incluido. Precios en €.

RORIS 4 | SETI 4

Frontal de ducha o bañera. Un fijo con perfil de compensación y dos puertas plegables al interior con cierre magnético al fijo.



FICHA TÉCNICA



INSTRUCCIONES DE MONTAJE

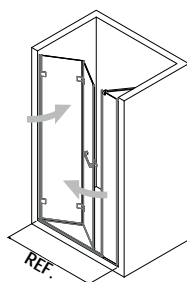
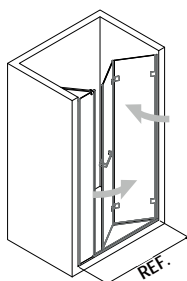

RORIS 4 | SETI 4. Negro.

REF.	Medidas en cm.	PVP Cristal transparente	Espesor
RORIS 4			
2080	Hasta 100	644	6MM
2081	Hasta 120	693	6MM
2082	Hasta 140	742	6MM
SETI 4			
1290	Hasta 100	837	8MM
1291	Hasta 120	900	8MM
1292	Hasta 140	964	8MM



SERIGRAFÍA 1



SERIGRAFÍA 2



Cromo brillo

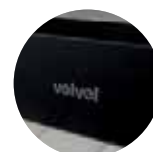

Negro

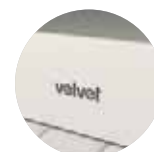

Blanco



FABRICACIÓN A MEDIDA



VIDRIO TEMPLADO 6MM O 8MM



VIDRIO TEMPLADO OPCIONAL 10MM*



TRATAMIENTO ANTICAL OPCIONAL +90€



CIERRE MAGNÉTICO



COMPENSACIÓN 1CM



SIN GUÍA INFERIOR



ALTURA 195CM



APTO PARA ENCAJE +85€



ALTURA 150CM -15%€



BISAGRAS FIJAS A PARED +35€

Indicar lado de fijación de la puerta y medida del panel fijo frontal. | Para mayor altura o anchura incremento de 30€ por cada 10cm.

*OPCIONAL 10MM: Incremento de 30% sobre PVP Cristal transparente de 6MM. | IVA no incluido. Montaje no incluido. Precios en €.

PANEL

Panel fijo para formar cabina con cualquier mampara de las series abisagradas:

CAPELA | MERIT, SINOPE | NELA, CASTOR | OMIX o RORIS | SETI.



FICHA
TÉCNICA



INSTRUCCIONES
DE MONTAJE

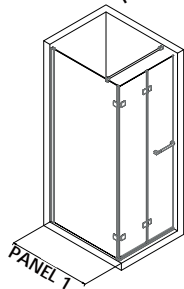
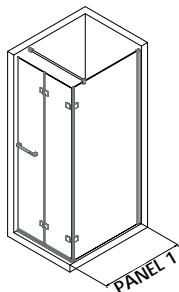

PANEL 1 + RORIS 3 | SETI 3. Cromo brillo.

ABATIBLES ABISAGRADAS

REF.	Medidas en cm.	PVP Cristal transparente	Espesor
PANEL 1	Hasta 40	275	6MM o 8MM
	Hasta 90	383	6MM o 8MM

INCLUYE TODOS LOS ELEMENTOS NECESARIOS PARA FORMAR CABINA*

+40€
PVP

SERIGRAFÍA 1

+70€
PVP

SERIGRAFÍA 2



Cromo brillo



Negro



Blanco



FABRICACIÓN
A MEDIDA



VIDRIO
TEMPLADO
6MM o 8MM



VIDRIO
TEMPLADO
10MM
+30%€**



TRATAMIENTO
ANTICAL
OPCIONAL
+35€



COMPENSACIÓN
1CM



SIN GUÍA
INFERIOR



ALTURA
195CM



APTO PARA
ENCAJE
+85€



ALTURA
150CM
-15%€



BISAGRAS
FIJAS
A PARED
+35€

*Perfilería, tensor, imán, etc. | Para mayor altura o anchura incremento de 30€ por cada 10cm.

**OPCIONAL 10MM: Incremento de 30% sobre PVP Cristal transparente de 6MM. | IVA no incluido. Montaje no incluido. Precios en €.



FABRICACIÓN
A MEDIDA

Serie ARIEL

Cabina semicircular para ducha de fabricación a medida. Vidrios templados de 6mm para las puertas abatibles y para los paneles fijos con perfiles de compensación. Sin guía inferior.



ARIEL 1. Negro.

ARIEL 1

Cabina semicircular de ducha. Dos fijos con perfiles de compensación y dos puertas de apertura exterior y cierre magnético en el centro.



FICHA
TÉCNICA



INSTRUCCIONES
DE MONTAJE



SERIGRAFÍAS
DISPONIBLES
SERIE ARIEL

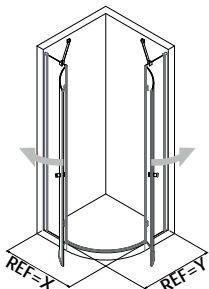

ARIEL 1. Cromo brillo.

ABATIBLES ABISAGRADAS

REF.	Medidas en cm. X	Medidas en cm. Y	PVP Cristal transparente
2049R	Hasta 90	Hasta 90	1.382
2049I	Hasta 90	Hasta 90	1.382
2500R	Hasta 100	Hasta 100	1.431
2500I	Hasta 100	Hasta 100	1.431

+70€
PVP

*SERIGRAFÍA 1



Cromo brillo



Negro

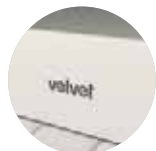

Blanco



FABRICACIÓN
A MEDIDA



VIDRIO
TEMPLADO
6MM



TRATAMIENTO
ANTICAL
OPCIONAL
+90€



CIERRE
MAGNÉTICO



COMPENSACIÓN
POR LADO
1CM



SIN GUÍA
INFERIOR



ALTURA
ÚNICA
195CM



APTO PARA
ENCAJE
+85€



BISAGRAS
FIJAS
A PARED
+70€

R: Plato radio ROCA 50cm. I: Plato radio IDEAL 55cm. | Indicar medida y tipo de plato instalado (Elevado o a ras de suelo). | Para mayor anchura incremento de 30€ por cada 10cm.

*Serigrafía 1: A, B, C, D, G, M, N y Q. | Altura única 195cm. | IVA no incluido. Montaje no incluido. Precios en €.

ABATIBLES ABISAGRADAS*

OTRAS COMPOSICIONES ESPECIALES

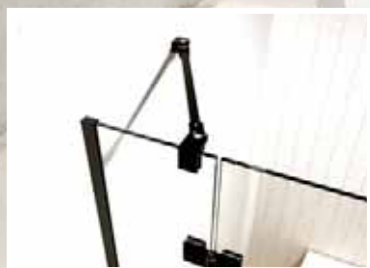

31034 TENSOR ARTICULADO. Ver página 150.

A. CAPELA 1 | MERIT 1 + SINOPE 1 | NELA 11. Negro. + NIDIA 3 OPCIÓN ENMARCADA.



B. CASTOR 7 | OMIK 8 CABINA ESPECIAL. Cromo brillo. + PANEL

*Consultar para cualquier composición especial.



C. SINOPE 5 | NELA 7 ESPECIAL. Cromo brillo. + PANEL + ENCAJE.

ABATIBLES ABISAGRADAS



D. CASTOR 9 | OMIX 5 BAÑERA. Negro + RORIS 1 | SETI 1 + PANEL. Negro + SERIGRAFÍA 2 G

*Consultar para cualquier composición especial.

Series CORA | POLUX | ICRA

Mamparas para ducha o bañera de fabricación a medida. Vidrio templado de 6mm para los fijos y para las puertas. Sin guía inferior y perfilaría lateral, otorgando versatilidad y adaptabilidad en todas las series.



Perfilería lateral con compensación.



Pomos y tiradores de alta calidad. Ver página 150.



[SERIGRAFÍAS
DISPONIBLES
SERIES CORA | POLUX | ICRA](#)



FABRICACIÓN
A MEDIDA

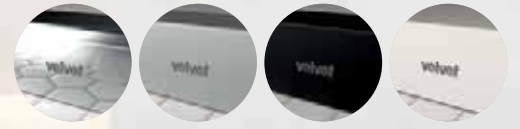

4 ACABADOS
SIN INCREMENTOS



ABATIBLES PERFILERIA LATERAL

ICRA 1. Negro.

CORA 1

Frontal de ducha o bañera. Una puerta abatible de apertura exterior y cierre magnético.



FICHA
TÉCNICA



INSTRUCCIONES
DE MONTAJE

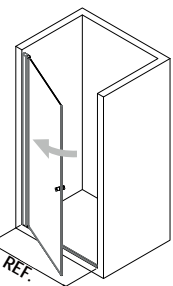
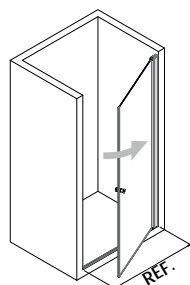

CORA 1. Cromo brillo.

REF.	Medidas en cm.	PVP Cristal transparente
100	Hasta 80	444
101	Hasta 100	494



SERIGRAFÍA 1



SERIGRAFÍA 2



Cromo brillo



Plata mate



Negro

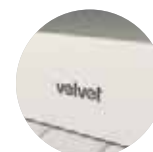

Blanco



FABRICACIÓN
A MEDIDA



VIDRIO
TEMPLADO
6MM



TRATAMIENTO
ANTICAL
OPCIONAL
+35€



CIERRE
MAGNÉTICO



COMPENSACIÓN
POR LADO
3CM



SIN GUÍA
INFERIOR



ALTURA
195CM



ALTURA
150CM
-15%€

Indicar lado de fijación. | Indicar medida exacta del hueco. | Para mayor altura o anchura incremento de 30€ por cada 10cm. | IVA no incluido. Montaje no incluido. Precios en €.

CORA 3

Frontal de ducha o bañera. Dos puertas abatibles de apertura 180° con cierre magnético en el centro.



FICHA TÉCNICA



INSTRUCCIONES DE MONTAJE

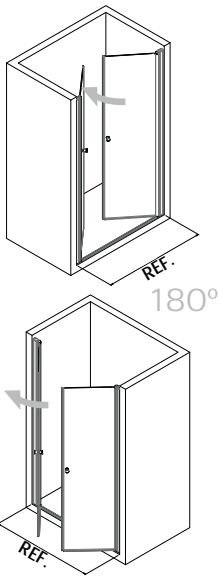

CORA 3. Cromo brillo.

ABATIBLES DE PERFILERÍA LATERAL

REF.	Medidas en cm.	PVP Cristal transparente
110	Hasta 100	549
111	Hasta 120	598
112	Hasta 140	647

+50€
PVP

SERIGRAFÍA 1

+80€
PVP

SERIGRAFÍA 2



Cromo brillo



Plata mate



Negro



Blanco



FABRICACIÓN A MEDIDA



VIDRIO TEMPLADO 6MM



TRATAMIENTO ANTICAL OPCIONAL +70€



CIERRE MAGNÉTICO



COMPENSACIÓN POR LADO 3CM



SIN GUÍA INFERIOR



ALTURA 195CM



ALTURA 150CM -15%€

Indicar medida exacta del hueco. | Para mayor altura o anchura incremento de 30€ por cada 10cm. | IVA no incluido. Montaje no incluido. Precios en €.

POLUX 1

Frontal de ducha o bañera. Un fijo y una puerta de apertura exterior con cierre magnético al fijo.



FICHA
TÉCNICA



INSTRUCCIONES
DE MONTAJE

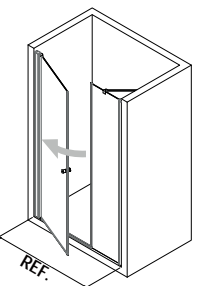
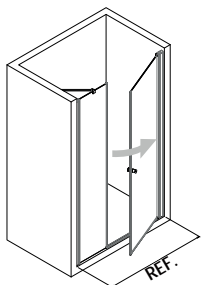

POLUX 1. Cromo brillo.

REF.	Medidas en cm.	PVP Cristal transparente
122	Hasta 100	545
123	Hasta 120	593
124	Hasta 140	643

+50€
PVP

SERIGRAFÍA 1

+80€
PVP

SERIGRAFÍA 2

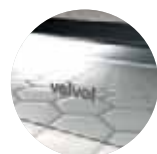

Cromo brillo

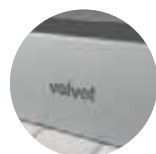

Plata mate

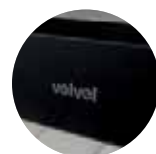

Negro

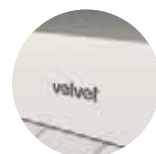

Blanco



FABRICACIÓN
A MEDIDA



VIDRIO
TEMPLADO
6MM



TRATAMIENTO
ANTICAL
OPCIONAL
+70€



CIERRE
MAGNÉTICO



COMPENSACIÓN
POR LADO
3CM



SIN GUÍA
INFERIOR



ALTURA
195CM



ALTURA
150CM
-15%€

Indicar lado de fijación de la puerta y medida del panel fijo frontal. | Indicar medida exacta del hueco. | Para mayor altura o anchura incremento de 30€ por cada 10cm.

IVA no incluido. Montaje no incluido. Precios en €.

POLUX 3

Frontal de ducha o bañera. Un fijo y una puerta abatible de apertura exterior con cierre magnético a la pared.



FICHA TÉCNICA



INSTRUCCIONES DE MONTAJE

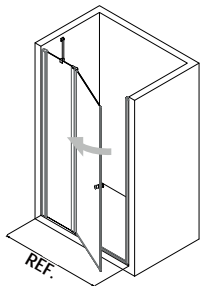

REF.

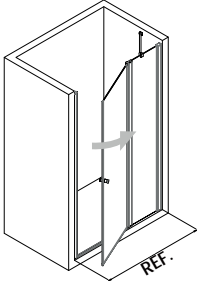

REF.

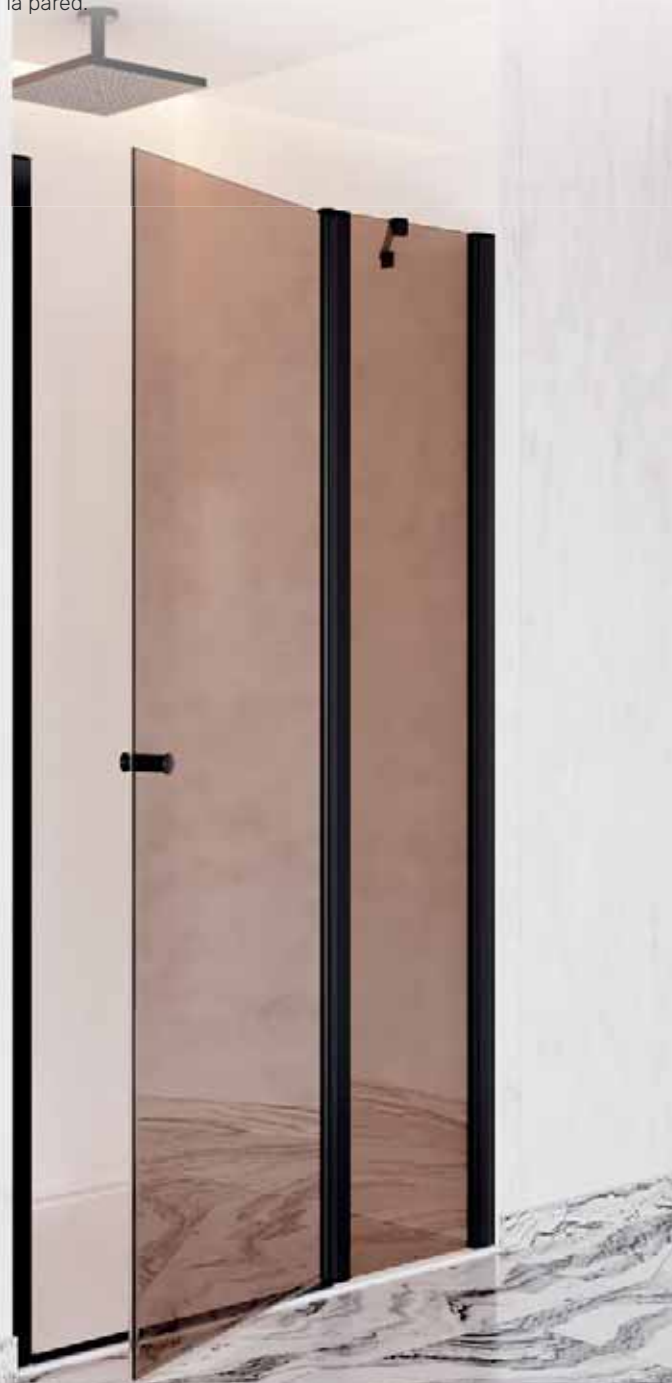

POLUX 3. Negro. SERIGRAFÍA 2 H

ABATIBLES DE PERFILERÍA LATERAL

REF.	Medidas en cm.	PVP Cristal transparente
132	Hasta 100	555
133	Hasta 120	606
134	Hasta 140	654

+50€
PVP

SERIGRAFÍA 1

+80€
PVP

SERIGRAFÍA 2



Cromo brillo



Plata mate



Negro

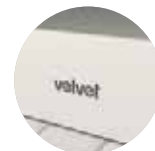

Blanco



FABRICACIÓN A MEDIDA



VIDRIO TEMPLADO 6MM



TRATAMIENTO ANTICAL OPCIONAL +70€



CIERRE MAGNÉTICO



COMPENSACIÓN POR LADO 3CM



SIN GUÍA INFERIOR



ALTURA 195CM



ALTURA 150CM -15%€

Indicar lado de fijación de la puerta y medida del panel fijo frontal. | Indicar medida exacta del hueco. | Para mayor altura o anchura incremento de 30€ por cada 10cm.

IVA no incluido. Montaje no incluido. Precios en €.

ICRA 1

Frontal de ducha o bañera. Dos puertas plegables de apertura interior y cierre magnético.



FICHA
TÉCNICA



INSTRUCCIONES
DE MONTAJE

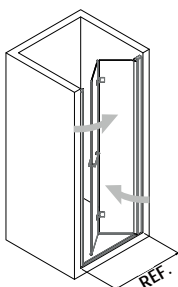

REF.

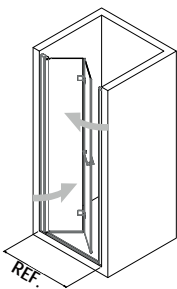

REF.



ICRA 1. Cromo brillo

REF.	Medidas en cm.	PVP Cristal transparente
104	Hasta 80	554
105	Hasta 100	603

+50€
PVP

SERIGRAFÍA 1

+80€
PVP

SERIGRAFÍA 2

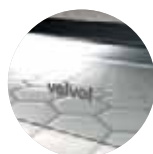

Cromo brillo



*Plata mate



Negro

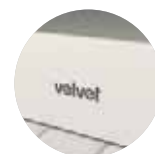

Blanco



FABRICACIÓN
A MEDIDA



VIDRIO
TEMPLADO
6MM



TRATAMIENTO
ANTICAL
OPCIONAL
+70€



CIERRE
MAGNÉTICO



COMPENSACIÓN
POR LADO
3CM



SIN GUÍA
INFERIOR



ALTURA
195CM



ALTURA
150CM
-15%€

Indicar lado de la fijación | Indicar medida exacta del hueco. | Para mayor altura o anchura incremento de 30€ por cada 10cm.

*Bisagras y tirador en Cromo brillo. | IVA no incluido. Montaje no incluido. Precios en €.

PANEL CORA 2

Panel fijo para formar cabina con las mamparas de las series CORA, POLUX o ICRA.



FICHA
TÉCNICA



INSTRUCCIONES
DE MONTAJE

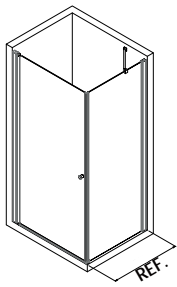

CORA 1 + PANEL CORA 2. Cromo brillo.

ABATIBLES DE PERFILERÍA LATERAL

REF.	Medidas en cm.	PVP Cristal transparente
160L	Hasta 80	273
161L	Hasta 100	317

+40€
PVP

SERIGRAFÍA 1

+70€
PVP

SERIGRAFÍA 2

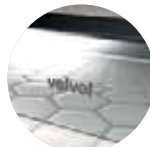

Cromo brillo



Plata mate



Negro



Blanco



FABRICACIÓN
A MEDIDA



VIDRIO
TEMPLADO
6MM



TRATAMIENTO
ANTICAL
OPCIONAL
+35€



CIERRE
MAGNÉTICO



COMPENSACIÓN
3CM



SIN GUÍA
INFERIOR



ALTURA
195CM



ALTURA
150CM
-15%€

Para mayor altura o anchura incremento de 30€ por cada 10cm. | Barra soporte incluida en el precio, para cambio a soporte 45° incremento de 40€.

IVA no incluido. Montaje no incluido. Precios en €.



FABRICACIÓN
A MEDIDA

Serie ORBIT



[DETALLE
PLACA ACRÍLICA
'AQUA'](#)

Mamparas para ducha o bañera de fabricación a medida. Cierre magnético, guía inferior y perfiles con compensación. Diferentes opciones de configuración, ya sea vidrio templado o placas acrílicas "Aqua", tres puertas correderas con apertura hacia ambos lados.



Compensación de 2,5cm por lado.



Tres puertas correderas con apertura bidireccional.



[SERIGRAFÍAS
DISPONIBLES
SERIE ORBIT](#)



ACRÍLICAS OPCIÓN CRISTAL

ORBIT 1

Frontal de ducha o bañera. Tres puertas correderas de apertura bidireccional y cierre magnético.



FICHA
TÉCNICA



INSTRUCCIONES
DE MONTAJE

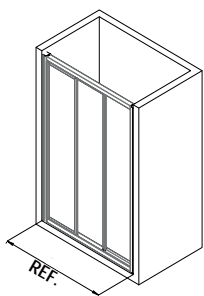

ORBIT 1. Blanco. PLACA ACRÍLICA "AQUA"

REF.	Medidas en cm.	PVP Placa acrílica	PVP Cristal transparente
1600	Hasta 100	442	497
1605	Hasta 140	503	559
1610	Hasta 180	565	620



SERIGRAFÍA 1



SERIGRAFÍA 2

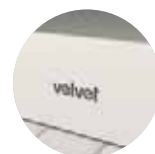

Blanco



FABRICACIÓN
A MEDIDA



VIDRIO
TEMPLADO
4MM



PLACA
ACRÍLICA
2,4MM



TRATAMIENTO
ANTICORROSIÓN
OPCIONAL
+90€



CIERRE
MAGNÉTICO



COMPENSACIÓN
POR LADO
2,5CM



CON GUÍA
INFERIOR



ALTURA
195CM



ALTURA
150CM
-20%€

Indicar medida exacta del hueco. | Para mayor altura o anchura incremento de 30€ por cada 10cm. | IVA no incluido. Montaje no incluido. Precios en €.

PANEL 3L

Panel fijo para formar cabina de ducha o bañera con ORBIT 1.



FICHA
TÉCNICA



INSTRUCCIONES
DE MONTAJE

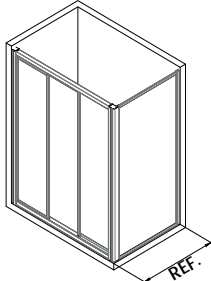

ORBIT 1 + PANEL 3L. Blanco.

REF.	Medidas en cm.	PVP Placa acrílica	PVP Cristal transparente
601	Hasta 40	169	226
602	Hasta 80	203	260
603	Hasta 100	232	289

+40€
PVP

SERIGRAFÍA 1

+70€
PVP

SERIGRAFÍA 2

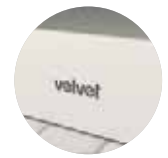

Blanco



FABRICACIÓN
A MEDIDA



VIDRIO
TEMPLADO
4MM



PLACA
ACRÍLICA
2,4MM



TRATAMIENTO
ANTICAL
OPCIONAL
+35€



COMPENSACIÓN
POR LADO
2,5CM



CON GUÍA
INFERIOR



ALTURA
195CM



ALTURA
150CM
-20%€

Para mayor altura o anchura incremento de 30€ por cada 10cm. | IVA no incluido. Montaje no incluido. Precios en €.

Serie URANIA



[DETALLE
PLACA ACRÍLICA
"AQUA"](#)

Mamparas para ducha o bañera de fabricación a medida. Cierre magnético, guía inferior y perfiles de expansión en toda la serie. Dispone de diferentes opciones de configuración, ya sea vidrio templado o placas acrílicas "Aqua", puertas correderas o puertas pivotantes.



Compensación de 2cm por lado.



Serie con guía inferior, mayor robustez.



[SERIGRAFÍAS
DISPONIBLES
SERIE URANIA](#)

Para otras composiciones especiales de URANIA, ver la página 135.



FABRICACIÓN
A MEDIDA

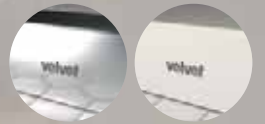

2 ACABADOS
SIN INCREMENTOS



URANIA 6. Plata brillo.

URANIA 1

Angular de ducha o bañera. Dos fijos y dos puertas correderas con cierre magnético en el vértice.



FICHA TÉCNICA



INSTRUCCIONES DE MONTAJE

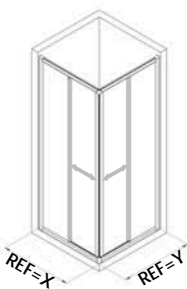

URANIA 1. Plata brillo.

REF.	Medidas en cm. X+Y	PVP Placa acrílica	PVP Cristal transparente
209	Hasta 180	421	476
210	Hasta 210	483	538
211	Hasta 240	545	599



SERIGRAFÍA 1



SERIGRAFÍA 2

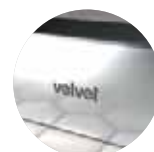

Plata brillo

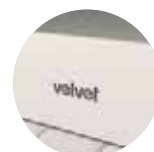

Blanco



FABRICACIÓN A MEDIDA



VIDRIO TEMPLADO 4MM



PLACA ACRÍLICA 2,4MM



TRATAMIENTO ANTICAL OPCIONAL +90€



CIERRE MAGNÉTICO



COMPENSACIÓN POR LADO 2CM



CON GUÍA INFERIOR



ALTURA 195CM



ALTURA 150CM -20%€

Indicar lado derecho/izquierdo. | Indicar medida y tipo de plato instalado (Elevado o a ras de suelo). | Para mayor altura o anchura incremento de 30€ por cada 10cm.

IVA no incluido. Montaje no incluido. Precios en €.

URANIA 3

Cabina semicircular para ducha. Dos fijos y dos puertas correderas con cierre magnético en el centro.



FICHA TÉCNICA



INSTRUCCIONES DE MONTAJE

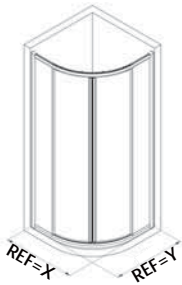

URANIA 3. Blanco.

REF.	Radio	Medidas en cm. X	Medidas en cm. Y	PVP Placa acrílica	PVP Cristal transparente
227	37,5	Hasta 75	Hasta 75	530	611
228	50/55	Hasta 80	Hasta 80	555	636
229	50/55	Hasta 100	Hasta 100	580	660



*SERIGRAFÍA 1



Plata brillo

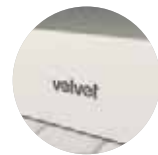

Blanco



FABRICACIÓN A MEDIDA



VIDRIO TEMPLADO 4MM



PLACA ACRÍLICA 2,4MM



TRATAMIENTO ANTICAL OPCIONAL +90€



CIERRE MAGNÉTICO



COMPENSACIÓN POR LADO 2CM



CON GUÍA INFERIOR



ALTURA ÚNICA 195CM

R: Plato radio ROCA 50cm. I: Plato radio IDEAL 55cm. | Indicar medida y tipo de plato instalado (Elevado o a ras de suelo). | Para mayor anchura incremento de 30€ por cada 10cm.

*Serigrafía 1: A, B, C, D, G, M, N y Q. | Altura única 195cm. | IVA no incluido. Montaje no incluido. Precios en €.

URANIA 4

Frontal de ducha o bañera. Un fijo y dos puertas correderas con cierre magnético.



FICHA TÉCNICA



INSTRUCCIONES DE MONTAJE

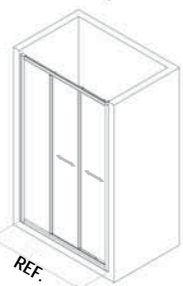

URANIA 4. Plata brillo.

REF.	Medidas en cm.	PVP Placa acrílica	PVP Cristal transparente
285	Hasta 100	396	451
286	Hasta 140	457	513
287	Hasta 180	519	574



SERIGRAFÍA 1



SERIGRAFÍA 2

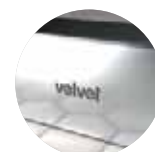

Plata brillo

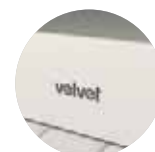

Blanco



FABRICACIÓN A MEDIDA



VIDRIO TEMPLADO 4MM

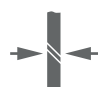

PLACA ACRÍLICA 2,4MM



TRATAMIENTO ANTICAL OPCIONAL +90€



CIERRE MAGNÉTICO



COMPENSACIÓN POR LADO 2CM



CON GUÍA INFERIOR



ALTURA 195CM



ALTURA 150CM -20%€

Indicar lado del fijo. | Indicar medida exacta del hueco. | Para mayor altura o anchura incremento de 30€ por cada 10cm. | IVA no incluido. Montaje no incluido. Precios en €.

URANIA 5

Frontal de ducha o bañera. Un fijo y una puerta corredera con cierre magnético.



FICHA
TÉCNICA



INSTRUCCIONES
DE MONTAJE

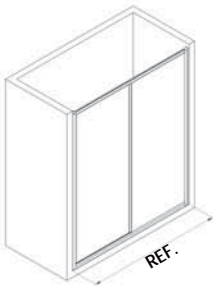

REF.

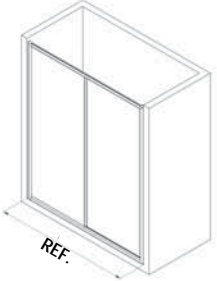

REF.



URANIA 5. Plata brillo.

REF.	Medidas en cm.	PVP Placa acrílica	PVP Cristal transparente
220	Hasta 100	382	437
221	Hasta 140	444	499
222	Hasta 180	505	562



SERIGRAFÍA 1



SERIGRAFÍA 2

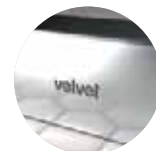

Plata brillo

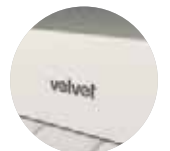

Blanco



FABRICACIÓN
A MEDIDA



VIDRIO
TEMPLADO
4MM



PLACA
ACRÍLICA
2,4MM



TRATAMIENTO
ANTICAL
OPCIONAL
+70€



CIERRE
MAGNÉTICO



COMPENSACIÓN
POR LADO
2CM



CON GUÍA
INFERIOR



ALTURA
195CM



ALTURA
150CM
-20%€

Indicar lado del fijo. | Indicar medida exacta del hueco. | Para mayor altura o anchura incremento de 30€ por cada 10cm. | IVA no incluido. Montaje no incluido. Precios en €.

URANIA 6

Frontal de ducha o bañera. Dos fijos y dos puertas correderas con cierre magnético en el centro.



FICHA TÉCNICA



INSTRUCCIONES DE MONTAJE

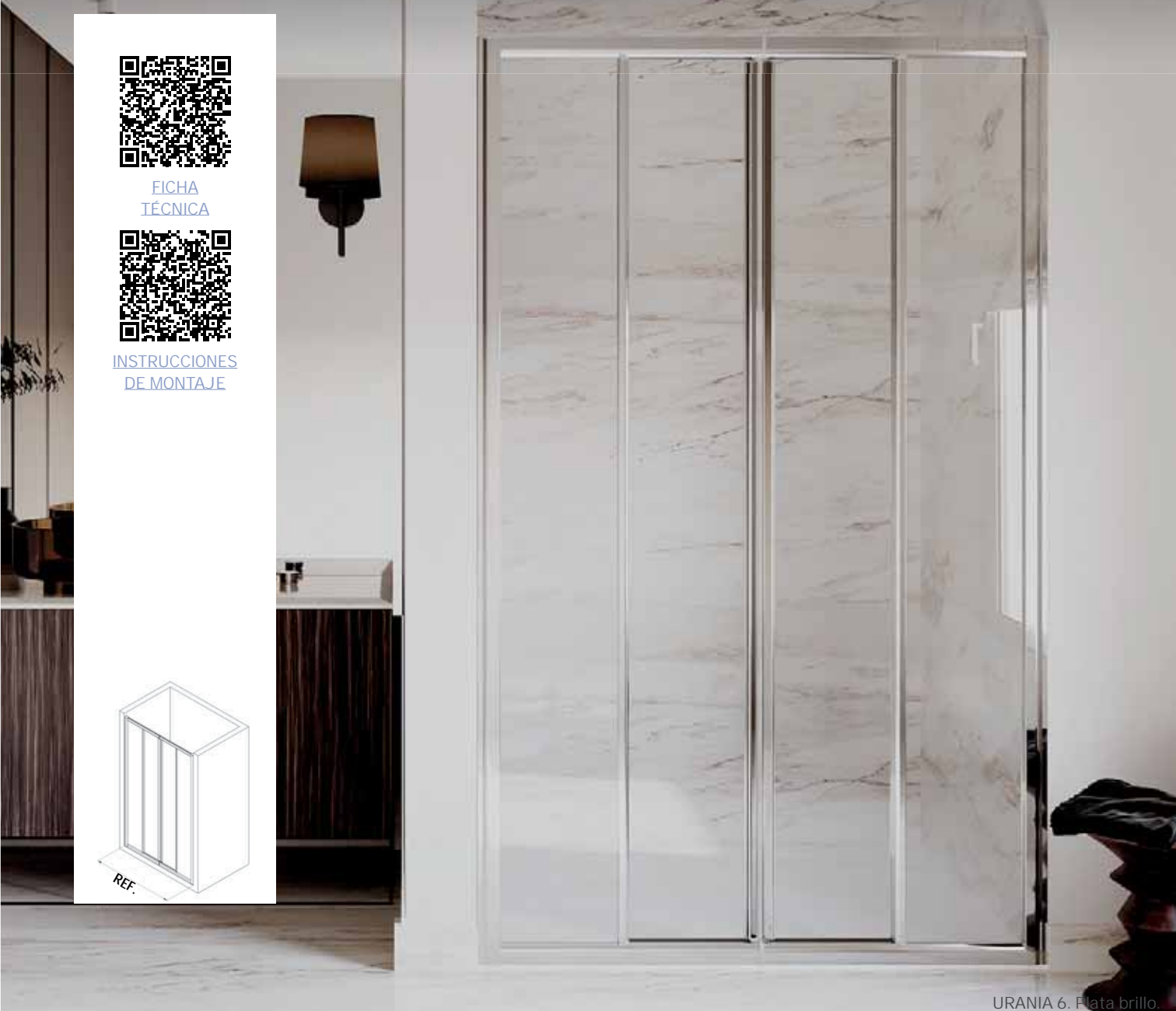

URANIA 6. Plata brillo.

REF.	Medidas en cm.	PVP Placa acrílica	PVP Cristal transparente
250	Hasta 120	505	562
251	Hasta 150	567	623
252	Hasta 180	629	685



SERIGRAFÍA 1



SERIGRAFÍA 2

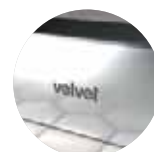

Plata brillo

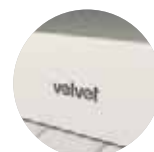

Blanco



FABRICACIÓN A MEDIDA



VIDRIO TEMPLADO 4MM



PLACA ACRÍLICA 2,4MM



TRATAMIENTO ANTICAL OPCIONAL +90€



CIERRE MAGNÉTICO



COMPENSACIÓN POR LADO 2CM



CON GUÍA INFERIOR



ALTURA 195CM



ALTURA 150CM -20%€

Indicar medida exacta del hueco. | Para mayor altura o anchura incremento de 30€ por cada 10cm. | IVA no incluido. Montaje no incluido. Precios en €.

URANIA 7

Frontal de ducha o bañera. Una puerta pivotante de apertura exterior y cierre magnético.



FICHA TÉCNICA



INSTRUCCIONES DE MONTAJE

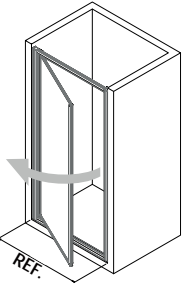
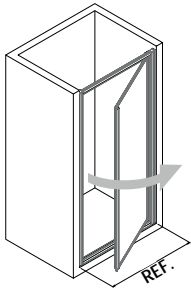

URANIA 7. Plata brillo. SERIGRAFÍA 1 A

REF.	Medidas en cm.	PVP Placa acrílica	PVP Cristal transparente
275	Hasta 80	346	401
276	Hasta 100	407	463



SERIGRAFÍA 1



SERIGRAFÍA 2



Plata brillo

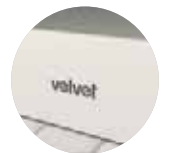

Blanco



FABRICACIÓN A MEDIDA



VIDRIO TEMPLADO 4MM



PLACA ACRÍLICA 2,4MM



TRATAMIENTO ANTICAL OPCIONAL +90€



CIERRE MAGNÉTICO



COMPENSACIÓN POR LADO 2CM



CON GUÍA INFERIOR



ALTURA 195CM



ALTURA 150CM -20%€

Indicar medida exacta del hueco. | Para mayor altura o anchura incremento de 30€ por cada 10cm. | IVA no incluido. Montaje no incluido. Precios en €.

URANIA 8

Frontal de ducha o bañera. Dos puertas pivotantes de apertura exterior y cierre magnético en el centro.



FICHA TÉCNICA



INSTRUCCIONES DE MONTAJE

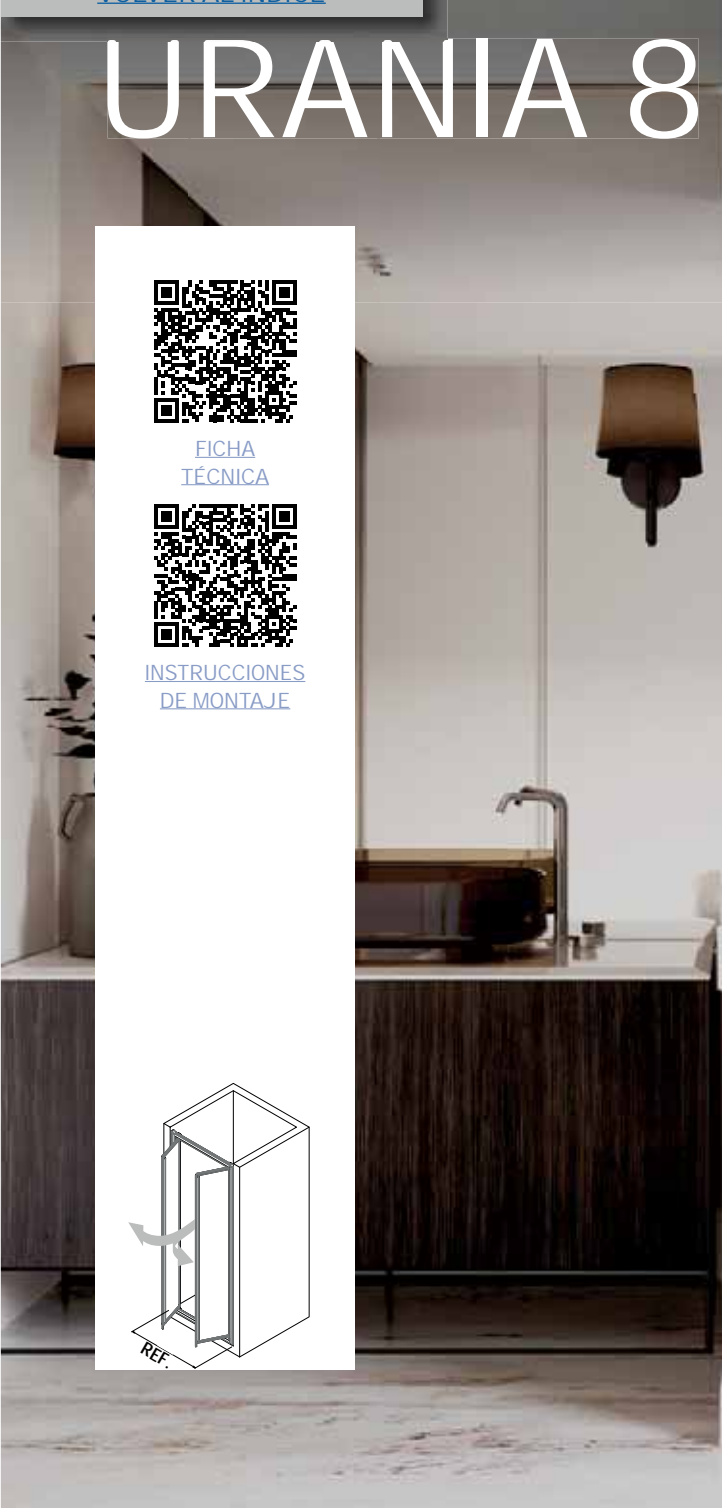
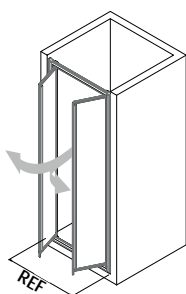

URANIA 8. Blanco.

REF.	Medidas en cm.	PVP Placa acrílica	PVP Cristal transparente
265	Hasta 80	371	426
266	Hasta 100	432	488
267	Hasta 120	494	549

+50€
PVP

SERIGRAFÍA 1

+80€
PVP

SERIGRAFÍA 2

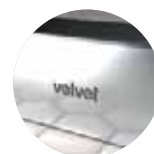

Plata brillo

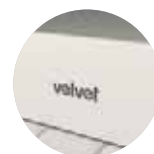

Blanco



FABRICACIÓN A MEDIDA



VIDRIO TEMPLADO 4MM



PLACA ACRÍLICA 2,4MM



TRATAMIENTO ANTICAL OPCIONAL +70€



CIERRE MAGNÉTICO



COMPENSACIÓN POR LADO 2CM



CON GUÍA INFERIOR



ALTURA 195CM



ALTURA 150CM -20%€

Indicar medida exacta del hueco. | Para mayor altura o anchura incremento de 30€ por cada 10cm. | IVA no incluido. Montaje no incluido. Precios en €.

URANIA 9

Angular de ducha o bañera. Dos fijos y cuatro puertas correderas con cierre magnético en el vértice.



FICHA TÉCNICA



INSTRUCCIONES DE MONTAJE

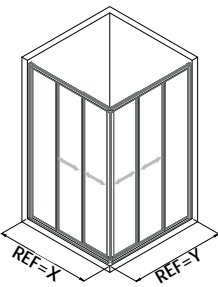

URANIA 9-Plata brillo.

REF.	Medidas en cm. X+Y	PVP Placa acrílica	PVP Cristal transparente
300	Hasta 180	606	660
301	Hasta 210	667	721
302	Hasta 240	729	783

+70€
PVP

SERIGRAFÍA 1

+100€
PVP

SERIGRAFÍA 2



Plata brillo

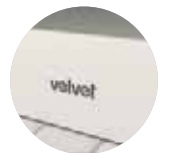

Blanco



FABRICACIÓN A MEDIDA



VIDRIO TEMPLADO 4MM



PLACA ACRÍLICA 2,4MM



TRATAMIENTO ANTIRRUSTO OPCIONAL +90€



CIERRE MAGNÉTICO



COMPENSACIÓN POR LADO 2CM



CON GUÍA INFERIOR



ALTURA 195CM



ALTURA 150CM -20%€

Indicar lado derecho/izquierdo. | Indicar medida y tipo de plato instalado (Elevado o a ras de suelo). | Para mayor altura o anchura incremento de 30€ por cada 10cm.

IVA no incluido. Montaje no incluido. Precios en €.

URANIA 10

Angular de ducha o bañera. Dos fijos y tres puertas correderas con cierre magnético en el vértice.



FICHA TÉCNICA



INSTRUCCIONES DE MONTAJE

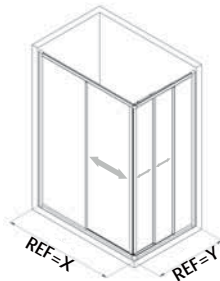
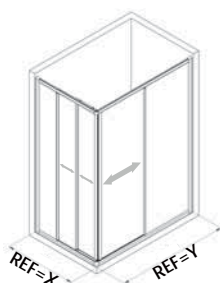

URANIA.10. Plata brillo.

REF.	Medidas en cm. X+Y	PVP Placa acrílica	PVP Cristal transparente
303	Hasta 180	514	568
304	Hasta 210	575	630
305	Hasta 240	637	691



SERIGRAFÍA 1



SERIGRAFÍA 2

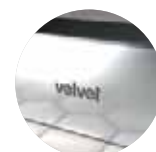

Plata brillo

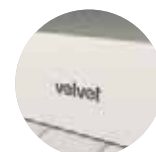

Blanco



FABRICACIÓN A MEDIDA



VIDRIO TEMPLADO 4MM



PLACA ACRÍLICA 2,4MM



TRATAMIENTO ANTICAL OPCIONAL +90€



CIERRE MAGNÉTICO



COMPENSACIÓN POR LADO 2CM



CON GUÍA INFERIOR



ALTURA 195CM



ALTURA 150CM -20%€

Indicar lado derecho/izquierdo: 1 o 2 puertas. | Indicar medida y tipo de plato instalado (Elevado o a ras de suelo).

Para mayor altura o anchura incremento de 30€ por cada 10cm. | IVA no incluido. Montaje no incluido. Precios en €.

URANIA | OTRAS COMPOSICIONES ESPECIALES*



URANIA 5 BAÑERA. Plata brillo. + [PANEL 4L](#) (Ver página 141).



ACRÍLICAS OPCIÓN CRISTAL

URANIA 6 BAÑERA. + [PANEL 4L](#). + NISTE 1. Blanco.

*Consultar para cualquier composición especial.

Series NISTE | MIX

Mamparas para ducha o bañera de fabricación a medida. Cierre magnético, guía inferior y perfiles de expansión en las dos series. Dispone de diferentes opciones de configuración, ya sea vidrio templado o placas acrílicas "Aqua", puertas plegables, puertas correderas o combinando ambas.



Compensación de 2cm por lado.



Serie con puertas plegables, mayor acceso.



[SERIGRAFÍAS
DISPONIBLES
SERIE NISTE | MIX](#)



DETALLE
PLACA ACRÍLICA
"AQUA"



FABRICACIÓN
A MEDIDA

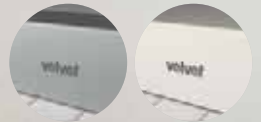

2 ACABADOS
SIN INCREMENTOS



NISTE 2. Blanco.

NISTE 1

Frontal de ducha o bañera. Dos puertas plegables al interior con cierre magnético.



FICHA
TÉCNICA



INSTRUCCIONES
DE MONTAJE

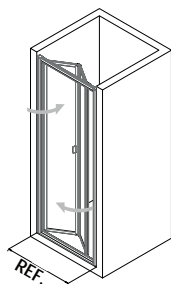
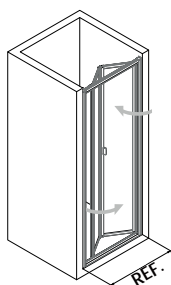

NISTE 1. Blanco.

REF.	Medidas en cm.	PVP Placa acrílica	PVP Cristal transparente
245	Hasta 80	410	463
246	Hasta 100*	470	524

+50€
PVP

SERIGRAFÍA 1

+80€
PVP

SERIGRAFÍA 2



Plata mate



Blanco



FABRICACIÓN
A MEDIDA



VIDRIO
TEMPLADO
4MM



PLACA
ACRÍLICA
2,4MM



TRATAMIENTO
ANTICAL
OPCIONAL
+70€



CIERRE
MAGNÉTICO



COMPENSACIÓN
POR LADO
2CM



CON GUÍA
INFERIOR



ALTURA
195CM



ALTURA
150CM
-20%€

Indicar lado de la fijación. | Indicar medida exacta del hueco. | Para mayor altura o anchura incremento de 30€ por cada 10cm.

*Anchura máxima en placa acrílica: 120cm. - Anchura máxima en cristal transparente: 100cm | IVA no incluido. Montaje no incluido. Precios en €.

NISTE 2

Frontal de ducha o bañera. Cuatro puertas plegables al interior con cierre magnético en el centro.



FICHA
TÉCNICA



INSTRUCCIONES
DE MONTAJE

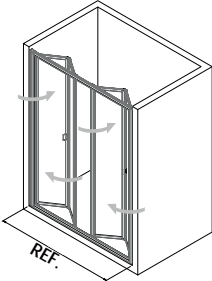

NISTE 2. Plata brillo.

REF.	Medidas en cm.	PVP Placa acrílica	PVP Cristal transparente
364	Hasta 120	564	619
365	Hasta 150	625	679
366	Hasta 180	685	739

+70€
PVP

SERIGRAFÍA 1

+100€
PVP

SERIGRAFÍA 2



Plata mate

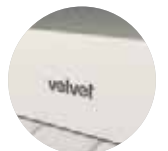

Blanco



FABRICACIÓN
A MEDIDA



VIDRIO
TEMPLADO
4MM



PLACA
ACRÍLICA
2,4MM



TRATAMIENTO
ANTIRRUSTO
OPCIONAL
+90€



CIERRE
MAGNÉTICO



COMPENSACIÓN
POR LADO
2CM



CON GUÍA
INFERIOR



ALTURA
195CM



ALTURA
150CM
-20%€

ACRÍLICAS OPCIÓN CRISTAL

Indicar medida exacta del hueco. | Para mayor altura o anchura incremento de 30€ por cada 10cm. | IVA no incluido. Montaje no incluido. Precios en €.

MIX 1

Angular de ducha o bañera. Un fijo con una puerta corredera y dos puertas plegables al interior y cierre magnético en el vértice.



FICHA TÉCNICA



INSTRUCCIONES DE MONTAJE

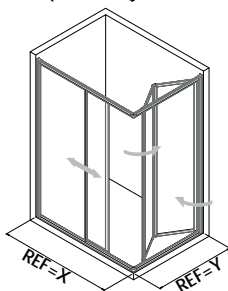
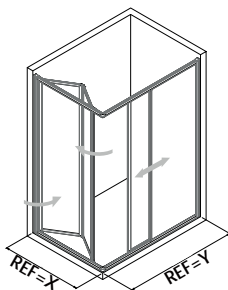

MIX 1. Plata mate.

REF.	Medidas en cm. X+Y	PVP Placa acrílica	PVP Cristal transparente
270	Hasta 180	590	642
271	Hasta 210	649	702
272	Hasta 240	710	762

+70€
PVP

SERIGRAFÍA 1

+100€
PVP

SERIGRAFÍA 2



Plata mate

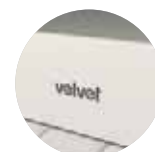

Blanco



FABRICACIÓN A MEDIDA



VIDRIO TEMPLADO 4MM



PLACA ACRÍLICA 2,4MM



TRATAMIENTO ANTICAL OPCIONAL +90€



CIERRE MAGNÉTICO



COMPENSACIÓN POR LADO 2CM



CON GUÍA INFERIOR



ALTURA 195CM



ALTURA 150CM -20%€

Indicar lado izquierdo/derecho: corredera o plegable. | Indicar medida y tipo de plato instalado (Elevado o a ras de suelo).

Para mayor altura o anchura incremento de 30€ por cada 10cm. | IVA no incluido. Montaje no incluido. Precios en €.

PANEL 4L

Panel fijo para formar cabina de ducha o bañera con cualquier modelo de las series URANIA, NISTE o MIX.



FICHA
TÉCNICA



INSTRUCCIONES
DE MONTAJE

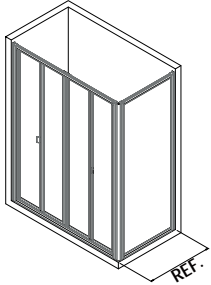

PANEL 4L + NISTE 2. Plata mate.

REF.	Medidas en cm.	PVP Placa acrílica	PVP Cristal transparente
280L	Hasta 40	169	226
281L	Hasta 80	203	260
282L	Hasta 100	232	289

+40€
PVP

SERIGRAFÍA 1

+70€
PVP

SERIGRAFÍA 2



Plata brillo



Plata mate



Blanco



FABRICACIÓN
A MEDIDA



VIDRIO
TEMPLADO
4MM



PLACA
ACRÍLICA
2,4MM



TRATAMIENTO
ANTICAL
OPCIONAL
+35€



COMPENSACIÓN
POR LADO
2CM



ALTURA
195CM



ALTURA
150CM
-20%€

Para mayor altura o anchura incremento de 30€ por cada 10cm. | ACABADOS PARA URANIA: Plata brillo y Blanco. | ACABADOS PARA NISTE Y MIX: Plata mate y Blanco.
IVA no incluido. Montaje no incluido. Precios en €.



FABRICACIÓN
A MEDIDA

Serie VELA

Puertas de paso de fabricación a medida. Vidrio templado de 8mm para los fijos y las puertas correderas. Sin guía inferior.



Vista sección de la guía.



Tiradores premium XENIA 42. Ver página 150.



SERIGRAFÍAS
DISPONIBLES
SERIE VELA

[Para otras composiciones especiales de VELA, ver la página 149.](#)

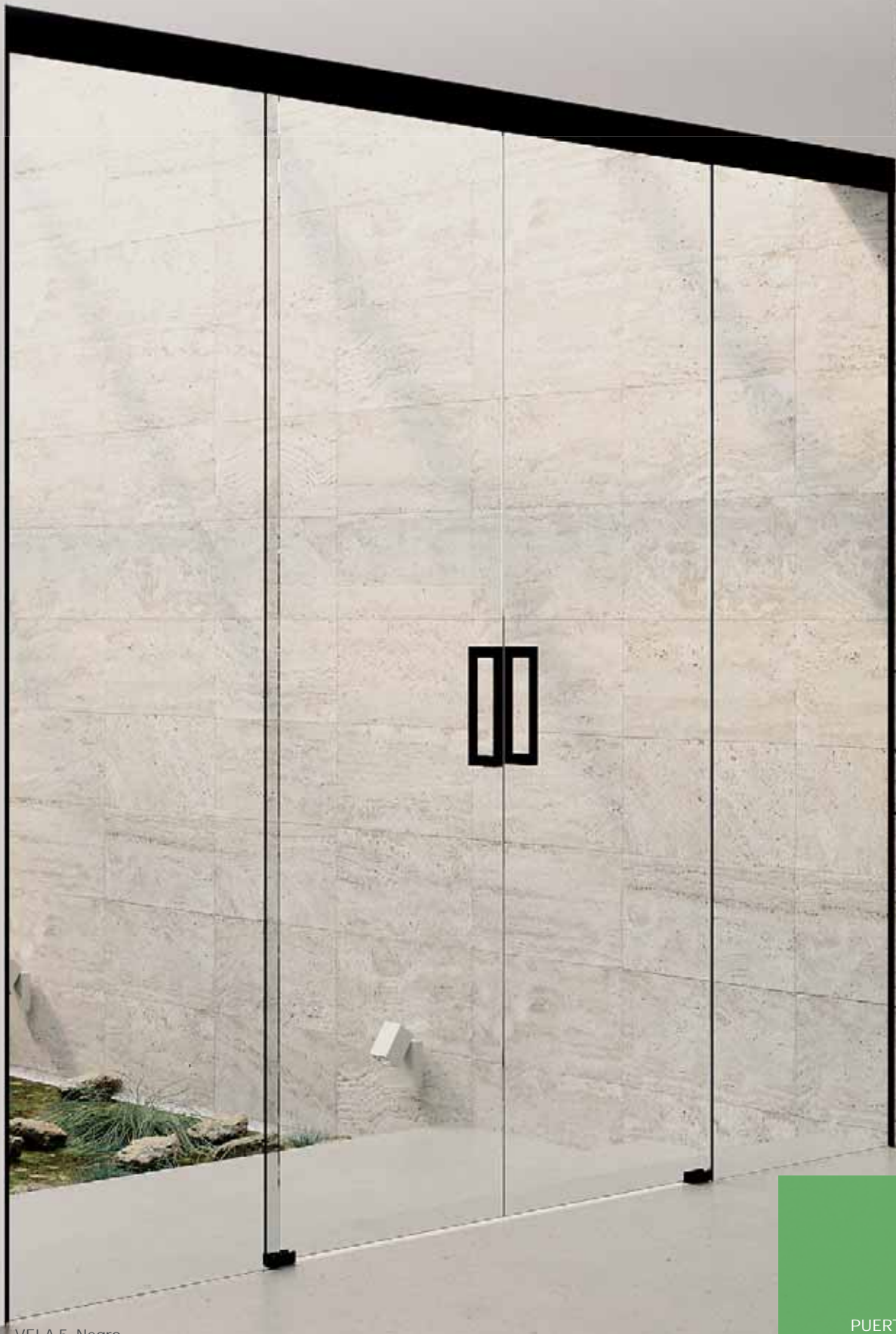

VELA 5. Negro.

PUERTAS DE PASO

VELA 1

Puerta de paso frontal. Una puerta corredera.



FICHA
TÉCNICA



INSTRUCCIONES
DE MONTAJE



FORMULARIO PARA
TOMA DE MEDIDAS

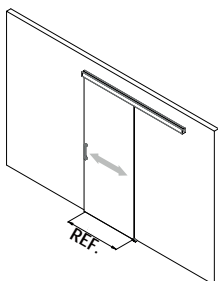
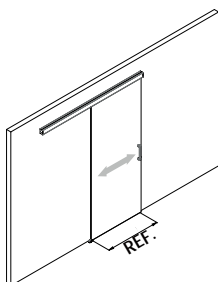

VELA 1. Plata mate. SERIGRAFÍA 1 G

REF.	Medidas en cm.	PVP Cristal transparente
4500	Hasta 80	930
4501	Hasta 110	1.000

+70€
PVP

SERIGRAFÍA 1



Plata mate

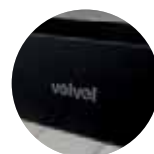

Negro +80€



Blanco +80€



FABRICACIÓN
A MEDIDA



VIDRIO
TEMPLADO
8MM



ALTURA
220CM



CIERRE SUAVE
OPCIONAL
+70€

Indicar dirección de apertura. | Indicar medida exacta del hueco. | Para mayor altura o anchura incremento de 50€ por cada 10cm. | Altura máxima 240cm.

IVA no incluido. Montaje no incluido. Precios en €.

VELA 2

Puertas de paso frontales. Dos puertas correderas.



FICHA
TÉCNICA



INSTRUCCIONES
DE MONTAJE



FORMULARIO PARA
TOMA DE MEDIDAS

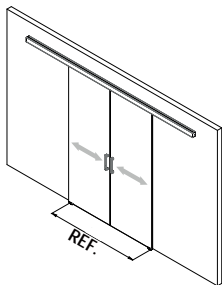

VELA 2. Plata mate.

REF.	Medidas en cm.	PVP Cristal transparente
4510	Hasta 150	1.388
4511	Hasta 180	1.494
4512	Hasta 210	1.599

+70€
PVP

SERIGRAFÍA 1



Plata mate



Negro +80€

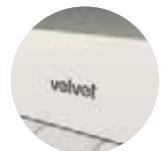

Blanco +80€



FABRICACIÓN
A MEDIDA



VIDRIO
TEMPLADO
8MM



ALTURA
220CM



CIERRE SUAVE
OPCIONAL
+140€

Indicar medida exacta del hueco. | Para mayor altura o anchura incremento de 50€ por cada 10cm. | Altura máxima 240cm.
IVA no incluido. Montaje no incluido. Precios en €.

VELA 3

Puerta de paso frontal. Un fijo y una puerta corredera.



FICHA
TÉCNICA



INSTRUCCIONES
DE MONTAJE



FORMULARIO PARA
TOMA DE MEDIDAS

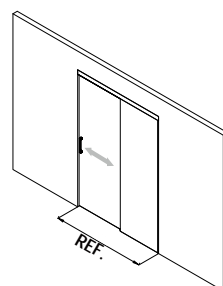
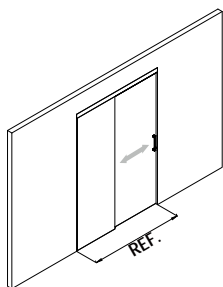

VELA 3. Negro. SERIGRAFÍA 1 B

REF.	Medidas en cm.	PVP Cristal transparente
4520	Hasta 150	1.071
4521	Hasta 180	1.188
4522	Hasta 210	1.306

+70€
PVP

SERIGRAFÍA 1



Plata mate



Negro +80€

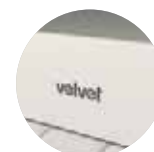

Blanco +80€



FABRICACIÓN
A MEDIDA



VIDRIO
TEMPLADO
8MM



ALTURA
220CM



CIERRE SUAVE
OPCIONAL
+70€

Indicar el lado del fijo. | Indicar medida exacta del hueco. | Para mayor altura o anchura incremento de 50€ por cada 10cm. | Altura máxima 240cm.

IVA no incluido. Montaje no incluido. Precios en €.

VELA 4

Puerta de paso frontal. Dos fijos y una puerta corredera central.



FICHA
TÉCNICA



INSTRUCCIONES
DE MONTAJE



FORMULARIO PARA
TOMA DE MEDIDAS

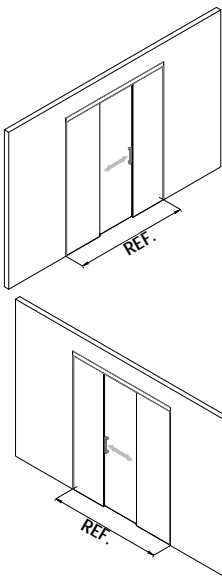

VELA 4. Plata mate.

REF.	Medidas en cm.	PVP Cristal transparente
4530	Hasta 150	1.270
4531	Hasta 180	1.375
4532	Hasta 210	1.482

+70€
PVP

SERIGRAFÍA 1



Plata mate



Negro +80€



Blanco +80€



FABRICACIÓN
A MEDIDA



VIDRIO
TEMPLADO
8MM



ALTURA
220CM



CIERRE SUAVE
OPCIONAL
+70€

Indicar lado del fijo de cierre. | Indicar medida exacta del hueco. | Para mayor altura o anchura incremento de 50€ por cada 10cm. | Altura máxima 240cm.

IVA no incluido. Montaje no incluido. Precios en €.

VELA 5

Puerta de paso frontal. Dos fijos y dos puertas correderas.



FICHA
TÉCNICA



INSTRUCCIONES
DE MONTAJE



FORMULARIO PARA
TOMA DE MEDIDAS

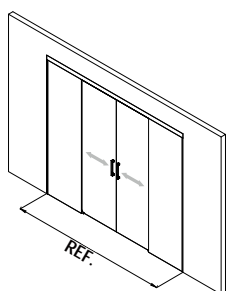

VELA 5. Plata mate.

REF.	Medidas en cm.	PVP Cristal transparente
4540	Hasta 220	1.670
4541	Hasta 250	1.788
4542	Hasta 280	1.905
4543	Hasta 310	2.203
4544	Hasta 340	2.140

+70€
PVP

SERIGRAFÍA 1



Plata mate

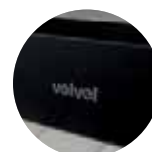

Negro +80€

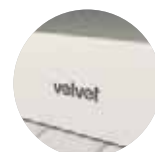

Blanco +80€



FABRICACIÓN
A MEDIDA



VIDRIO
TEMPLADO
8MM



ALTURA
220CM



CIERRE SUAVE
OPCIONAL
+140€

Indicar medida exacta del hueco. | Para mayor altura o anchura incremento de 50€ por cada 10cm. | Altura máxima 240cm.

IVA no incluido. Montaje no incluido. Precios en €.

VELA | OTRAS COMPOSICIONES ESPECIALES*



VELA 3. Negro. + NIDIA 3 OPCIÓN ENMARCADA. Negro. + [OPCIÓN VIDRIO 10MM \(Ver página 10\)](#).



VELA 4. Negro. SERIGRAFÍA 1 G + SINOPE 1 | NELA 11 ESPECIAL. Negro.

*Consultar para cualquier composición especial.

PUERTAS DE PASO

POMOS Y TIRADORES



FICHA TÉCNICA
POMOS Y TIRADORES



31013

POMO XENIA 12
PVP: 70€



31091

POMO EXTRAPLANO XENIA 35
PVP: 70€



31092

TIRADOR SLIM XENIA 41
PVP: 70€



31095

TIRADOR PREMIUM XENIA 42
PVP: 84€



ACCESORIOS Y OPCIONALES

TOALLERO*



REF.	Ancho en cm.	PVP Cromo brillo	PVP Negro	PVP Blanco
31072	Hasta 90	115€	145€	145€

*Para puertas practicables, llevará un pomo XENIA 12 en la parte interior.

TENSOR ARTICULADO*



REF.	Ancho en cm.**	PVP Cromo brillo	PVP Negro	PVP Blanco
31034	Hasta 120	60€	90€	90€
31035	Hasta 40	60€	90€	90€

NIDIA 3 + *TENSOR ARTICULADO: NIDIA 3 PVP + 35€.

**Medida suministrada 120cm o 40cm, pudiendo cortarse a la medida deseada.

IVA no incluido. Montaje no incluido. Precios en €.

ACCESORIOS Y OPCIONALES

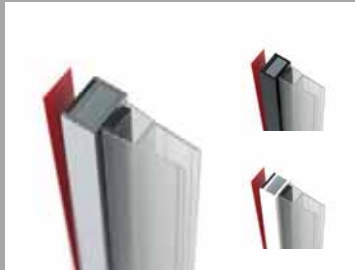

21052
CIERRE MAGNÉTICO ADHESIVO
ORION | POLARIS
PVP: 30€

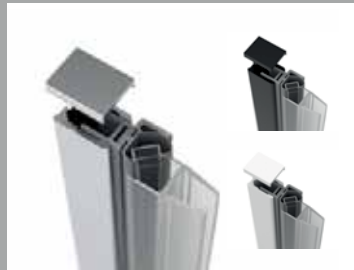

21054
CIERRE MAGNÉTICO ADHESIVO
CON COMPENSACIÓN
PVP: 40€

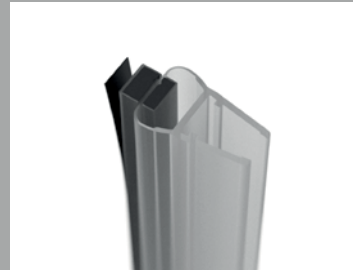

21060
CIERRE MAGNÉTICO ADHESIVO
MINIMALISTA
PVP: 20€



12060
KIT ANTICAL
LIMPIADOR + ANTICAL
PVP: 90€

PLETINAS

Medidas en mm.	PVP*	PLATA BRILLO	PLATA MATE	NEGRO	BLANCO
20 x 1,5	10	x		x	x

ÁNGULOS

Medidas en mm.	PVP*	PLATA BRILLO	PLATA MATE	NEGRO	BLANCO
20 x 20	9	x	x	x	x
30 x 15	10	x	x	x	x
30 x 30	10	x	x	x	x
40 x 20	13	x	x	x	x
40 x 40	14	x	x	x	x
50 x 50	15	x	x	x	x

TUBOS

Medidas en mm.	PVP*	PLATA BRILLO	PLATA MATE	NEGRO	BLANCO
10 x 20	11	x	x	x	x
20 x 20	13	x	x	x	x
24 x 12	15	x	x	x	x
15 x 30	15	x	x	x	x
30 x 30	19	x	x	x	x
40 x 20	19	x	x	x	x
40 x 40	22	x	x	x	v
50 x 25	25	x	x		x
50 x 50	28	x	x		x
60 x 20	24	x	x		x
60 x 40	25	x	x		x
60 x 60	28	x	x		x
80 x 40	30	x	x		x
100 x 40	32	x	x		

*Precio por metro | *X*: Disponible. | IVA no incluido. Montaje no incluido. Precios en €.

RECAMBIOS

MAMPARAS A MEDIDA



07003

CIERRE DE BURBUJA
PVP: 10€/TIRA

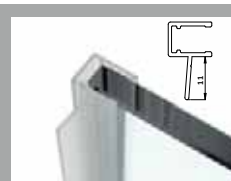

07004

ALETA LATERAL
PVP: 10€/TIRA



07005

ALETA FRONTAL
PVP: 10€/TIRA

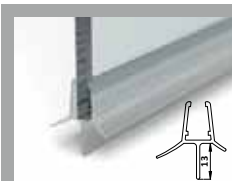

07002

RIBETE ESCUPIDERA 6/8mm
PVP: 12€/METRO



07053

RIBETE ESCUPIDERA
PVP: 12€/METRO



11000

IMÁN
PVP: 12€/TIRA



11000+11000

JUEGO DE IMÁNES FRONTAL
PVP: 24€



11010

IMÁN FRONTAL
PVP: 12€/TIRA



11027

JUEGO DE IMÁNES ANGULAR
PVP: 24€



11002

IMÁN BLANCO Y GRIS
PVP: 12€/TIRA



11013

IMÁN BLANCO Y GRIS
PVP: 12€/TIRA



11006

IMÁN BLANCO Y GRIS
PVP: 12€/TIRA



07011

JUNQUILLO PARA CRISTAL
PVP: 2€/METRO



07022

JUNQUILLO PARA ACRÍLICO
PVP: 2€/METRO



25029

CARRO **LUR**
PVP: 16€/UNIDAD



25128

CARRO **URANIA 3**
PVP: 12€/UNIDAD



25130

CARRO **NISTE**
PVP: 10€/UNIDAD



08003

RUEDA **ORBIT**
PVP: 3€/UNIDAD



10158 I
GUIADOR DESBLOQUEO
LUR | RHEA | ARES
PVP: 17€/UNIDAD

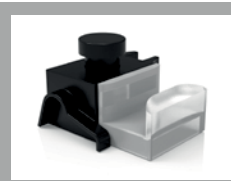

10158 D
GUIADOR DESBLOQUEO
LUR | RHEA | ARES
PVP: 17€/UNIDAD

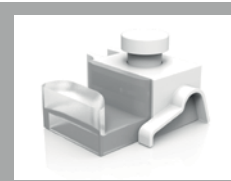
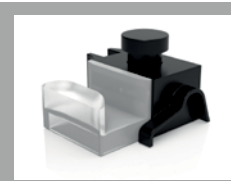

01001

PERFIL VIERTEAGUAS
PVP: 21€/METRO

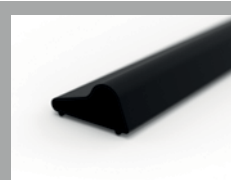

10095 I

TAPA FINAL PERFIL VIERTEAGUAS
PVP: 2€/UNIDAD





















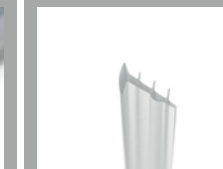





10095 D

TAPA FINAL PERFIL VIERTEAGUAS
PVP: 2€/UNIDAD

RECAMBIOS

MAMPARAS EN STOCK 

 07003 CIERRE DE BURBUJA PVP: 10€/TIRA	 11027 JUEGO DE IMÁNES ANGULAR PVP: 24€	 07058 ALETA LATERAL PVP: 10€/TIRA	 07075 ALETA DE CIERRE PHOENIX PVP: 12€/TIRA	 11000+11000 JUEGO DE IMÁNES FRONTAL PVP: 24€	 07057 RIBETE ESCUPIDERA PVP: 12€/METRO
 07060 GOMA PUERTA CENTRAL TRIDENT PVP: 12€/METRO	 07061 GOMA PUERTA DE CIERRE TRIDENT PVP: 12€/METRO	 07062 ALETA LATERAL TRIDENT PVP: 10€/TIRA	 07063 IMÁN PUERTA TRIDENT PVP: 12€	 07064 RIBETE ESCUPIDERA NUBIA PVP: 12€/METRO	 07011 JUNQUILLO PARA CRISTAL PVP: 2€/METRO
 25132 I GUIADOR DESBLOQUEO TRIDENT PVP: 17€/UNIDAD	 25132 D GUIADOR DESBLOQUEO TRIDENT PVP: 17€/UNIDAD	 25133 RUEDA TRIDENT PVP: 3€/UNIDAD	 10318 I/D CONJUNTO GUIADOR DESBLOQUEO PHOENIX PVP: 12€/CONJUNTO		
 25029 CARRO POLARIS PVP: 16€/UNIDAD	 25030 CARRO PHOENIX PVP: 12€/UNIDAD	 25129 CARRO DIDA SUPERIOR PVP: 12€/UNIDAD	 25138 CARRO DIDA INFERIOR PVP: 12€/UNIDAD	 10138 I GUIADOR DESBLOQUEO ORION PVP: 17€/UNIDAD	 10138 D GUIADOR DESBLOQUEO ORION PVP: 17€/UNIDAD
 01001 PERFIL VIERTEAGUAS PVP: 21€/METRO	 10095 I TAPA FINAL PERFIL VIERTEAGUAS PVP: 2€/UNIDAD	 10095 D TAPA FINAL PERFIL VIERTEAGUAS PVP: 2€/UNIDAD			

ACABADOS*



Cromo brillo



Plata brillo



Plata mate



Negro



Blanco

*Disponibilidad de los acabados según la serie. | IVA no incluido. Montaje no incluido. Precios en €.

SERIGRAFÍAS 1



A. RAYAS DECRECIENTES



B. FRANJA CENTRAL



C. FRANJA CON RAYAS



D. RAYAS CENTRALES



E. FRANJA CON CUADROS



F. CUADROS DESCENDIENTES



G. MATE



H. ONDAS



L. MÁTRIX



NOVEDAD

M. FRANJA SUPERIOR



NOVEDAD

N. DOBLE FRANJA CENTRAL



NOVEDAD

O. MATE CON LÍNEAS

La disponibilidad de las serigrafías pueden variar según cada serie de mampara. Consultar el código QR de cada serie.

SERIGRAFÍAS 2*



A. FRANJAS ONDULADAS



B. OLA



NOVEDAD

I. MOSAICOS ORGÁNICOS



NOVEDAD

J. CÍRCULOS INFINITOS



NOVEDAD

K. PRIMAVERA



NOVEDAD

L. LÍNEAS SUAVES



NOVEDAD

M. SELVA



EJEMPLO

P. PERSONALIZADA**



G. CRISTAL FUMÉ GRIS***



H. CRISTAL FUMÉ BRONCE***

*SERIGRAFÍA 2 PERSONALIZABLE: Posibilidad de invertir el motivo/dibujo. | Consultar precios y plazos de entrega. La disponibilidad de las serigrafías pueden variar según cada serie de mampara. Consultar el código QR de cada serie.

**Diseño personalizado. | Diseño proporcionado por el cliente. | Presupuesto según características del diseño.

***Apto sólo para modelos de fabricación a medida en vidrios de 6mm.

TOMA DE MEDIDAS

MAMPARA FRONTAL

DUCHA O BAÑERA

- TOMAR LAS MEDIDAS EN LOS PUNTOS A, B Y C.
- SI HUBIERA UNA DIFERENCIA DE MÁS DE 10mm, INDICAR QUE LA PARED TIENE DESPLOME.
- COMPROBAR QUE EL PLATO ESTÉ NIVELADO.

MAMPARA ANGULAR

DUCHA O BAÑERA

- **INDICAR EL TIPO DE PLATO INSTALADO.***
- TOMAR LAS MEDIDAS EXTERIORES DE X Y Y. VELVET HARÁ LOS DESCUENTOS NECESARIOS.
- INDICAR SI LAS PAREDES A Y B TIENEN ALGÚN DESPLOME.
- COMPROBAR QUE EL PLATO ESTÉ NIVELADO.

MAMPARA SEMICIRCULAR

- INDICAR EL MODELO DE PLATO INSTALADO PARA DETERMINAR EL RADIO DE LA CURVA.
- TOMAR LA MEDIDA DE LA DIAGONAL R.
- TOMAR LAS MEDIDAS EXTERIORES DE X Y Y. VELVET HARÁ LOS DESCUENTOS NECESARIOS.
- INDICAR SI LAS PAREDES A Y B TIENEN ALGÚN DESPLOME.
- COMPROBAR QUE EL PLATO ESTÉ NIVELADO.

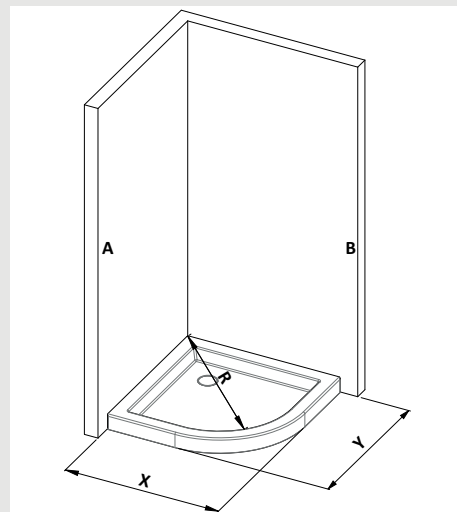
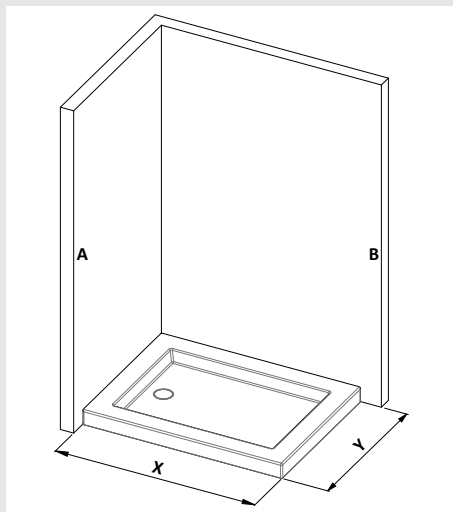
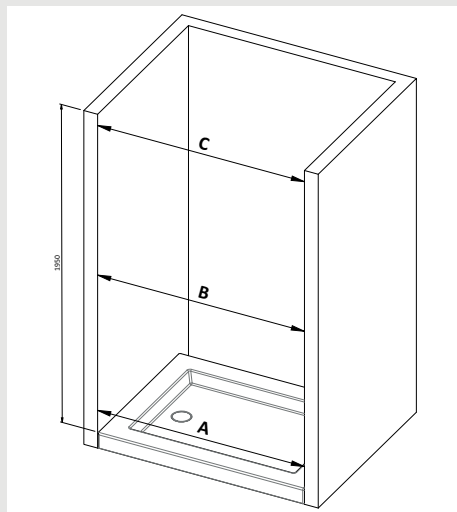

*Si no se indica el tipo de plato en el pedido, la mampara se fabricará para **PLATO NORMAL**.

TIPOS DE PLATO

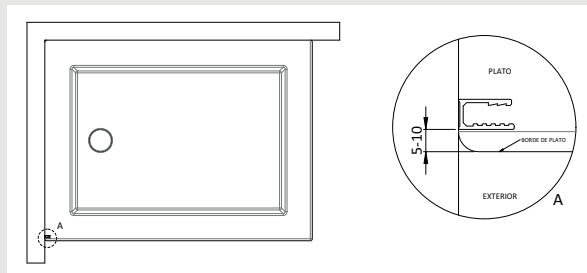

PLATO NORMAL

TOMAR LAS MEDIDAS EXTERIORES, DE PARED A FINAL DE PLATO. VELVET HARÁ LOS DESCUENTOS NECESARIOS EN LAS MEDIDAS FINALES, PARA QUE LA MAMPARA QUEDE ENTRE 5mm a 10mm DENTRO DEL PLATO DE DUCHA.

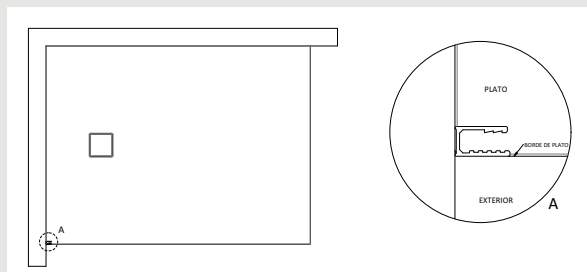

PLATO DE OBRA

TOMAR LAS MEDIDAS EXTERIORES, DE PARED A FINAL DE PLATO. VELVET NO HARÁ NINGÚN DESCUENTO EN LAS MEDIDAS FINALES. LA MAMPARA QUEDARÁ AJUSTADA AL PLATO DE DUCHA DE OBRA.

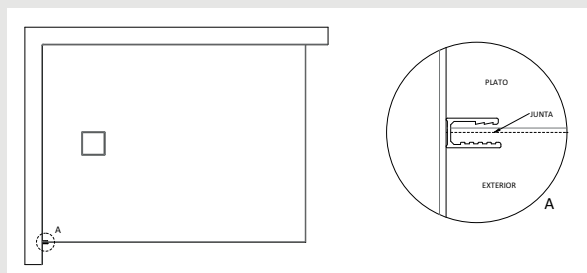

PLATO ENRASADO (CAMBIO DE AMBIENTE)

TOMAR LAS MEDIDAS DE PARED HASTA LA JUNTA (CAMBIO DE AMBIENTE). VELVET HARÁ LOS CÁLCULOS NECESARIOS PARA QUE LA MAMPARA QUEDE ENCIMA DE LAS JUNTAS, TAPÁNDOLAS Y DANDO UN MEJOR ACABADO AL AMBIENTE.

HOJA PARA PEDIDOS

CLIENTE	FECHA	
DIRECCIÓN	POBLACIÓN	
TELÉFONO	MÓVIL	S/PEDIDO

MONTAJE	SI <input type="checkbox"/>	NO <input type="checkbox"/>	REF. MONTAJE	MONTADOR
DIRECCIÓN MONTAJE			POBLACIÓN	
TELÉFONO DE CONTACTO			MÓVIL	

SERIE	MODELO	REF.	CANTIDAD		
DESCRIPCIÓN					
LADO DEL FIJO (VISTO DE FRENTE)	IZO. <input type="checkbox"/>	DER. <input type="checkbox"/>	PLANTILLA	SI <input type="checkbox"/>	NO <input type="checkbox"/>

PERFILES	TIPO DE VIDRIO	SERIGRAFÍA 1		SERIGRAFÍA 2	
Cromo brillo <input type="checkbox"/>	Cristal transparente <input type="checkbox"/>	A. RAYAS DECRECIENTES <input type="checkbox"/>	G. MATE <input type="checkbox"/>	A. FRANJAS ONDULADAS <input type="checkbox"/>	M. SELVA <input type="checkbox"/>
Plata brillo <input type="checkbox"/>	Placa poliestireno <input type="checkbox"/>	B. FRANJA CENTRAL <input type="checkbox"/>	H. ONDAS <input type="checkbox"/>	B. OLA <input type="checkbox"/>	P. PERSONALIZADA <input type="checkbox"/>
Plata mate <input type="checkbox"/>		C. FRANJA CON RAYAS <input type="checkbox"/>	L. MÁTRIX <input type="checkbox"/>	I. MOSAICOS ORGÁNICOS <input type="checkbox"/>	L. CRISTAL FUMÉ GRIS <input type="checkbox"/>
Negro <input type="checkbox"/>		D. RAYAS CENTRALES <input type="checkbox"/>	M. FRANJA SUPERIOR <input type="checkbox"/>	J. CÍRCULOS INFINITOS <input type="checkbox"/>	L. CRISTAL FUMÉ BRONCE <input type="checkbox"/>
Blanco <input type="checkbox"/>		E. FRANJA CON CUADROS <input type="checkbox"/>	N. DOBLE FRANJA CENTRAL <input type="checkbox"/>	K. PRIMAVERA <input type="checkbox"/>	
		F. CUADROS DESCENDIENTES <input type="checkbox"/>	O. MATE CON LÍNEAS <input type="checkbox"/>	L. LÍNEAS SUAVES <input type="checkbox"/>	

TRATAMIENTO ANTICAL	SI <input type="checkbox"/>	NO <input type="checkbox"/>
---------------------	-----------------------------	-----------------------------

CROQUIS | OBSERVACIONES



DESCARGAR
HOJA PARA PEDIDOS

CONDICIONES GENERALES DE VENTA

PEDIDOS

Los pedidos deberán ser enviados vía e-mail a: pedidos@mamparasvelvet.com

Les recomendamos utilizar nuestra [HOJA PARA PEDIDO \(página 157\)](#) para agilizar el proceso.

Indicar las medidas según se especifica en la página 156.

Los pedidos se consideran en firme desde el mismo momento de su recepción. En caso de modificación o anulación, una vez entrados en el proceso de fabricación, VELVET se reserva el derecho de facturar un 25% del valor del pedido, en concepto de perjuicios y gastos ocasionados.

VELVET se reserva el derecho de introducir cualquier modificación en sus productos sin previo aviso.

DEVOLUCIONES

No se aceptará ninguna devolución sin que previamente VELVET haya dado su autorización. En dicho caso antes de aceptar el envío se fijará un cargo del 30% del valor del pedido más 35€ de portes, en concepto de gastos de recepción, revisión y depreciación de material. No se aceptará ninguna devolución de artículos personalizados, fabricaciones especiales o serigrafiados.

PRECIOS

Los precios indicados en la tarifa vigente son recomendados para venta al público. No incluyen IVA ni montaje.

VELVET se reserva el derecho de revisar y/o variar dichos precios sin previo aviso.

PORTES

Los portes serán pagados en la Península y Baleares para importes superiores a 120€ netos, excepto nuestras mamparas de stock, que se enviarán a portes pagados con indiferencia del precio, siempre y cuando se envíe la mampara completa. Para importes inferiores, los portes irán cargados en la factura, con un cargo de 20€ netos. Para grandes dimensiones consultar previamente.

TRANSPORTE

La mercancía está asegurada. En el momento de su recepción se debe comprobar el número de bultos entregados y se debe revisar la mercancía. No se debe aceptar en caso de deterioro. Si se detecta alguna anomalía en el embalaje se debe comunicar al chofer, e indicar detalladamente el daño de la mercancía.

Posteriormente, se debe comunicar a la brevedad la incidencia a VELVET. Las agencias de transporte no admiten reclamaciones por roturas o deterioros después de la entrega, y pasado ese período, VELVET no se responsabilizará de los daños.

GARANTÍA

Todos nuestros productos están garantizados ante cualquier defecto de fabricación, durante tres años a partir de la fecha de factura. La garantía queda limitada a la reparación o cambio de las piezas defectuosas. La garantía no cubre gomas de estanqueidad ni otros elementos de desgaste. Tampoco cubrirá deterioros no imputables al producto o derivados de negligencias en su manipulación. También quedan excluidos de la garantía los daños provocados por la utilización de productos de limpieza que contengan lejías, ácidos, amoniacos, etc... Los productos abrasivos dañan los perfiles, la protección antical, serigrafía del vidrio, juntas de estanqueidad, etc...

VELVET garantiza las instalaciones efectuadas exclusivamente por nuestro Servicio Técnico Oficial.

CONDICIONES DE PAGO

VELVET se reserva el dominio de propiedad sobre toda la mercancía suministrada o retener los pedidos en curso, hasta que se haya hecho efectivo el pago total de la misma.

Las facturas que resulten impagadas, total o parcialmente, a la fecha de su vencimiento, generarán gastos adicionales que serán a cargo del cliente:

- Por gastos de devolución: Se le hará un cargo al cliente de las comisiones y gastos bancarios originados por el impago del recibo.
- Por intereses de demora: Se le hará un cargo al cliente, al tipo de interés legal según ley 3/2004 sobre medidas de lucha contra la morosidad en operaciones comerciales.

PLAZOS DE ENTREGA

Los plazos de entrega serán notificados en la confirmación del pedido, son orientativos y no suponen ningún compromiso contractual. No se aceptarán reclamaciones de responsabilidades a ningún efecto.

La Condiciones Generales de Venta se consideran aceptadas en el momento de cursar el pedido.

NOTAS

CATÁLOGO
V.24

CATÁLOGO
V.24



Velvet

velvet[®]
MAMPARAS DE BAÑO

pedidos@mamparasvelvet.com
info@mamparasvelvet.com
+34 937 713 344





VELVET

velvet[®]
MAMPARAS DE BAÑO

Vielmar, S.A.

C/ Marie Curie 3, 08635. P.I. Sant Esteve Sesrovires, Barcelona
+34 937 713 344 | pedidos@mamparasvelvet.com | info@mamparasvelvet.com
www.mamparasvelvet.com