

TARIFA

Decoración

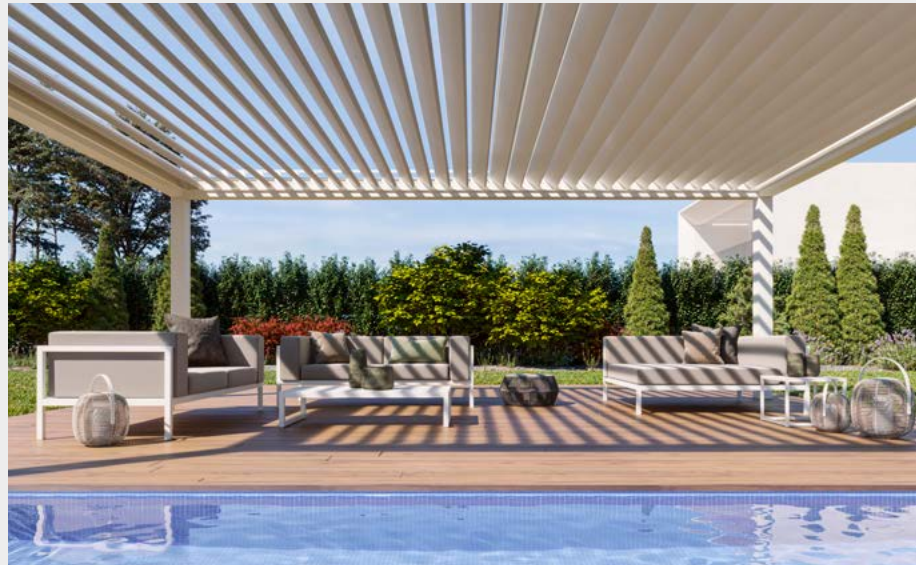

saxun[•]
Tu mundo, nuestro universo.





Un universo de posibilidades casi infinito.
En Saxun tenemos un claro propósito: contribuir al bienestar y a la felicidad de las personas aportando soluciones que mejoren los espacios de sus vidas.

Te ofrecemos la gamas más amplia y variada del mercado en soluciones de Protección Solar, para controlar la luz y el calor con elegancia, belleza y eficiencia.

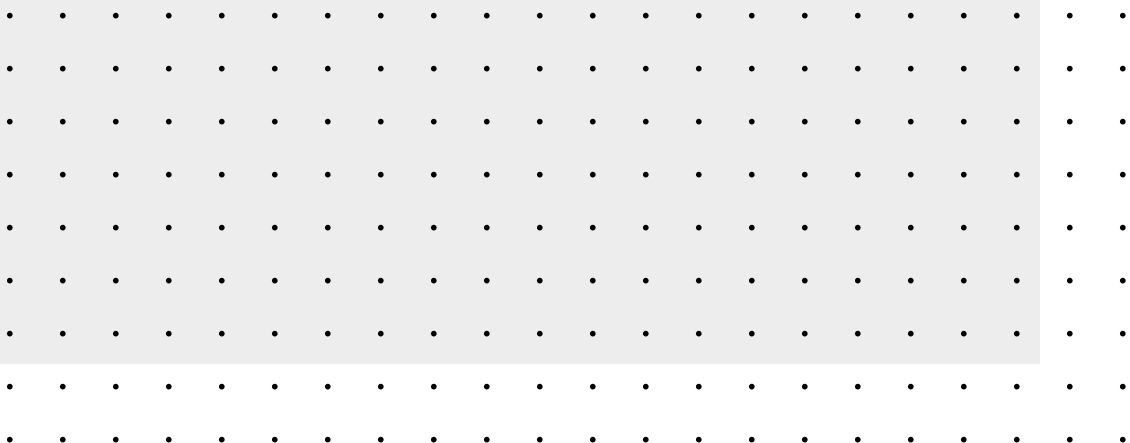

Sede central

Giménez Ganga, S.L.U.

Polígono Industrial El Castillo
C/ Roma, 4
03630 • Sax (Alicante) • España
T. +34 965 474 050 • 965 474 205
F. +34 965 474 563

saxun.com

Delegaciones

ALBACETE

Polígono Industrial Campollano
C/ B 14. Nave A
02007 • Albacete
T. (+34) 967 201 488
E. albacete@saxun.com

ALMERÍA

Polígono Industrial La Juaida
C/ Sierra de Atalaya, 35
04240 • Viator (Almería)
T. (+34) 950 306 693
F. (+34) 950 306 729
E. almeria@saxun.com

ARAGÓN

Polígono Industrial Las Rozas II
C/ C Parcela 510
50660 • Tauste (Zaragoza)
T. (+34) 976 866 171
E. aragon@saxun.com

ASTURIAS

C/ Guillermo Rodríguez Quirós,
parc. 2.9 B, Nº3
33393 • Sotiello (Asturias)
T. (+34) 985 887 300
F. (+34) 985 887 971
E. asturias@saxun.com

BALEARES

Polígono Industrial Son Castelló
C/ Gremi Sellaers i Basters, 6
Nave-2
07009 • Palma de Mallorca
T. (+34) 971 430 191
F. (+34) 971 432 719
E. baleares@saxun.com

BARCELONA

Polígono Industrial Santa
Margarida
C/ Pisuerga, 45, naves B y C
08223 • Terrasa (Barcelona)
T. (+34) 937 863 111
F. (+34) 937 856 623
E. barcelona@saxun.com

CASTILLA LA MANCHA

Polígono Industrial Pozo-Hondo
Avda. Castilla León, parcela 36
13610 • Campo de Criptana
(Ciudad Real)
T. (+34) 926 564 199
F. (+34) 926 563 765
E. lamancha@saxun.com

CASTILLA Y LEÓN

Polígono Industrial El Brizo
C/ Pino Albar, parcela nº 127-128,
Nave s/n
47162 • Aldeamayor de San Martín
(Valladolid)
T. (+34) 983 528 255
F. (+34) 983 528 061
E. castillayleon@saxun.com

CIUDAD REAL

Polígono Industrial Las Viñas
C/ Valencia, 21
13420 • Malagón (Ciudad Real)
T. (+34) 926 266 015
F. (+34) 926 266 016
E. ciudadreal@saxun.com

CÓRDOBA

Polígono Industrial Llanos de Jarata
C/ Alejandro Goicoechea, Nave 30-32
14550 • Montilla (Córdoba)
T. (+34) 957 651 900
F. (+34) 957 653 102
E. cordoba@saxun.com

EXTREMADURA

Carretera de Jarandilla, 54
10300 • Navalmoral de la Mata
(Cáceres)
T. (+34) 927 530 170
F. (+34) 927 538 036
E. extremadura@saxun.com

GALICIA

Polígono Industrial El Tambre
Vía Diesel, R4
15890 • Santiago de Compostela
(La Coruña)
T. (+34) 881 549 107
F. (+34) 881 549 166
E. galicia@saxun.com

GRAN CANARIA

Polígono Industrial Arinaga
C/ Los Dragos, s/n parcela 64
35118 • Agüimes
(Las Palmas de Gran Canaria)
T. (+34) 928 799 531
F. (+34) 928 799 518
E. grancanaria@saxun.com

GRANADA

Polígono Industrial Juncaril
C/ Montejicar Nave 31 y 32
18210 • Peligros (Granada)
T. (+34) 958 582 910
F. (+34) 958 582 915
E. granada@saxun.com

JAÉN

Polígono Industrial Los Cerros de Úbeda
C/ Cerámica, 7
23400 • Úbeda (Jaén)
T. (+34) 953 793 065
F. (+34) 953 796 474
E. jaen@saxun.com

MADRID

Polígono Industrial Villa de Yuncos
Avda. de los Austrias, 10 Nave 94
45210 • Yuncos (Toledo)
T. (+34) 925 536 172
F. (+34) 925 525 169
E. madrid@saxun.com

MÁLAGA

Polígono Industrial Guadalhorce
Ctra. de la Azucarera Intelhorce, 66
29004 • Málaga
T. (+34) 952 105 351
F. (+34) 952 243 799
E. malaga@saxun.com

PAÍS VASCO

Polígono Industrial Bayas
C/ Ircio, parcela 122 • Pabellón 31
09200 • Miranda de Ebro (Burgos)
T. (+34) 947 426 565
F. (+34) 947 342 324
E. paisvasco@saxun.com

SEVILLA

Polígono Industrial Parsi
C/ Las Melias parcela 806-807
41016 • Sevilla
T. (+34) 955 187 011
F. (+34) 955 187 012
E. sevilla@saxun.com

TARRAGONA

Polígono Industrial, C/ L' Arbocet, 2
43340 • Montbrío del Camp
(Tarragona)
T. (+34) 977 826 008
F. (+34) 977 826 575
E. tarragona@saxun.com

TENERIFE

Polígono Industrial Valle de Güimar
Parcela 9 y 10 • Manzana IX
38509 • Candelaria (Santa Cruz de
Tenerife)
T. (+34) 822 127 896
E. tenerife@saxun.com

VALENCIA

Polígono Industrial Els Mollons
C/ Dels Traginers, 61
46970 • Alaquàs (Valencia)
T. (+34) 961 347 505
F. (+34) 961 349 310
E. valencia@saxun.com



SHOWROOM MADRID

C/ Juan de Arespacochaga
y Felipe, 12
28037 Madrid

CONDICIONES GENERALES DE VENTA

1. Todos los pedidos deberán ir firmados por el cliente o remitidos mediante fax o internet para ser admitidos; en caso de ser cursado telefónicamente, será responsabilidad del cliente cualquier error que se produzca.
2. Los precios cotizados son franco fábrica, siendo por cuenta del comprador los portes, viajando la mercancía por cuenta y riesgo del mismo, "franco embalajes".
3. Los precios reflejados en esta tarifa no incluyen I.V.A., por lo que se aplicará al final de cada factura, según los tipos actuales en ese momento.
4. Nuestros fabricados se sirven en las medidas, modelos y colores solicitados por el cliente, cuyos datos se consignarán en los impresos de pedidos que ponemos a su disposición.

Advertencia: Los despieces representados en los dibujos técnicos identifican elementos funcionales del sistema representado. La mejora continua de nuestros productos y sistemas puede ser de diferente apariencia a la representación gráfica de alguno de los elementos.

En cualquier caso, aunque la pieza o componente realmente suministrado no coincida exactamente con el aspecto de su representación gráfica, desempeña a la perfección la función descrita y es, por tanto, equivalente a su representación.
5. Para efectos de precio, las medidas se redondean por exceso de 5 en 5 cm, excepto cuando se haga según cuadrante.
6. La forma de pago será a la entrega de la mercancía, salvo acuerdo expreso con el cliente.
7. El incumplimiento de cualquier pago estipulado, supondrá la antelación del importe de los pedidos que nos solicite.
8. No se admitirá ninguna reclamación que se curse pasados ocho días laborables desde la fecha de recepción de la mercancía.

En caso de alegar desperfectos en la mercancía o recepción de pedidos incompletos no se admitirán reclamaciones transcurridas 48 horas desde la recepción de dicha mercancía; si el envío se ha realizado a través de una agencia de transporte, el plazo de reclamación será de 24h y se deberá de aportar:

- Foto del daño de la mercancía, foto del embalaje externo e interno, foto de la etiqueta de la agencia, además de notificarlo al repartidor.
En caso de productos de vidrio con alguna anomalía o defecto la empresa no se hará responsable una vez entregada y verificada la mercancía al cliente pasado un plazo de 24h.

9. Debido a que nuestra empresa no será el instalador de sus productos, no podemos hacernos responsables de ningún desperfecto o daño que causen los mismos, siendo el instalador el responsable de esto.
10. No nos responsabilizaremos de los productos que:
 - Hayan sido manipulados indebidamente o presenten signos de haber recibido golpes.
 - Hayan sido utilizados en fines diferentes para los que fueron fabricados.
 - Hayan sido instalados junto a otros accesorios no homologados por nuestros técnicos.
 - Hayan sido instalados incorrectamente.
11. El plazo de entrega será de 20 días hábiles desde la confirmación del pedido, salvo que se hayan establecido plazos expresos sobre algún determinado pedido.
12. Acabados superficiales:
 - Lacados según especificación Qualicoat.
 - Anodizados según especificación Qualanod.
 - Acabados maderas según especificación Qualideco.
13. Previa solicitud del cliente, la empresa se reserva el derecho de admitir - o no - devolución de materiales o productos excedentes del cliente.

En este caso, se aplicará una depreciación del 35% del valor de la mercancía tras la verificación de su conformidad en nuestras instalaciones. Los gastos de transporte hasta nuestra empresa correrán a cargo del cliente.

Son múltiples los colores y acabados que proponemos en nuestras pérgolas, con un amplio abanico de colores de la carta RAL, anodizados y lacados madera, foliados o colores texturados.

Colores y acabados con la garantía que conllevan los sellos de calidad más importantes.



CERTIFICADO DE GARANTÍA

La presente garantía se aplicará exclusivamente cuando la falta de conformidad exista, aunque no se perciba, en el momento de nuestro suministro.

No se aplicará al desgaste propio del uso, ni a disfunciones, defectos o roturas causadas posteriormente por maniobras forzadas o violentas.

1. Periodo de garantía

El periodo de garantía para los suministros Saxun es de 3 años naturales (conforme al Real decreto Ley 7/2021, que entrará en vigor el 1 de enero de 2022), a partir de la fecha de suministro del producto reclamado, entendiendo como tal la fecha del correspondiente albarán emitido por Giménez Ganga, S.L.U.

- Si la fecha de suministro es anterior al 1 de enero de 2022, la garantía será de 2 años desde la fecha de venta.
- Si la fecha de suministro es posterior al 1 de enero de 2022, la garantía será de 3 años desde la fecha de venta.

2. Extensión de la garantía

Nuestra garantía responde de:

- Los materiales/elementos/productos requeridos para restaurar la conformidad del artículo.
- La mano de obra de la reparación, siempre y cuando el cliente proporcione a Giménez Ganga, S.L.U. el producto o sistema objeto de la garantía, para su reparación.
- El transporte de los materiales/elementos/productos sustitutivos o reparados, hasta la dirección que el cliente ha establecido como la de destino habitual de nuestros suministros.

La garantía de Giménez Ganga, S.L.U. en ningún caso cubre otros gastos, tales como los de desmontaje, montaje, desplazamiento, transporte o cualquier otro gasto adicional ocasionado al cliente por las actividades asociadas a la gestión de la reclamación en garantía. Asimismo, quedan excluidos de la garantía los costes por paro técnico, pérdida de explotación, lucro cesante, privación de uso o pérdida de imagen.

3. Procedimiento y requisitos para la reclamación en garantía

Esta garantía sólo surtirá efecto cuando el producto reclamado haya sido completamente pagado en los términos pactados entre las partes en las condiciones de venta.

El cliente presentará una reclamación por escrito (correo postal, correo electrónico, fax...) con la descripción inequívoca del producto reclamado, la información complementaria que considere pertinente, y referencia al nº de factura de Giménez Ganga, S.L.U. asociado al suministro.

En función de la naturaleza de la reclamación y al objeto de restaurar la conformidad del producto, Giménez Ganga, S.L.U. optará entre:

- La sustitución del material/elemento/producto reclamado por uno nuevo.
- La reparación en las instalaciones de Giménez Ganga, S.L.U. del producto no conforme.
- En todo caso, el cliente proporcionará a Giménez Ganga, S.L.U. el material/elemento/producto reclamado y correrán por cuenta del primero, los gastos de desmontaje en las instalaciones de

su cliente y de transporte del material/elemento producto al centro de producción de Giménez Ganga, S.L.U.

- Giménez Ganga, S.L.U. sólo atenderá reclamaciones tramitadas por sus clientes directos. En ningún caso atenderemos reclamaciones de terceros, poseedores o usuarios de algún suministro de Giménez Ganga, S.L.U., que no sean nuestros clientes directos.

4. Garantía para productos descatalogados

Cuando el material/elemento/producto acogido a garantía se encuentre descatalogado y no pueda ser sustituido por otro exactamente igual, será sustituido por la referencia funcionalmente equivalente y de estética más próxima al originalmente reclamado.

5. Exclusiones de la garantía

No podrá reclamarse bajo esta garantía el material/elemento/producto en los siguientes casos:

- Productos distintos a los suministrados bajo la marca Saxun.
- Productos de vidrio con alguna anomalía o defecto que tras la verificación y entrega de la mercancía no se hayan revisado y puesta la reclamación en un plazo máximo de 24h.
- Daños o defectos sobre el producto causados por percances, accidentes, incendios, catástrofes naturales u otras causas de fuerza mayor con posterioridad a su entrega por Giménez Ganga, S.L.U.
- Productos sometidos a un uso distinto al uso previsto en la documentación técnico-comercial de Giménez Ganga, S.L.U.
- Daños o defectos causados por el instalador.
- Daños o defectos causados por un mal uso del usuario.
- Pérdida de funcionalidad o de prestaciones por acumulación de suciedad o inclusión de objetos extraños entre partes móviles del producto.
- Productos que hayan sufrido modificaciones no autorizadas expresamente por Giménez Ganga, S.L.U. respecto de su diseño original o que hayan incorporado materiales/elementos/productos no suministrados por Giménez Ganga, S.L.U. o no hayan sido autorizados expresamente por ésta.
- Productos que excedan de las dimensiones recomendadas por Giménez Ganga, S.L.U. y hayan sido suministrados bajo petición expresa del cliente.
- Productos que hayan sido sometidos a esfuerzos que excedan de las prestaciones de su uso previsto.
- Productos para exterior instalados a una distancia inferior a 2.500 m del mar o de cualquier foco de emisiones que libere a la atmósfera sustancias agresivas o corrosivas.
- Productos que evidencien un mantenimiento deficiente respecto de las operaciones de mantenimiento prescritas por Giménez Ganga, S.L.U.

ESPECIFICACIONES CALIDAD PRODUCTO

Información importante y recomendaciones para tejidos de cortinas.

• Ondulaciones

Para evitar ondulaciones y falta de tensión en los laterales de los tejidos a aplicar en los Estores enrollables, recomendamos que el corte del tejido a utilizar se limite al ancho del rollo, así como evitar realizar añadidos de tejidos en fabricación.



• Imperfecciones en forma de V

Cuando el eje del Estor enrollable soporta todo el peso del tejido, el terminal y el eje sufren una curvatura que en ocasiones genera una arruga en forma de V. Esta imperfección no será admitida como reclamación.

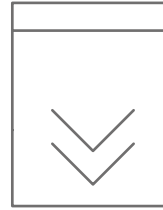

• Observación de los Tejidos

Para un óptimo control de calidad del producto, la observación debe de hacerse al menos a 1 metros de distancia, desde una visión frontal, que puede ser centrada a la Cortina o en ángulos de 45° a ambos lados.

La comprobación debe realizarse con luz frontal o a contraluz. Quedan invalidadas las comprobaciones con iluminación añadida, ya sea a través de proyectores o focos.

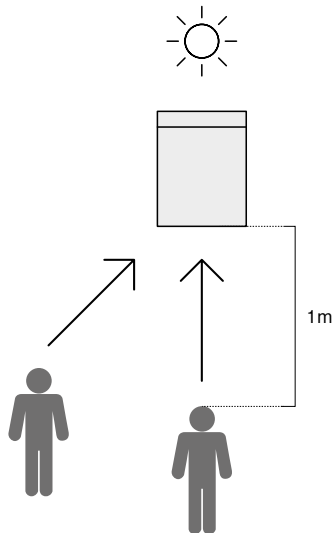

• Altura Estor enrollable y desviación asimétrica de subida y bajada

Puede tener una desviación y asimetría de +/- 6 mm.

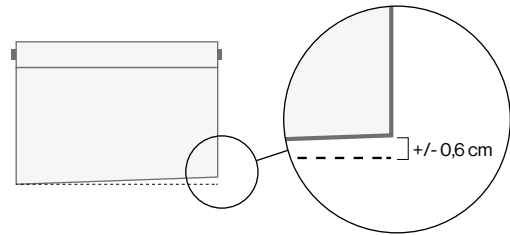

ESPECIFICACIONES ESTOR VISION



La combinación de varias franjas en los tejidos de los Estores Vision puede dibujar pequeñas ondulaciones o bolsas, propias de este tipo de solución, al igual que variaciones de textura y color, respecto a la muestra, que no se aceptarán como motivo de reclamación.

• Alineación franjas Visión

La desviación entre estos productos, instalados correlativos, tendrá una tolerancia de hasta ± 1 cm

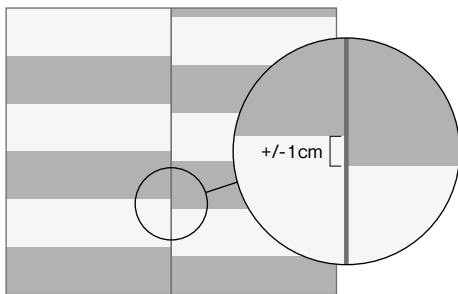

• Altura cortina enrollable y desviación asimétrica subida y bajada

La alineación en altura puede tener una desviación y asimetría de ± 6 mm



• La alineación en altura puede tener una desviación y asimetría de ± 6 mm

Es necesario tener en cuenta que en determinados modelos de tejido para Estores enrollables puede darse el llamado efecto moiré, que es un resultado de una distorsión óptica originado por la superposición de dos rejillas de líneas que tienen diferentes tamaños o ángulos. Este patrón genera un efecto de onda o fluctuante.

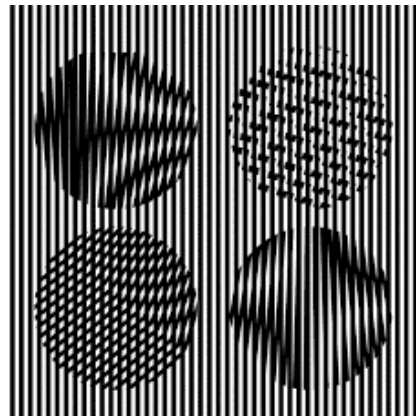

Presupuestador



Accede a nuestro Área de Clientes en saxun.com para gestionar tus presupuestos de forma rápida y sencilla. Utilizando tu Código de Cliente y la Contraseña habitual, tendrás acceso a nuestro nuevo presupuestador.

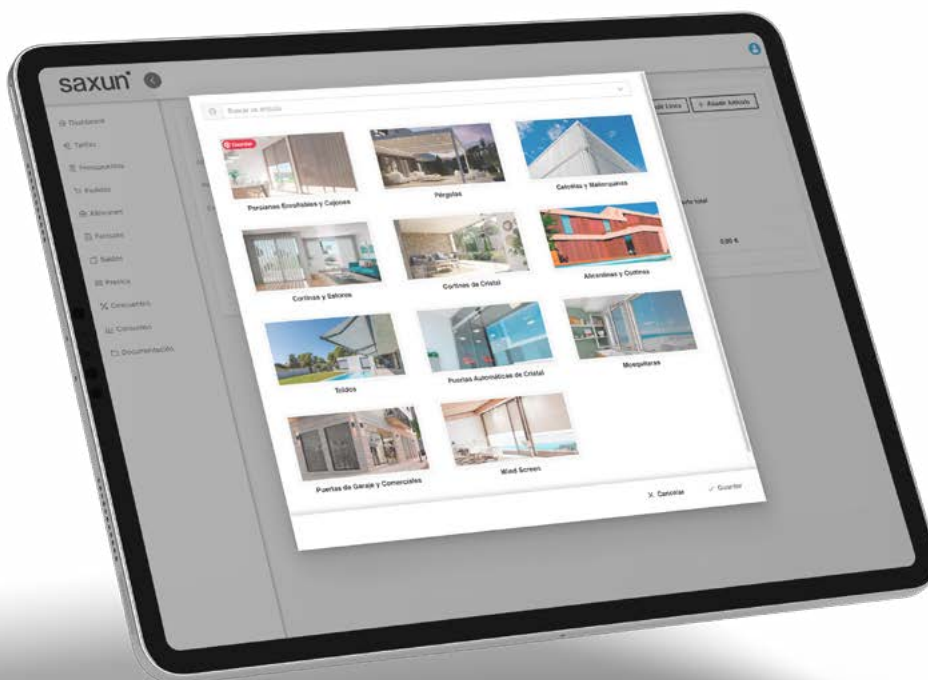

Con esta renovada plataforma, podrás disfrutar de las siguientes ventajas:



Navegación más ágil e intuitiva.



Posibilidad de modificar presupuestos previos y productos ya guardados en presupuestos terminados.



Función para duplicar filas del mismo producto, lo que te permitirá ajustar unidades, medidas u otras características sin repetir el proceso desde cero.



Personalización instantánea con imágenes de todas nuestras soluciones y una amplia selección de colores disponibles.



Además, tendrás acceso a todos los presupuestos archivados de la edición anterior, para facilitar la gestión de tus proyectos.

Haz clic o escanea para acceder al **Presupuestador**



Descargas



Ponemos a tu disposición un acceso directo a nuestra base de datos donde podrás comprobar las últimas actualizaciones en cuanto a colores disponibles, así como los incrementos que conllevan los acabados en colores lacados, foliados y anodizados.



Colores disponibles



Te facilitamos un acceso directo y constantemente actualizado a nuestra amplia gama de colores disponibles y los incrementos de colores lacados, foliados y anodizados.

[VER ACABADOS DISPONIBLES](#)



Incremento de colores lacados, foliados y anodizados



[VER INCREMENTOS](#)



Hojas de pedidos



Ponemos a tu disposición las Hojas de pedido de todas nuestras soluciones de Decoración, para una gestión más rápida y eficiente.

Tendrás la opción de editar, descargar y enviar tus pedidos de forma directa y sencilla.

- > Cortina tradicional
- > Fantasia
- > Plegable y Pachetto
- > Plisada
- > Plisada 27 especial
- > Panel deslizante
- > Vertical
- > Stor glass extra
- > Stor glass intra
- > Stor glass avant
- > Plisada glass
- > Vision
- > Sistemas especiales
- > Galería
- > Veneciana de madera
- > Veneciana de aluminio
- > Enrollable CLS
- > Cortina horizontal



Ensayos de viento



Para asegurar una correcta aplicación de nuestras soluciones de Protección Solar, contamos con fiables ensayos de resistencia al viento.

Estos ensayos son fundamentales tanto en el proceso de fabricación como en la automatización y adaptación de cada producto.

[CONSULTAR ENSAYOS](#)

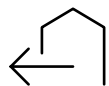

Índice

Decoración

- 14 Veneciana de aluminio**
- 19 Veneciana de madera**
- 21 Estor enrollable**
- 49 Vision**
- 55 Stor Glass Intra y Extra**
- 65 Cortina horizontal**
- 69 Cortina vertical**
- 83 Panel deslizante**
- 89 Plisada**
- 98 Plegable y Pacchetto**
- 102 Fantasía**

Anexo

- 105 Accesorios**

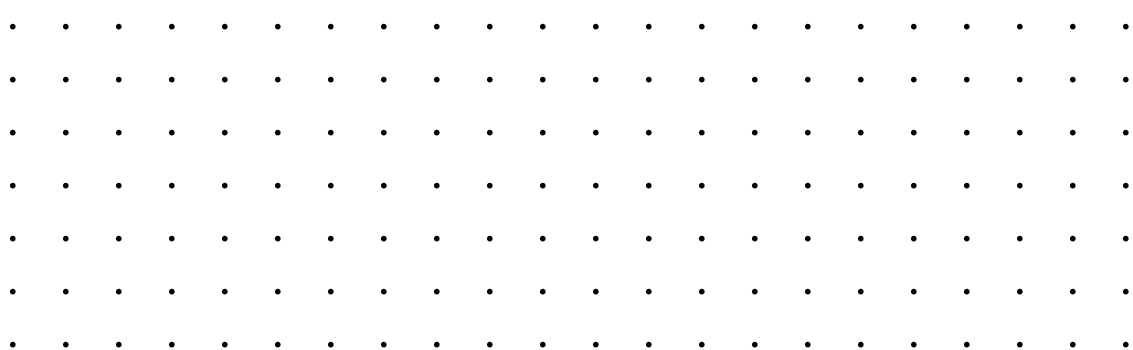

Tarifas Saxun

Accede al resto de tarifas Saxun en un clic.

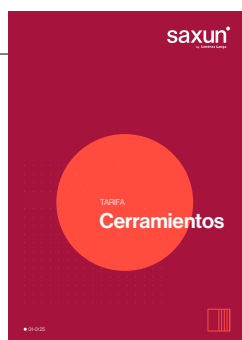

Venecianas

Aluminio y madera

Haz clic o escanea
para acceder a la ficha
de prescripción de
Venecianas





Venecianas de aluminio 16 y 25

Sistema cordón



Componentes

Nº	Cód.	Descripción	Nº	Cód.	Descripción
1	040028	Lama Veneciana de aluminio 25 mm	13	040013	Soporte rodete 25
2	040000	Lama Veneciana de aluminio 16 mm	14	040015	Varilla eje media luna
3	040002	Terminal cerrado 25 mm	15	040011	Bombo de 25
4	040007	Botón riel	16	040005	Tapón de cabezal de 25
5	040001	Cabezal 25	17	040006	Tapón riel de 25
6	040016	Soporte pared/techo	18	040004	Cordón Veneciana 1,4
7	040017	Soporte techo	19	040029	Esclerilla 25
8	040008	Maquinilla graduar	20	040021	Igualador cordón
9	040019	Gancho varilla mando	21	040030	Espaciador 25
10	040018	Varilla mando	22	040003	Esclerilla 16
11	040020	Terminal varilla y cordón	23	040014	Espaciador 16
12	040010	Maquinilla elevar	24	040022	Conector terminal



Venecianas de aluminio 16 y 25

Sistema motor

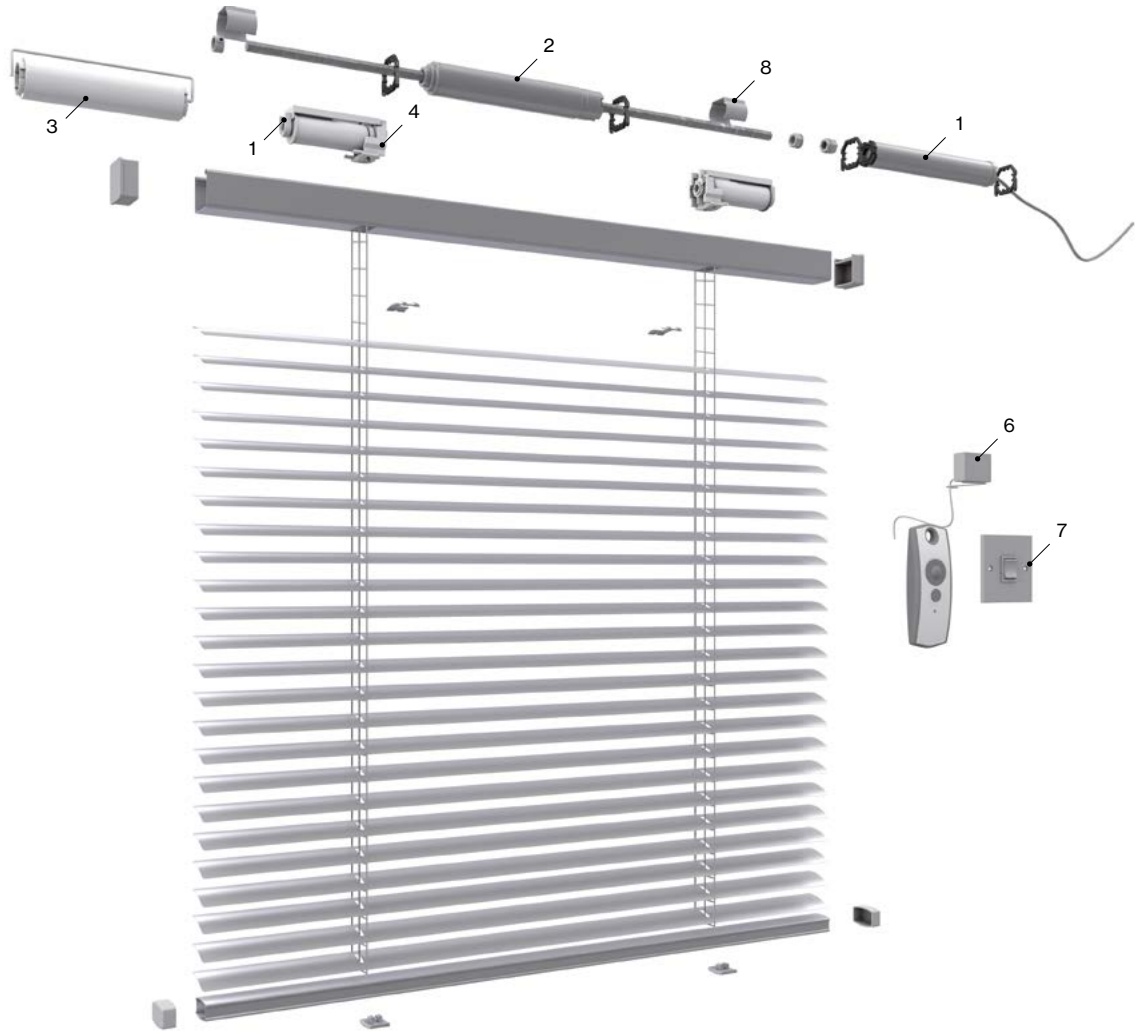

Componentes

Nº	Cód.	Descripción	Nº	Cód.	Descripción
1	502443	Motor LV25-B64	5	501785	Cono hexagonal largo CTS 25 6 mm
2	502733	Stop mecánico AMS25	6	502555	Transformador (1 motor)
3	501954	Integrated DC RTS receiver	7	501958	Interruptor
4	501851	Cubierta para cono largo CTS 25	8	040033	Soporte entre cristales

Medidas de fabricación

Máximos		Mínimos	
Ancho	-	Ancho	0,36 m
Alto	-	Alto	0,20 m



Venecianas de aluminio

Aluminio

	Precio € m ²		
	Lisos	Mates	Perforados
004101 Lama 16	76,00	-	-
004102 Lama 25	52,00	75,00	91,00
004403 Lama 50 escalerilla CLS	86,00	-	-
004404 Lama 50 cinta 38 mm CLS	95,00	-	-

• Mínimo a facturar 1m².

Incremento • Sistema Veneciana de aluminio

	Precio €
Combinación de colores (sólo 2 colores)	6,00 m² por cambio
Recortes	29,00 ud

Incremento • Veneciana de 16 y 25

	Precio € ud
040078 Escuadra de separación de 6 - 9,50 cm	7,00
040079 Escuadra de separación de 13 - 17 cm	8,00
030002 Sujeción sin tornillos a la ventana (Superior) • Blanco, gris, negro	13,00
030003 Sujeción sin tornillos a la ventana (Inferior) • Blanco, gris, negro	13,00

Tipo de mando

	Precio € ud
Mando varilla flexible entre cristales	17,00
Mando botón entre cristales	29,00
Monocomando a cadena a partir de 40 cm	68,00
Sujeción final	13,00
Guiada a cable	28,00

Mando varilla flexible entre cristales



Gradúa y eleva
Blanco

Mando botón entre cristales



Sólo gradúa
Gris • Negro

Monocomando a cadena a partir de 40 cm



Gradúa y eleva
Blanco • Gris • Negro
Mínimo fabricación 4m²

Sujeción final



Guiada a cable



Estándar



Venecianas de aluminio

Altura de paquete de recogida

Alto	Modelo de lama			
	Lama 16	Lama 25	Lama 50 escalerilla	Lama 50 cinta
30	6,00	5,00	8,00	9,00
60	7,00	6,00	9,00	10,00
80	8,00	7,00	10,00	11,00
100	9,00	7,00	11,00	12,00
120	10,00	8,00	12,00	13,00
140	10,00	8,00	12,00	13,50
160	11,00	9,00	13,00	14,50
180	12,00	9,00	13,00	15,50
200	13,00	10,00	14,00	16,00
220	14,00	10,00	15,00	17,00
240	15,00	11,00	15,00	17,50
260	-	11,00	16,00	18,50
280	-	12,00	17,00	19,00
300	-	12,00	17,50	20,50

Correspondencia de colores • Veneciana de 50

Modelo de lama	Sistema		
	Escalerilla	Cinta	Cordón 1,7
100	601	601	601
110	602	602	602
120	609	609	609
140	608	608	608
150	605	605	605
200	615	615	615
220	615	615	615

Altura de mando estándar

Alto cortina	Largo mandos
Hasta 1,50 m	5 cm menos
Hasta 1,50 a 2,80 m	1,50 m
Más de 2,80 m	2,00 m

• Medidas orientativas.

Colocación de los mandos para lama de 16 y 25

Ancho cortina	Posición de los mandos
De 16 a 22 cm	Mando al centro (sólo varilla)
De 23 a 35 cm	Mando ambos lados (C/D-V/I)
A partir de 36 cm	Mandos a un lado

Medidas de fabricación

Máximos	Modelo de lama			Mínimos	Modelo de lama		
	Lama 16	Lama 25	Lama 50 CLS		Lama 16	Lama 25	Lama 50 CLS
Ancho	3,00 m	3,00 m	2,70 m	Ancho	0,30 m	0,30 m	0,30 m
Alto	2,50 m	3,00 m	4,00 m	Alto	0,30 m	0,30 m	0,30 m

- Superficie máxima con motor 4,10 m²
- Ancho mínimo con receptor incorporado: 0,73 cm.
- Ancho mínimo sin receptor incorporado: 0,60 cm.
- Motorización, ver tarifa de motores. ☺



Venecianas de madera

Sistema cordón

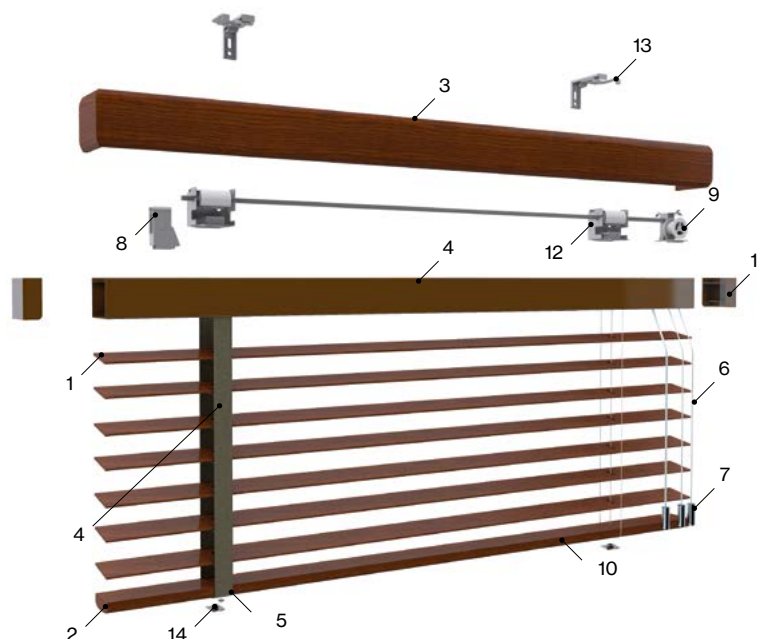

Componentes

Nº	Cód.	Descripción	Nº	Cód.	Descripción
1	004127	Lama Veneciana de madera 50 CLS Classic	8	004151	Freno cuerdas Veneciana 50 CLS
2	004126	Terminal Veneciana de madera 50 CLS Classic	9	004149	Regulador Veneciana 50 CLS
3	004128	Galería Veneciana de madera 50 CLS Classic	10	004137	Escalerilla cordón de 50 CLS
4	004135	Cabezal Veneciana de madera 50 CLS	11	004130	Tapón cabezal 50 CLS
5	004138	Cinta de 50 ancho 38 CLS	12	004152	Soporte bombo Veneciana 50 CLS
6	004168	Cordón 1,7 mm CLS	13	004154	Soporte cabezal techo pared CLS
7	004143	Tirador de aluminio Veneciana 50	14	004179	Placa fijación

Sistema motor



Componentes

Nº	Cód.	Descripción	Nº	Cód.	Descripción
1	004313	Soporte contera y motor Veneciana de madera	4	004310	Cono motor lama 50 mm
2	004309	Contera eje 42 octogonal	5	004146	Tubo octogonal de aluminio
3	004312	Bancada motor Veneciana de madera	6	-	Motor. La referencia dependerá del motor



Venecianas de madera

Madera CLS

		Precio € m ²	
		Classic	Bamboo
004350	Lama 50 CLS escalerilla	180,00	180,00
004355	Lama 50 CLS cinta de 38 mm	190,00	190,00

• Mínimo a facturar 1,25m².

Incremento • Sistema Veneciana de madera

	Precio € ud
Combinación de colores (sólo 2 colores)	6,00 m² por cambio
Recortes	29,00 ud

Incrementos

	Precio € ud
- Guía a cable	28,00
004247 Escuadra de separación (11-16 cm)	10,00
004248 Escuarar de separación (16-24 cm)	13,00

Correspondencia de colores

Colección	Lama	Escalerilla	Cinta	Cordón
Classic	300	601	601	510
	301	602	602	511
	302	603	603	554
	303	604	604	529
	304	606	606	527
	305	612	612	524
	306	612	612	524
	307	614	614	523
	308	615	615	532
	310	608	608	512
	312	609	609	533
	313	605	605	513
	314	610	610	513
	600	604	604	529
	601	612	612	524

Altura de paquete de recogida

Alto	Escalerilla	Cinta
100	16	17
120	17	19
140	19	20
160	21	23
180	22	24
200	23	26
220	24	28
240	25	30
260	28	31
280	30	34
300	31	37

Medidas orientativas en cm.

- Fabricación mínima con motor mecánico 0,65 y motor radio 0,65.
- Si no se indica lo contrario todos los modelos se fabrican con cinta.
- Posibilidad de motorizar con cinta y escalerilla (ver tarifa de Motores). ↓
- Medidas de fabricación: *Ancho máximo modelo classic 260.

Por favor, tenga en cuenta:

Una de las características de los productos de madera es que pueden variar los tonos, la veta o mostrar ondulaciones. A partir de 4 m² se recomienda utilizar sistema motor. Máximo con motor 7m².

Galerías

Estándar



Completa



Dentro de hueco



• Si deseas otra medida de lateral, especificar en el pedido.

Soportes

Soporte giratorio
004154



Soporte techo tipo "U"
004261



Soporte escuadra clip galería
004236



Estor enrollable

Haz clic o escanea para acceder a la ficha de prescripción

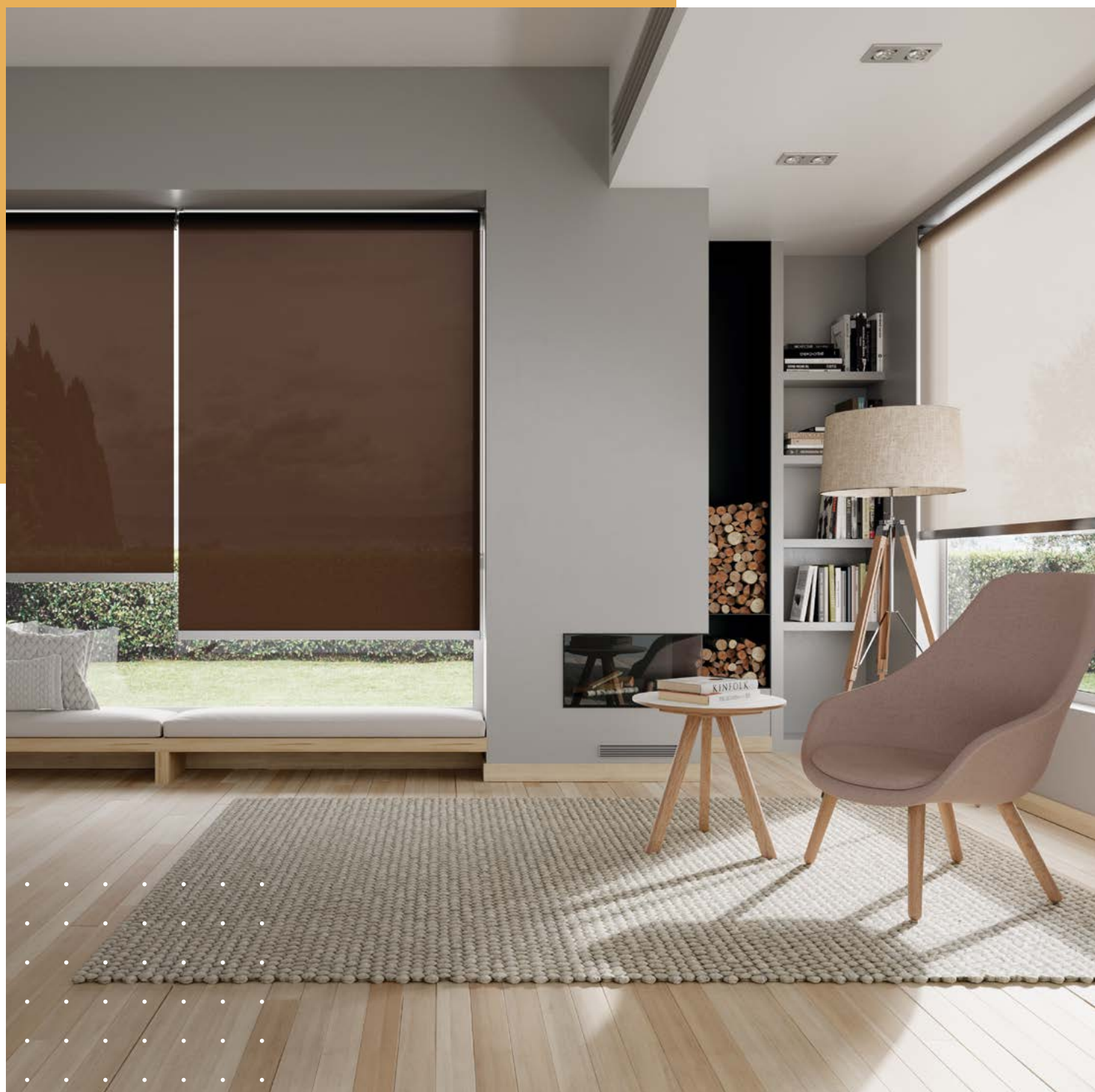



Estor enrollable Sistema a cadena

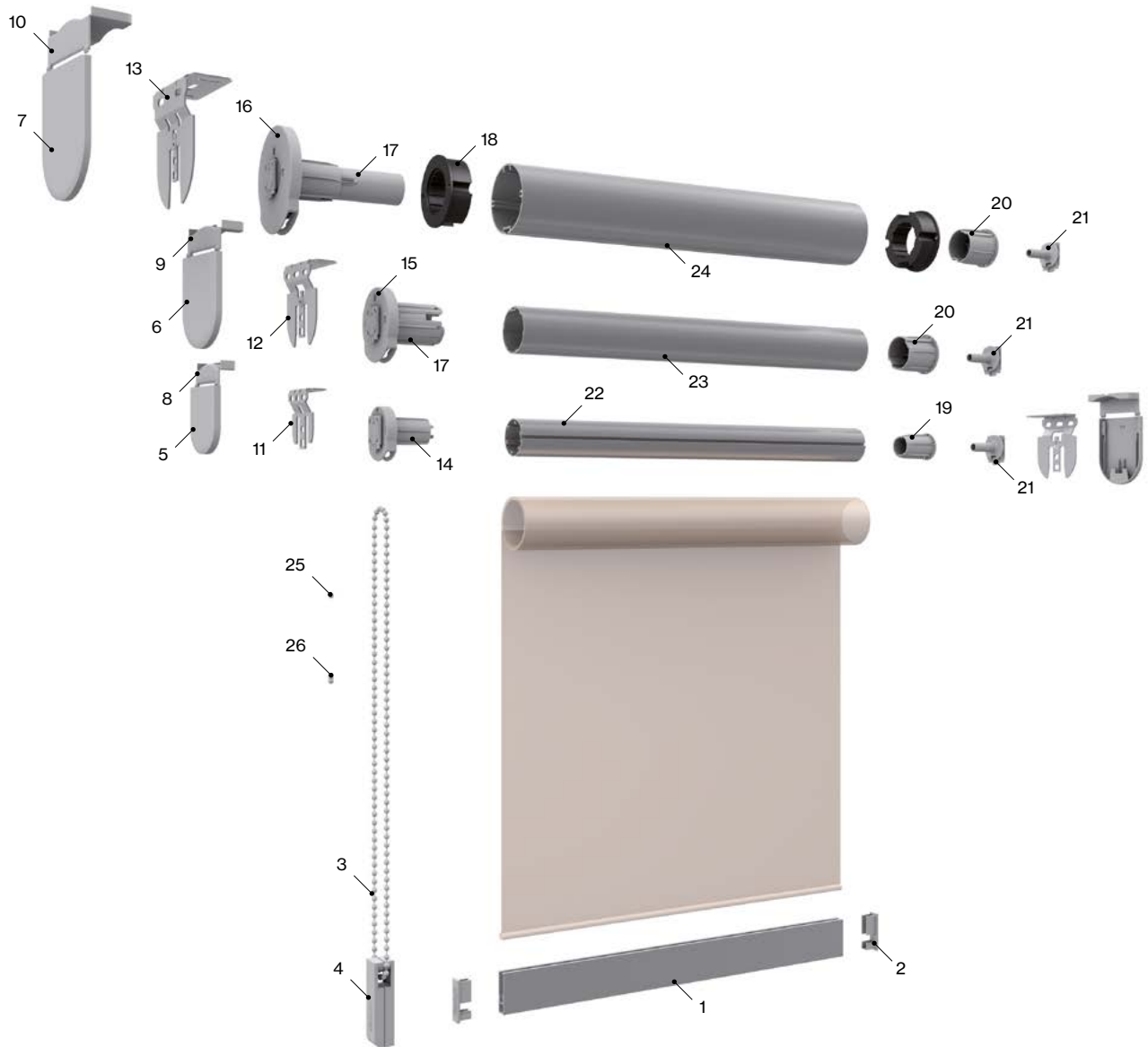

Componentes

Nº	Cód.	Descripción	Nº	Cód.	Descripción
1	030372	Terminal aluminio Slim	14	030918	Mecanismo Estor enrollable 1:1 S CLS
2	030424	Tapón terminal Slim	15	030803	Mecanismo Estor enrollable 1:1 M CLS
3	034024	Cadena 4,5x6 PVC	16	030844	Mec. Estor enrollable 1:3 L CLS desmultiplicador
4	030425	Tensor Slim L	17	030823	Adaptador tubo 43 CLS
5	030949	Tapa lateral soporte Estor enrollable S CLS	18	030867	Adaptador tubo 65 mm
6	030808	Tapa lateral soporte Estor enrollable M CLS	19	030919	Cápsula eje 35 CLS
7	030846	Tapa lateral soporte Estor enrollable L CLS	20	030806	Cápsula eje 43 CLS
8	030950	Tapa plástico tornillos soporte Estor enrollable S CLS	21	030801	Tope opuesto soporte metal Estor enrollable CLS
9	030809	Tapa plástico tornillos soporte Estor enrollable M CLS	22	030920	Tubo de aluminio 35
10	030847	Tapa plástico tornillos soporte Enrollable L CLS	23	031330	Tubo de aluminio 44
11	030948	Soporte metal Estor enrollable S CLS	24	030773	Tubo de aluminio 65
12	030807	Soporte metal Estor enrollable M CLS	25	030551	Tope bola cadena
13	030845	Soporte metal Estor enrollable L CLS	26	034037	Unión a cadena



Estor enrollable Sistema a cardán

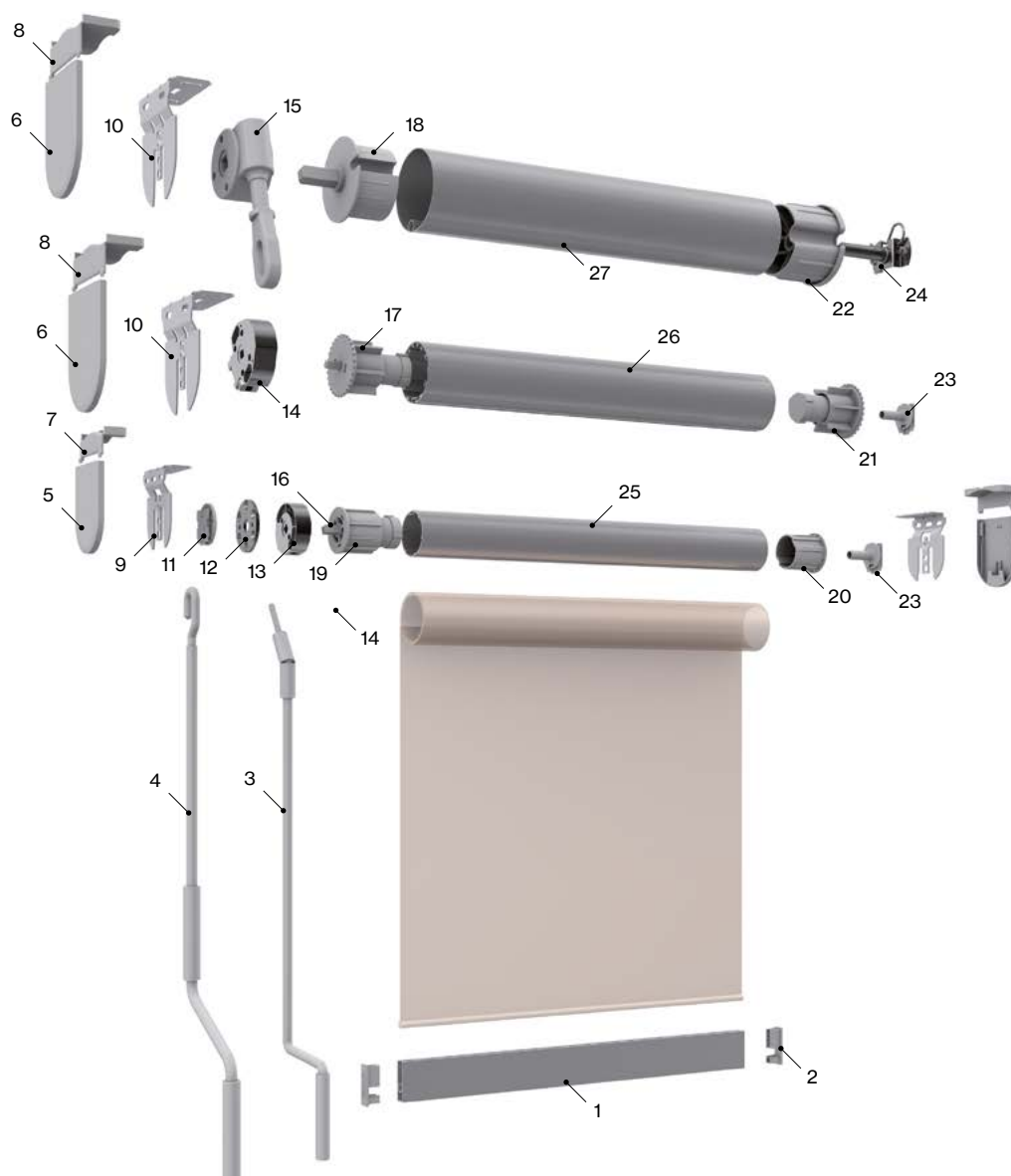

Componentes

Nº	Cód.	Descripción	Nº	Cód.	Descripción
1	030372	Terminal aluminio Slim	15	030193	Cardán eje 78
2	030424	Tapón terminal Slim	16	030561	Cápsula perno cuadrado cardán eje 43
3	030198	Manivela cardán	17	030562	Cápsula perno cuadrado cardán eje 50/60
4	030199	Manivela con gancho 1,80 (cardán-eje 78)	18	030563	Cápsula perno cuadrado cardán eje 78
5	030808	Tapa lateral soporte Estor enrollable M CLS	19	030823	Adaptador eje 43 CLS
6	030846	Tapa lateral soporte Estor enrollable L CLS	20	030806	Cápsula eje 43 CLS
7	030809	Tapa plástico tornillos soporte Estor enrollable M CLS	21	030536	Adaptador eje 50/60
8	030847	Tapa plástico tornillos soporte Estor enrollable L CLS	22	030538	Cápsula motor/cardán eje 78
9	030807	Soporte metal Estor enrollable M CLS	23	030801	Tope opuesto soporte metal Estor enrollable CLS
10	030845	Soporte metal Estor enrollable L CLS	24	030569	Perno soporte cápsula eje 78
11	030902	Sujeción motor eje 43 CLS	25	031330	Tubo aluminio 44
12	030934	Placa unión cardán-soporte CLS	26	030506	Tubo aluminio 60
13	030190	Cardán eje 43	27	022807	Tubo de enrollle 78
14	030176	Cardán eje 60			



Estor enrollable Sistema Saxun Box

Box 70 y 90 interior

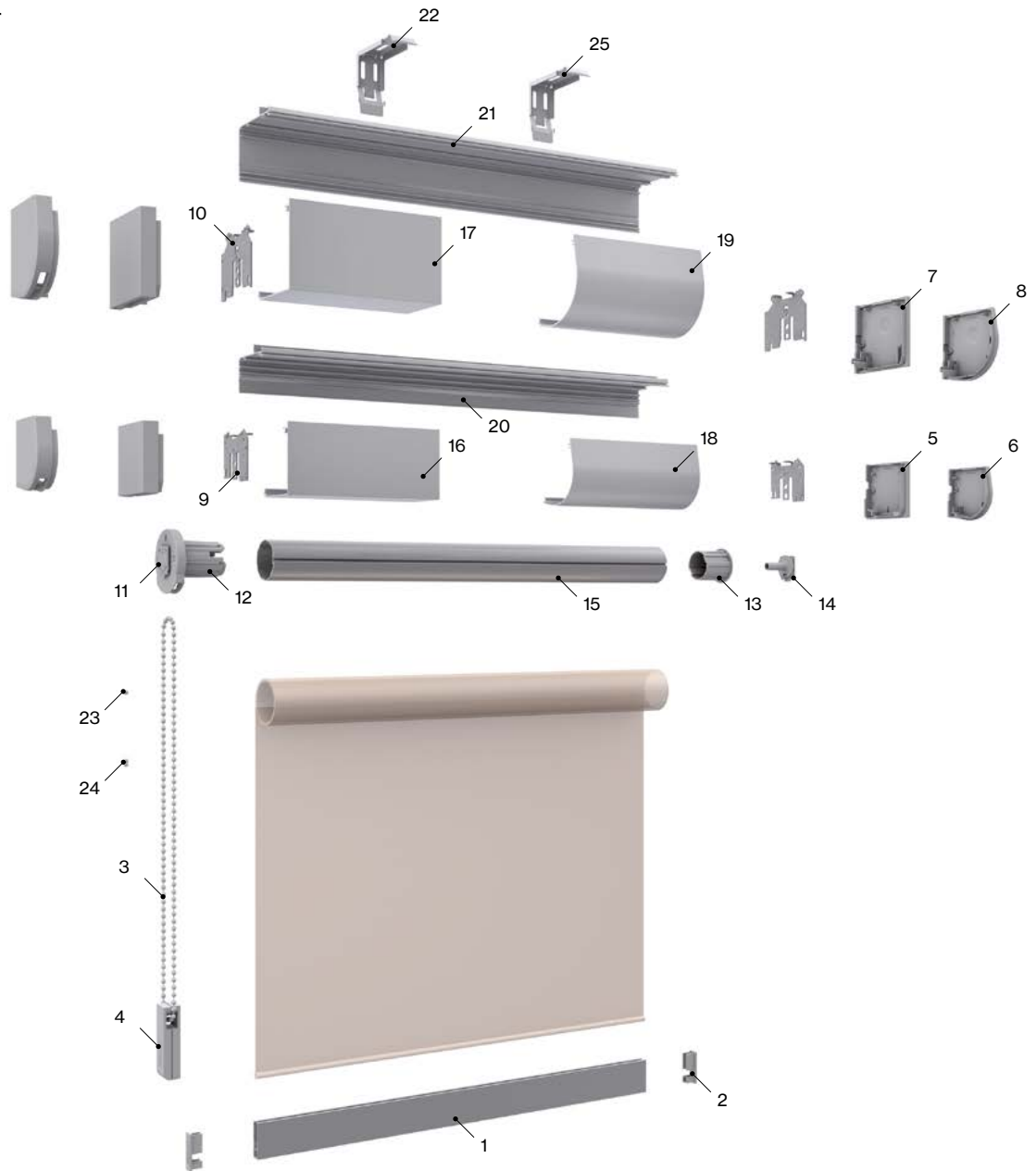

Componentes

Nº	Cód.	Descripción	Nº	Cód.	Descripción
1	030372	Terminal de aluminio Slim	14	030801	Tope opuesto soporte metal Estor enrollable CLS
2	030424	Tapón terminal Slim	15	031330	Tubo aluminio 44
3	034024	Cadena 4,5x6 PVC	16	030879	Tapa cajón S cuadrado
4	030425	Tensor Slim L	17	030826	Tapa cajón M cuadrado
5	030885	Tapa lateral cajón cuadrado S derecho	18	030880	Tapa cajón S redondo
6	030883	Tapa lateral cajón redondo S derecho	19	030827	Tapa cajón M redondo
7	030831	Tapa lateral cajón cuadrado M derecho	20	030877	Perfil base cajón S
8	030830	Tapa lateral cajón redondo M derecha	21	030824	Perfil base cajón M
9	030876	Jgo. soportes metal cajón Estor enrollable S	22	030821	Soporte instalación cajón M
10	030822	Jgo. soportes metal cajón Estor enrollable M	23	030551	Tope bola cadena
11	030803	Mecanismo Estor enrollable 1:1 M CLS	24	034037	Unión a cadena
12	030823	Adaptador tubo 43 CLS	25	030875	Soporte instalación S
13	030806	Cápsula eje 43 CLS			



Estor enrollable Sistema Saxun Box

Box 110 interior y exterior

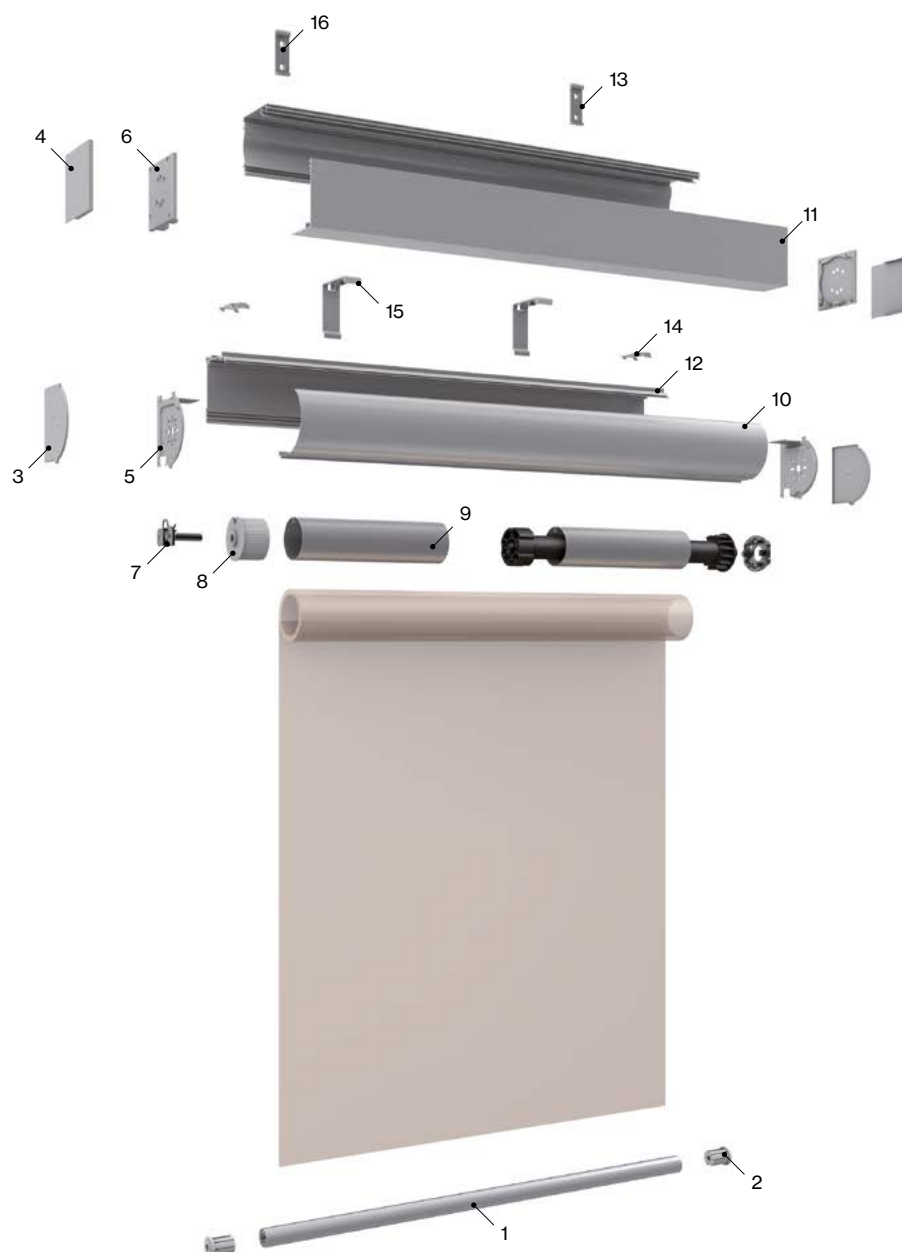

Componentes

Nº	Cód.	Descripción	Nº	Cód.	Descripción
1	030182	Terminal contrapeso sistema 110	9	022807	Tubo de enrollado 78
2	030320	Tapón terminal contrapeso sistema 110	10	004274	Cajón Saxun Box 110 perfil tapadera
3	030216	Jgo. embellecedor testero Saxun Box 110 redondo	11	030708	Perfil cofre inferior 110 cuadrado
4	030722	Jgo. embellecedor testero Saxun Box 110 cuadrado	12	004275	Cajón Saxun Box 110 perfil angular
5	030547	Jgo. testero metálico Saxun Box 110 redondo	13	030854	Perfil base cajón L
6	030721	Jgo. testero metálico Saxun Box 110 cuadrado	14	030540	Soporte techo Saxun Box 110
7	030569	Perno soporte cápsula eje 78	15	030542	Soporte pared Saxun Box 110
8	030538	Cápsula motor/cardán eje 78	16	022489	Jgo. soporte pared/techo cajón 110 cuadrado



Estor enrollable Sistema Rafter M y L

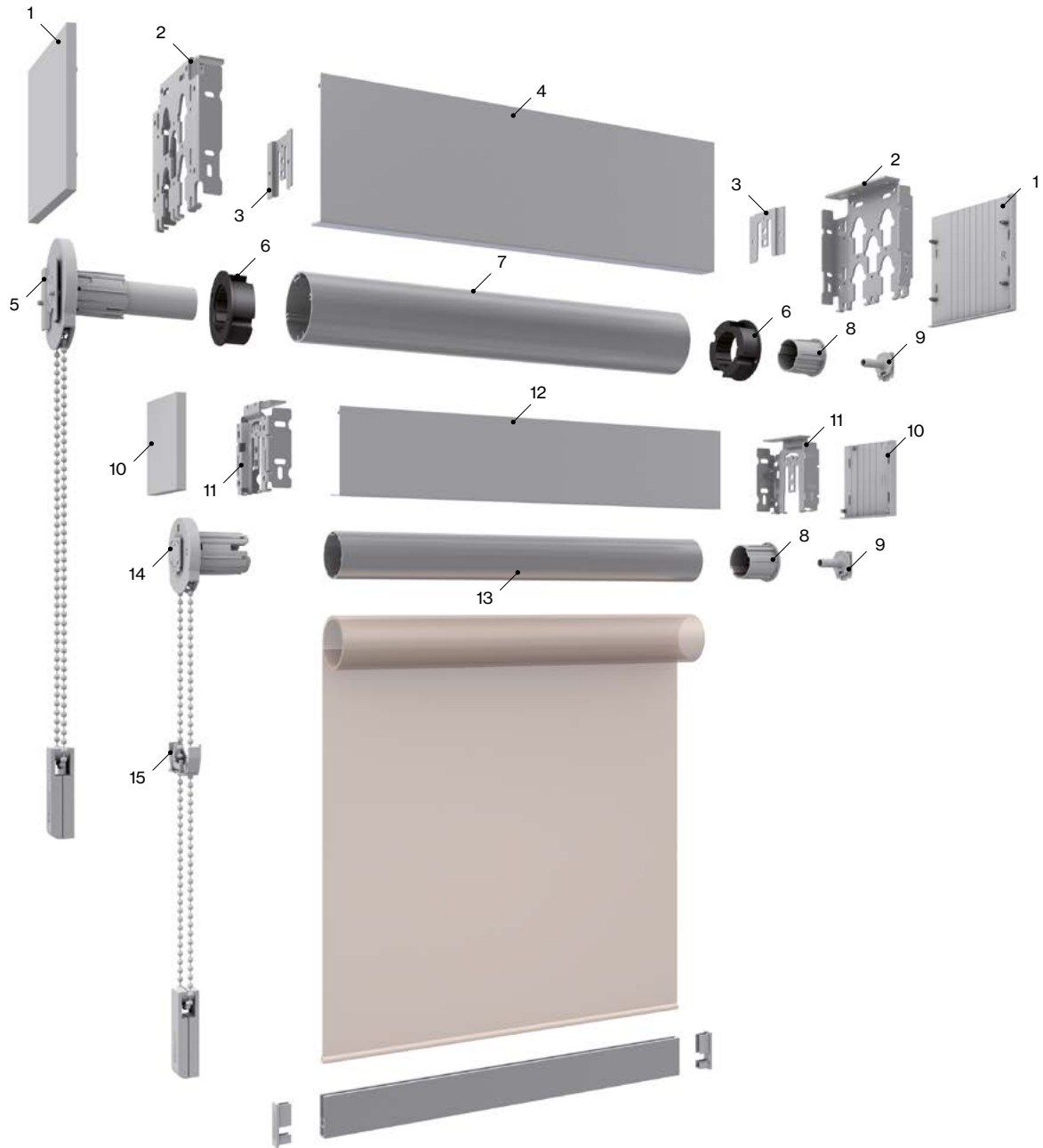

Componentes

Nº	Cód.	Descripción	Nº	Cód.	Descripción
1	031201	Jgo. tapadera PVC soporte Rafter L	9	030801	Tope opuesto soporte metal CLS
2	030998	Soporte metálico Rafter L	10	030995	Juego tapadera PVC soporte Rafter M
3	030999	Adaptador soporte Rafter L	11	030992	Soporte metálico Rafter M
4	031203	Perfil Rafter aluminio L	12	030997	Perfil Rafter aluminio M
5	030844	Mec. enrollable 1:3 L CLS desmultiplicador	13	031330	Tubo de aluminio 44 mm
6	030867	Adaptador tubo 65 mm	14	030803	Mecanismo Estor enrollable 1:1 M CLS
7	030773	Tubo de aluminio 65 mm	15	030996	Guiado mecanismo Rafter M
8	030806	Cápsula eje de 43 CLS			



Estor enrollable Sistema Rafter doble cortina

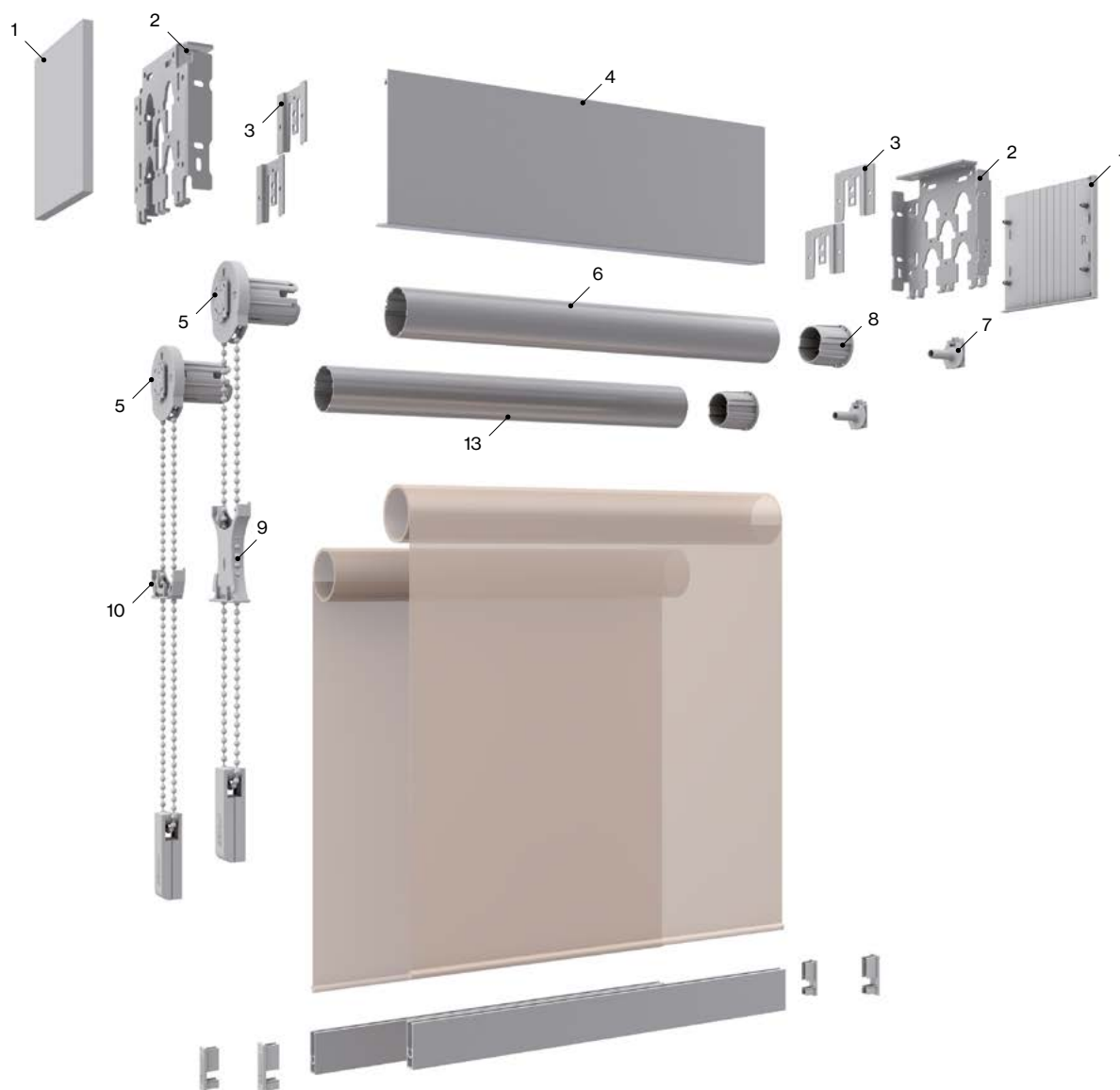

Componentes

Nº	Cód.	Descripción	Nº	Cód.	Descripción
1	031201	Jgo. tapadera PVC soporte Rafter L	6	031330	Tubo de aluminio 44 mm
2	030998	Soporte metálico Rafter L	7	030801	Tope opuesto soporte metal CLS
3	030999	Adaptador soporte Rafter L	8	030806	Cápsula eje de 43 CLS
4	031203	Perfil Rafter aluminio L	9	031202	Guiado mecanismo Rafter L
5	030803	Mecanismo Estor enrollable 1:1 M CLS	10	030996	Guiado mecanismo Rafter M



Estor enrollable Mínimo espacio entre Estores

Sistema enrollable a cadena



Sistema a cadena
Eje 44 y 65



Sistema a cadena central
Eje 44 y 65

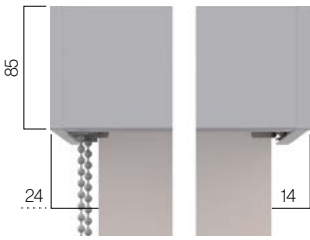

Sistema a cadena **Rafter M**
Eje 44

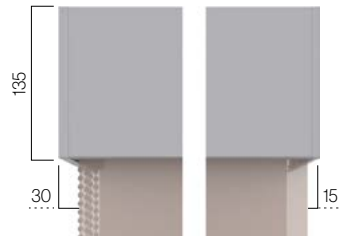

Sistema a cadena **Rafter L**
Eje 44 • Doble cortina

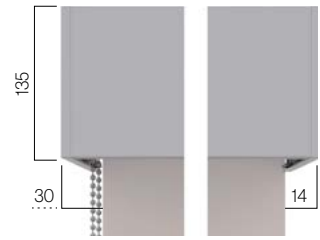

Sistema a cadena **Rafter L**
Eje 65

Sistema enrollable a cardán

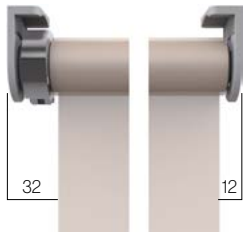

Sistema a cardán
Eje 44

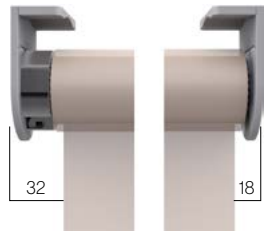

Sistema a cardán
Eje 60

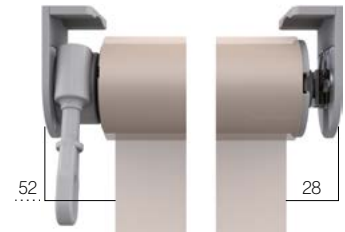

Sistema a cardán
Eje 78

Sistema Enrollable a motor

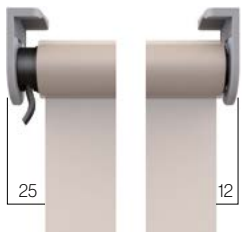

Sistema a motor
Eje 44

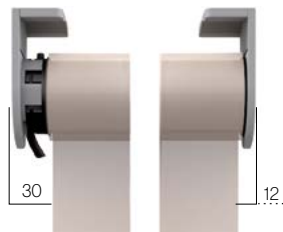

Sistema a motor
Eje 65



Sistema a motor
Eje 80

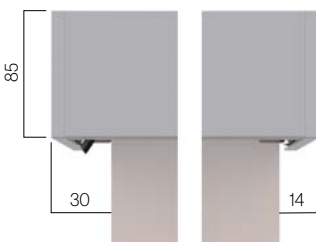

Sistema a motor **Rafter M**
Eje 44

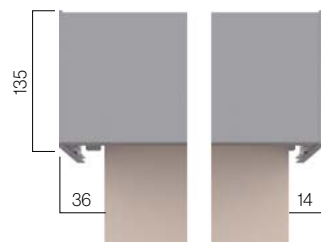

Sistema a motor **Rafter L**
Eje 65

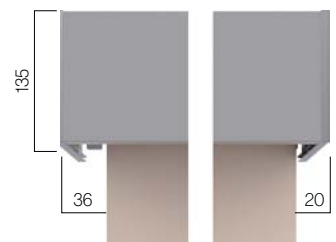

Sistema a motor **Rafter L**
Eje 80



Estor enrollable Opciones

Sistema CLS • Características y opciones según eje de enrollamiento

Características	Tamaño de ejes										
	Eje de 35 mm		Eje de 44 mm		Eje de 60 mm		Eje de 65 mm		Eje de 78 y 80 mm		
Ancho máximo	1,80 m		2,40 m		3,20 m		3,20 m		5,00 m		
Ancho mínimo	Cadena	0,40 m	Cadena	0,40 m	Motor	Mecánico = 0,65 m	Cadena	0,40 m	Motor	Mecánico = 0,74 m	
				Mecánico = 0,54 m							Vía radio = 0,82 m
	Motor	Mecánico = 0,40 m	Motor	Vía radio = 0,62 m	Cardán	0,40 m	Cardán	0,40 m	Cardán	0,40 m	
				Vía radio = 0,40 m						Batería = 0,75 m	
Batería = 0,63 m	Cardán	0,40 m									
Alto máximo	Depende del tejido		Depende del tejido		4,00 m		4,00 m		4,00 m		
Accionamiento	Cadena		Cadena		Motor	Vía radio	Cadena	Motor	Vía radio		
			Motor	Vía radio					Mecánico	Mecánico	
	Motor	Vía radio		Cardán	Snodo 90°	Cardán	0,40 m	Motor		Vía radio	Cardán
			Mecánico		Snodo 90° imantando				Articulación imantada		
Diámetro eje	35 mm		44 mm		60 mm		65 mm		78 mm		
Colores disponibles accesorios	Blanco, gris y negro		Blanco, gris y negro, marfil, grafito y marrón		Blanco, gris y negro, marfil, grafito y marrón		Blanco, gris y negro, marfil, grafito y marrón		Blanco, gris y negro, marfil, grafito y marrón		
Tipo de terminal	Slim, Plano, Ovalado y Redondo oculto		Slim, plano, ovalado y Redondo oculto		Slim, plano y redondo 110		Slim, plano y redondo 110		Slim, plano y redondo 110		
Tipo de mecanismo	1:1		1:1 y 1:3		-		1:3		-		
Tipo de cajón	70-90		70-90		90-110		90		110		
Tipo de soporte	S		M		L		L		L		
Tipo de guiado	Guiado Mini		Guiado Mini y plus		Guiado cable exterior		Guiado cable exterior		Guiado cable exterior		



Estor enrollable Cajones

Semicajón 70

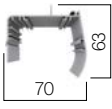

Box 70 Cuadrado

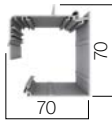

Box 70 Redondo



Semicajón 90

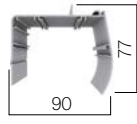

Box 90 Cuadrado

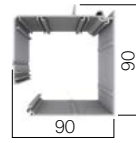

Box 90 Redondo



Box 110 Cuadrado

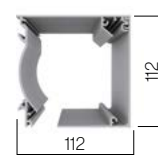

Box 110 Redondo



Enrollamiento de telas en cajón (altura máxima en m)

Modelo	Soportes	Cajón y semicajón 70		Cajón y semicajón 90			Cajón 110	
	Eje 35	Eje 35 Anchura máxima 1,80	Eje 44	Eje 44	Eje 60 Motor y cardán	Eje 65 Cadena	Eje 60	Eje 78
Shantung	2,20	2,95	1,60	5,00	4,00	3,50	-	-
Shantung-M1	2,20	2,95	1,80	5,00	4,00	3,50	-	-
Jávea	1,60	1,90	0,90	3,00	2,20	2,00	-	-
Brasilia	3,30	3,60	2,05	5,00	4,00	2,20	-	-
Altea	3,30	3,80	2,85	5,00	4,00	3,50	-	-
Casablanca	3,30	3,75	2,75	5,00	4,50	4,00	-	-
Bamboo	0,90	1,55	0,90	3,00	2,00	1,50	-	-
Calipso	3,00	3,80	1,90	3,80	2,00	1,60	-	-
Letho	0,80	1,40	0,80	2,50	1,20	0,90	-	-
Screen Nimbus	2,20	3,00	1,70	4,10	2,10	1,60	-	-
Stella	1,60	2,20	1,30	3,60	1,70	1,30	-	-
Azur	1,60	2,40	1,70	4,30	2,10	1,70	-	-
Julie	2,60	3,00	2,80	3,50	2,90	3,10	-	-
Tiore	2,20	2,80	2,10	3,00	2,20	2,00	-	-
Fobos	1,20	1,70	1,10	2,20	1,30	0,90	-	-
Atlas	0,70	1,20	0,70	1,80	1,20	0,90	-	-
Hiperion Black-Out	1,50	2,00	1,00	4,80	2,40	2,00	-	-
Hispa	3,50	4,10	3,10	4,40	3,60	3,20	-	-
Anae	3,00	3,50	2,75	4,40	3,50	3,10	-	-
Ariel	2,90	3,50	2,75	4,40	3,50	3,10	-	-
Jano	2,90	3,60	2,80	4,90	3,00	2,60	-	-
Deimos	2,20	3,00	2,50	4,00	3,20	2,80	-	-
Hidra	0,60	1,00	0,70	1,40	0,70	0,50	-	-
Cosmos	3,40	3,80	3,00	4,20	3,00	2,70	-	-
Cosmos Perla	2,90	3,20	1,60	4,60	2,30	1,90	-	-
Screen Kore	2,50	3,40	2,20	4,30	2,20	1,80	-	-
Leda Black-Out	3,50	4,00	2,60	7,00	4,00	2,80	-	-
Herse Black-Out	3,00	3,60	2,00	5,00	4,00	2,50	-	-
Umbriel	1,40	1,60	0,80	3,00	2,00	0,80	-	-
Tebe	1,70	2,00	1,00	3,60	2,50	1,00	-	-
Arce	2,00	2,40	1,60	4,00	3,00	1,80	-	-
Sax 3000	2,90	3,85	2,75	5,00	4,00	3,70	7,00	6,00
Mimo	1,60	2,35	1,45	3,00	2,50	2,30	6,00	5,00

* Incrementos, ver páginas 34 a 38.



Estor enrollable Cajones

Semicajón 70



Box 70 Cuadrado

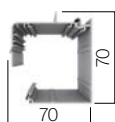

Box 70 Redondo



Semicajón 90

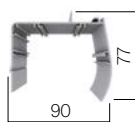

Box 90 Cuadrado

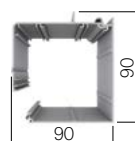

Box 90 Redondo



Box 110 Cuadrado

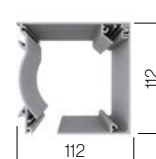

Box 110 Redondo

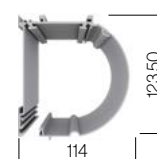

Enrollamiento de telas en cajón (altura máxima en m)

Modelo	Soportes	Cajón y semicajón 70		Cajón y semicajón 90			Cajón 110	
	Eje 35	Eje 35 Anchura máxima 1,80	Eje 44	Eje 44	Eje 60 Motor y cardán	Eje 65 Cadena	Eje 60	Eje 78 y 80
Black-Out	2,20	2,95	1,75	5,00	4,00	3,60	7,00	7,00
Berlín Black-Out	1,90	2,55	1,65	4,50	2,50	2,10	7,00	7,00
Dartex Black-Out	1,70	2,15	1,25	5,30	2,60	2,30	6,00	4,20
Soltis 99	2,70	3,40	2,50	5,00	2,40	2,20	7,00	6,00
Soltis Horizon 86	2,00	3,05	1,70	6,00	3,20	2,60	7,00	5,00
Soltis Perform 92	1,90	3,35	2,25	6,00	3,50	2,20	7,00	5,00
Soltis Opaque B92	1,40	2,05	1,25	5,00	2,80	2,10	5,50	4,10
Screen 8505	1,70	3,20	1,90	4,00	3,00	2,40	7,00	5,50
Screen 2165	1,10	1,80	1,05	3,30	1,90	1,50	6,00	4,10
Sax Screen 3600 1%	1,20	1,85	1,20	4,80	2,80	2,20	5,50	5,00
Sax Screen 3600 5%	1,60	1,85	1,30	4,90	3,00	2,40	6,00	5,50
Sax Screen 3600 10%	1,70	1,85	1,30	4,90	3,00	2,40	6,00	5,50
Sax Screen 5500 1%	1,10	1,45	0,90	3,50	2,00	1,50	4,80	3,50
Sax Screen 5500 3%	1,30	1,55	0,90	3,50	2,00	1,50	4,80	3,50
Sax Screen 5500 5%	1,40	1,65	0,90	3,80	2,20	1,80	5,00	3,90
Sax Screen 5500 10%	1,40	1,65	1,10	3,80	2,20	1,80	5,00	3,90
Screen Artemis 1%	2,20	3,00	1,90	4,00	2,10	2,00	6,10	6,80
Screen Artemis 3%	2,10	3,10	2,00	4,10	2,30	2,00	6,30	6,90
Screen Artemis 5%	2,30	3,20	2,10	4,30	2,50	2,10	6,50	7,00
Screen Elarus Black-Out	1,50	2,20	1,60	2,80	1,90	1,40	6,00	4,00
Soltis Harmony 88	2,60	3,20	2,50	4,60	3,40	2,90	6,00	7,00
Soltis Lounge 96	2,40	3,00	2,25	6,00	3,50	2,20	7,00	5,00
Soltis Proof W96	1,60	2,25	1,05	4,00	2,80	2,30	6,50	5,00
Screen Titan	1,90	2,60	1,80	3,10	1,70	1,30	6,00	4,00
Screen Opaque 622	1,00	1,65	0,90	3,80	2,20	1,80	5,00	3,90
Sax Screen Dione	2,10	2,00	1,00	3,60	2,50	1,00	4,80	3,50



Estor enrollable Soportes y terminales

Soportes

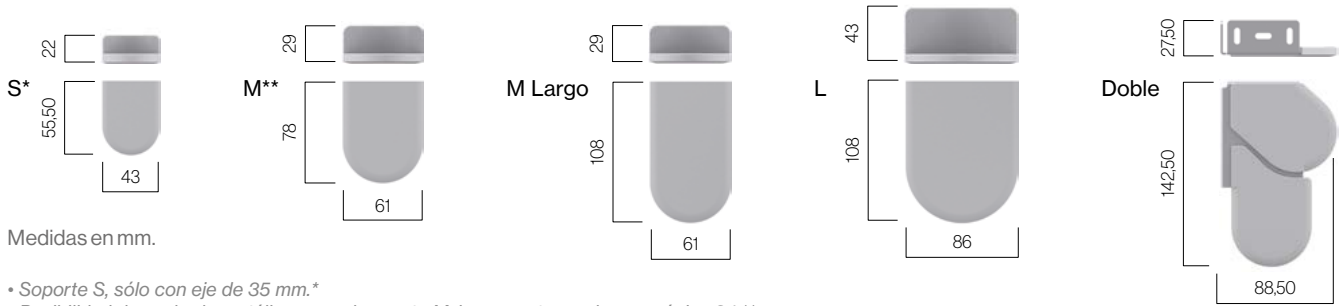

Medidas en mm.

- Soporte S, sólo con eje de 35 mm.*
- Posibilidad de acabado metálico para el soporte M, incremento y color ver página 34.**

Soportes • Acabados

	Blanco	Marfil	Gris	Negro	Marrón	Grafito
Mecanismo eje 35 (S)	●		●	●		
Mecanismo eje 44 (M)	●	●	●	●	●	●
Mecanismo eje 60 (Motor)	●	●	●	●	●	●
Mecanismo eje 65	●	●	●	●	●	●
Mecanismo eje 78 (L)	●	●	●	●	●	●
Soporte doble	●	●	●	●	●	●

Terminales

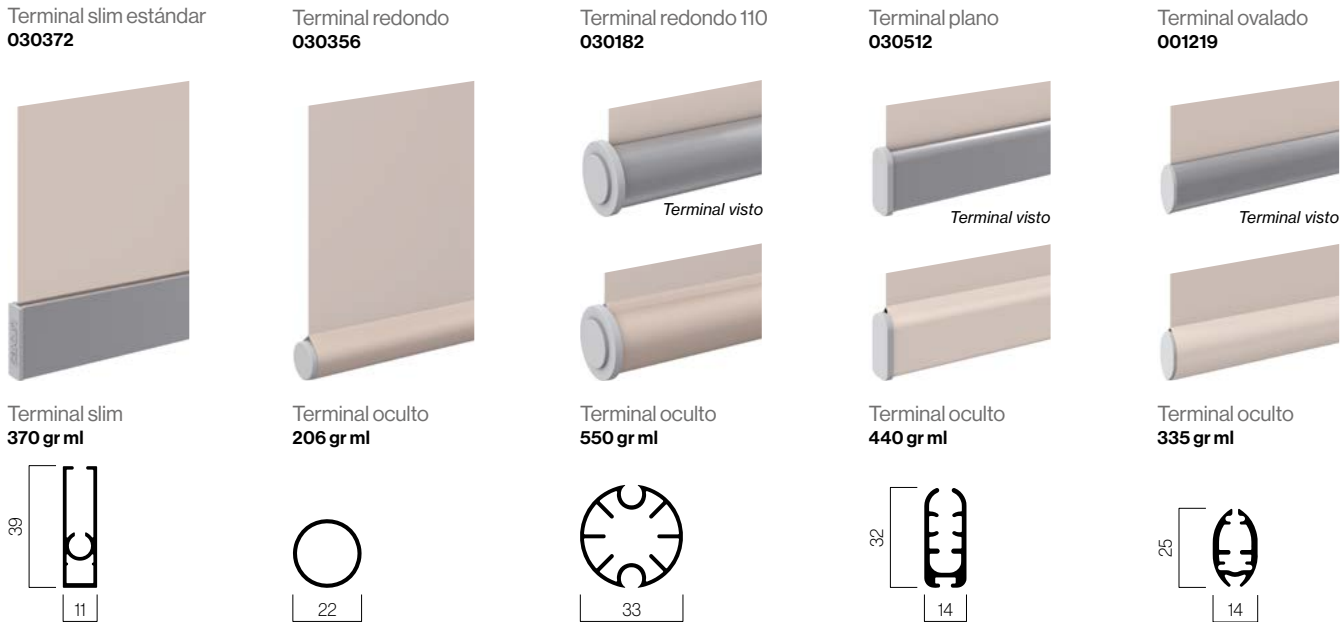

Medidas en mm.

Terminales • Acabados

	Blanco	Plata	Marfil	Gris	Negro	Marrón	Grafito
Terminal slim	●	●	●	●	●	●	●
Terminal plano	●	●	●	●	●	●	●
Terminal ovalado	●	●	●	●	●	●	●
Terminal redondo	●			●	●		
Terminal redondo 110	●					●	



Estor enrollable Guías y terminales

Guías interiores

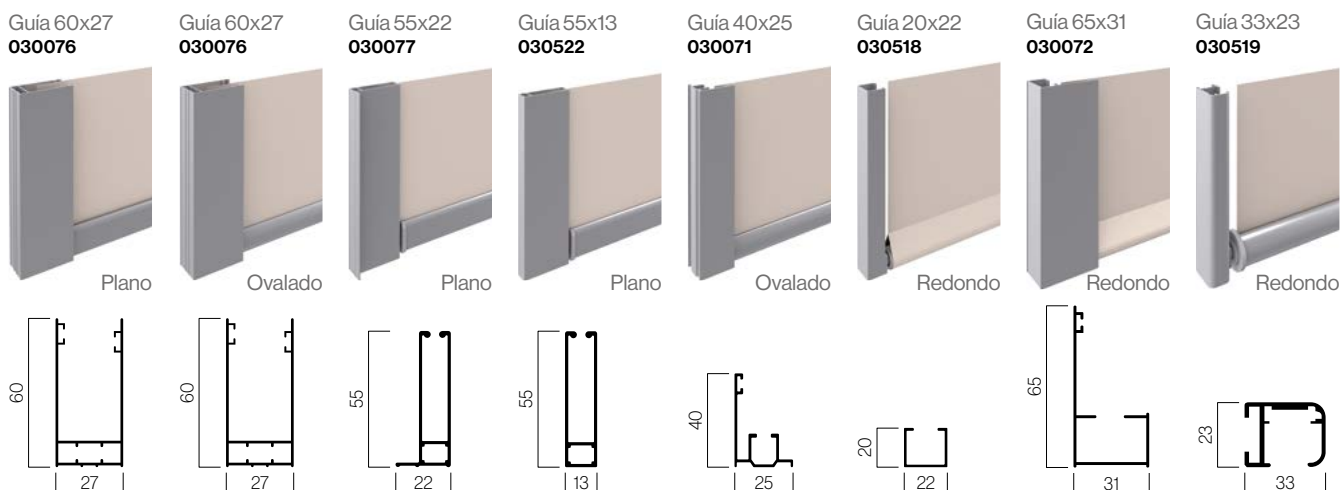

Medidas en m.

- Las guías 40x25 y 20x22 no son compatibles con cajón.
- Incrementos, ver páginas de 34 a 38.

Sistemas guiados

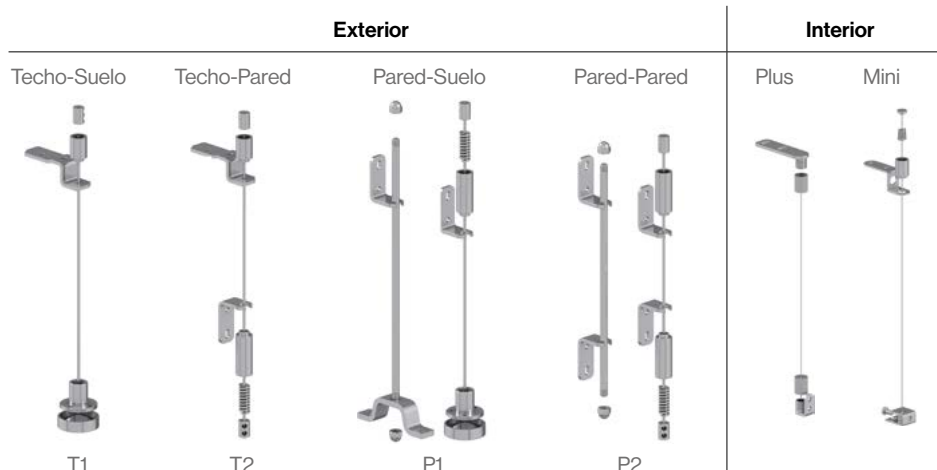

Accesorios

Barra estabilizadora 12x62,50
030894

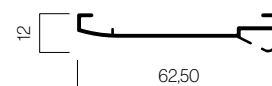

- Colores disponibles en blanco y en plata.

Terminales con Cable



Compatibilidad de terminales y guías

Terminales	Guías						
	65x31 mm	60x27 mm	55x22 mm	55x13 mm	40x25 mm	33x23 mm	20x22 mm
Terminal slim		•					
Terminal plano		•	•	•			
Terminal ovalado		•			•		
Terminal redondo	•						•
Terminal redondo 110						•	



Estor enrollable Incrementos

Incremento • Cajón

Blanco	Precio € ml
Semicajón 70	25,00
Cajón Saxun Box 70	46,00
Cajón Saxun Box 70 redondo	46,00
Semicajón 90	44,00
Cajón Saxun Box 90	57,00
Cajón Saxun Box 90 redondo	57,00
Cajón Saxun Box 110	108,00
Cajón Saxun Box 110 redondo	108,00

• Estos precios incluyen cajón y testeros.

Incremento • Lacado de perfiles

	Precio € ml		
	Plata y RAL norm.	Anodizado	Lacado madera
Semicajón 70 y 90	22,00	-	47,00
Cajón Saxun Box 70 y 90	35,00	-	67,00
Cajón Saxun Box 110	35,00	53,00	67,00

• Mínimo a facturar 1 ml.

Incremento • Guías

Blanco	Precio € ml
Juego de guías 60x27	39,00
Juego de guías 55x22	41,00
Juego de guías 55x13	37,00
Juego de guías con pala 40x25	25,00
Juego de guías 20x22	18,00
Juego perfil compensador	25,00
Barra estabilizadora eje de 43	12,00
Juego de guías con pala 65x31	32,00
Juego de guías 33x23	38,00

Incremento • Lacado de perfiles

	Precio € ml		
	Plata y RAL norm.	Anodizado	Lacado madera
Juego de guías	26,00	36,00	47,00
Barra estabilizadora	16,00	25,00	29,00
Terminal	16,00	25,00	29,00

• Mínimo a facturar 1 ml.



Estor enrollable Incrementos

Incremento • Sistema de elevación a cadena

	Relación	Precio € ud
Cardán con eje de 44	3:1 - 6 kg máx.	51,00
Cardán con eje de 60	5:1 - 17 kg máx.	68,00
Cardán con eje de 78	-	74,00
Articulación imantada	-	40,00
Articulación fija	-	21,00
Snodo 90° manivela fija	-	41,00
Snodo 90° imantada	-	63,00
Manivela con gancho eje 78 <i>Blanco, gris, marrón y negro</i>	-	23,00
Manivela con cardán estándar 1,60 - 1,80 - 2,00 - 2,60 <i>Blanco, gris, marrón y negro</i>	-	41,00

* Para el sistema a manivela hay que añadir al coste del Estor el precio del cardán, del snodo y de la manivela, teniendo en cuenta el tipo de eje necesario.

Incremento • Sistema de guiado por cable

	Precio € ud
Guía a cable interior mini	22,00
Guía a cable interior plus	69,00
Guía a cable exterior inox	165,00
Guía con varilla de acero	180,00

Incremento • Sistema de elevación a cadena

	Precio € ud
A cadena eje de 65 . Cambio de eje de 44 a 65	48,00

Incremento • Mecanismos tela cliente

Eje	Ancho													
	0,60	0,80	1,00	1,20	1,40	1,60	1,80	2,00	2,20	2,40	2,60	2,80	3,00	3,20
44-35	52	58	62	68	72	78	82	86	92	97	-	-	-	-
65	70	76	84	91	97	103	110	117	123	130	136	144	152	159

• A efectos de precio se redondeará a la inmediata superior.
• El mecanismo para otros tejidos que no sean de Saxun incluye: mecanismo, eje, soportes, cadena y terminal.

Por favor, tenga en cuenta:

Saxun no puede garantizar el buen funcionamiento del sistema con otros tejidos que no sean de Saxun.



Estor enrollable Incrementos

Incremento • Accesorios

	Precio €
Soporte central	Sin incremento
Soporte doble cortina. <i>Solo eje de 44</i>	Sin incremento
Juego de soportes metálicos <i>Blanco, aluminio, cromo, inox, negro níquel, oro viejo</i> <i>Incluye soportes, cadena metálica, mecanismo</i>	101,00 jgo
Sistema Velia. <i>Solo eje de 44. Sistema accionamiento mediante tirador</i>	34,00 ud



Incremento • Accesorios

	Precio €
030553 Cadena metálica	3,50 ml
030285 Sujeción sin tornillos enrollables • Superior <i>Blanco, gris, negro</i>	13,00 ud
030003 Sujeción sin tornillos enrollables • Inferior <i>Blanco, gris, negro</i>	13,00 ud
034048 Escuadra separación de 10 cm <i>Blanco, gris, negro, marrón, marfil</i>	5,00 ud
034049 Escuadra separación de 14 cm <i>Blanco, gris, negro, marrón, marfil</i>	5,50 ud
034052 Escuadra separación de 21 cm <i>Blanco, gris, negro</i>	6,00 ud

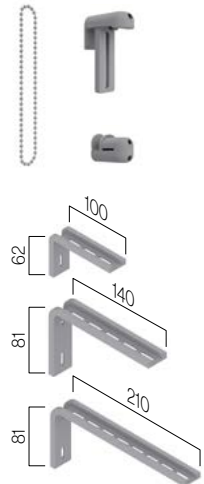

Incremento • Impresión digital

	Precio € m ²
Tejidos impresión digital (mínimo 1,50 m ²) Sobre el precio	65,00
Sax 3000, Sax Screen 5500 1% 5%, Sax Screen 3600 1% 5%, Black-Out, Screen Titan	

- Sólo sobre tejidos blancos.
- Este incremento se sumará al precio del Estor en el tejido elegido.

Incremento • Sistema Rafter

	Precio € ml		
	Blanco	Plata y RAL norm.	Lacado madera
Sistema Rafter M	32,00	38,00	51,00
Sistema Rafter L	48,00	55,00	67,00

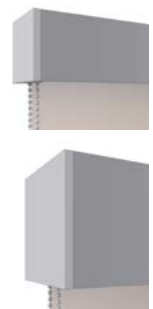

- Mínimo a facturar: 1 ml.
- Accesorios en color blanco, plata y negro





Estor enrollable Incrementos de tejidos

En la siguiente tabla se puede ver el precio del tejido por metro sin confeccionar. Y observar las dimensiones máximas de fabricación según la orientación del tejido.

Incremento • Confección del tejido

Tejidos confeccionados	Precio € m ²
	14,00

Incrementos

Código	Tejido	Precio € m ²	Ancho rollo	Sin termosoldadura	Con termosoldadura
					
				Alto x Ancho	Alto x Ancho
030497	Sax 3000	20,00	2,00	3,00x2,00	1,80x2,40
030497	Sax 3000	20,00	2,40	3,00x2,40	2,20x2,40
031027	Shantung	20,00	2,00	3,00x2,00	-
031064	Mimo R	25,00	2,70	3,00x2,70	-
031028	Shantung-M1	32,00	2,00	3,00x2,00	-
031014	Filtro solar	51,00	1,80	3,00x1,80	1,60x2,40
031021	Bamboo	51,00	2,30	3,00x2,00	-
031101	Jávea	70,00	3,00	3,00x2,80	-
031102	Brasilia	70,00	2,80	3,00x2,80	-
031104	Altea	51,00	2,40	3,00x2,40	-
031105	Casablanca	45,00	2,80	3,00x2,80	-
030680	Sax Screen 3600 1%	45,00	3,00	4,00x3,00	2,70x5,00
030680	Sax Screen 3600 5%	45,00	3,00	4,00x3,00	2,70x5,00
030680	Sax Screen 3600 10%	45,00	2,50	4,00x2,50	2,20x5,00
031006	Sax Screen 5500 1%	51,00	2,50	4,00x2,50	2,20x5,00
031006	Sax Screen 5500 3%	51,00	3,00	4,00x3,00	2,70x5,00
031006	Sax Screen 5500 5%	51,00	3,00	4,00x3,00	2,70x5,00
031006	Sax Screen 5500 10%	51,00	2,50	4,00x2,50	2,20x5,00
031001	Black-Out	32,00	1,80	4,00x1,80	1,50x5,00
031001	Black-Out	32,00	3,00	4,00x3,00	2,70x5,00
031069	Berlín Black-Out	32,00	2,40	4,00x2,40	2,20x3,60
030338	Darktex Black-Out	38,00	3,00	4,00x3,00	2,60x3,60
031007	Screen 8505	58,00	2,50	4,00x2,50	2,20x5,00
031010	Screen 2165	58,00	2,50	4,00x2,50	2,20x5,00
030698	Soltis 99	45,00	1,77	4,00x1,77	1,45x5,00
030698	Soltis 99	45,00	2,67	4,00x2,67	2,35x5,00
031082	Soltis 86	63,00	1,77	4,00x1,77	1,45x5,00
031082	Soltis 86	63,00	2,67	4,00x2,67	2,35x5,00
030977	Soltis 88	58,00	1,77	4,00x1,77	1,45x5,00
030977	Soltis 88	58,00	2,67	4,00x2,67	2,35x5,00
031024	Soltis 92	89,00	1,77	4,00x1,77	1,45x5,00
031024	Soltis 92	89,00	2,67	4,00x2,67	2,35x5,00
031063	Soltis 96	58,00	2,67	4,00x2,67	2,35x5,00
031094	Soltis Proof W96	63,00	2,67	4,00x2,67	2,35x5,00

• Tejido mínimo a facturar 1 ml.

• Precios para metro (tejido sin confeccionar).

• El corte del tejido sin confeccionar será del ancho de rollo.

• Cuando la medida de la cortina supere los anchos indicados de cada tejido, los empalmes se realizarán en horizontal.





Estor enrollable Incrementos de tejidos

En la siguiente tabla se puede ver el precio del tejido por metraje sin confeccionar. Y observar las dimensiones máximas de fabricación según la orientación del tejido.

Incremento • Confección del tejido

Tejidos Confeccionados	Precio € m ²
	14,00

Incrementos

Código	Tejido	Precio € m ²	Ancho rollo	Sin termosoldadura	Con termosoldadura
					
				Alto x Ancho	Alto x Ancho
					
				Alto x Ancho	Alto x Ancho
030970	Titan	58,00	3,20	4,00x3,20	2,90x5,00
030420	Soltis B92 Black-Out	127,00	1,70	4,00x1,70	1,40x5,00
031111	Ariel	51,00	2,80	3,00x2,80	-
031112	Hispa	63,00	2,30	3,00x2,20	-
031113	Jano	51,00	2,80	3,00x2,80	-
031115	Anae	63,00	2,30	3,00x2,20	-
031116	Deimos	20,00	2,90	3,00x2,80	-
031119	Stella	63,00	2,50	3,00x2,40	-
031120	Azur	51,00	2,50	3,00x2,40	2,20x2,80
031127	Calipso	20,00	2,70	3,00x2,60	2,40x2,80
031128	Fobos	25,00	2,50	3,00x2,40	-
031130	Letho	51,00	2,50	3,00x2,40	-
031134	Screen Nimbus	70,00	2,50	4,00x2,40	2,20x2,80
031136	Tiore	25,00	2,50	3,00x2,40	-
031137	Screen Kore	70,00	2,50	3,00x2,40	-
031138	Cosmos	51,00	2,70	3,00x2,60	2,40x2,80
031139	Cosmos Perla	70,00	2,35	3,00x2,30	2,10x2,80
031140	Hidra	70,00	3,00	3,00x2,80	-
031142	Atlas	51,00	2,80	3,00x2,80	-
031143	Hiperion Black-Out	70,00	3,00	3,00x2,80	-
031144	Screen Artemis 1%	51,00	3,10	4,00x3,00	-
031144	Screen Artemis 3%	51,00	3,10	4,00x3,00	-
031144	Screen Artemis 5%	51,00	3,10	4,00x3,00	-
031145	Scr. Elarus Black-Out	127,00	2,10	4,00x2,10	1,80x4,00
031285	Leda Black-Out	25,00	2,00	3,00x2,00	-
031286	Herse Black-Out	25,00	2,80	3,00x2,80	-
031287	Umbriel	70,00	2,80	3,00x2,80	-
031288	Tebe	51,00	3,00	3,00x2,80	-
031289	Arce	25,00	2,60	3,00x2,60	-
031291	Sax Screen Dione	70,00	3,00	4,00x3,00	2,70x5,00

• Tejido mínimo a facturar 1 ml.

• Precios para metraje (tejido sin confeccionar).

• El corte del tejido sin confeccionar será del ancho de rollo.

• Cuando la medida de la cortina supere los anchos indicados de cada tejido, los empalmes se realizarán en horizontal.



Estor enrollable

Sax 3000 • Shantung • Deimos • Calipso

Precio € ud												
Alto	Sistema a cadena Eje de 44										Sistema Eje de 60 y 65	
	0,60	0,80	1,00	1,20	1,40	1,60	1,80	2,00	2,20	2,40	2,60	2,80
1,00	75	83	92	100	109	117	127	135	143	152	161	169
1,20	77	86	97	105	115	124	133	141	152	161	169	178
1,40	79	91	100	112	121	131	140	151	161	171	181	191
1,60	83	93	104	115	127	137	148	159	169	179	190	200
1,80	86	98	110	121	133	143	155	168	178	191	204	216
2,00	90	101	114	127	138	151	162	176	189	200	212	223
2,20	92	105	117	131	144	156	171	185	197	210	224	238
2,40	95	109	123	137	151	163	177	192	206	219	231	244
2,60	98	113	128	141	155	171	186	200	214	229	244	260
2,80	101	116	131	148	162	177	192	209	224	238	252	266
3,00	104	121	137	152	168	185	200	216	232	248	263	278

Características de los tejidos

Tejido	Ancho de rollo (ml)	Sin termosoldadura		Con termosoldadura
		Alto x Ancho	Alto x Ancho	Alto x Ancho
030497 Sax 3000	2,00	3,00x2,00	1,80x2,40	-
031027 Shantung	2,00	3,00x2,00	-	-
031116 Deimos	2,90	3,00x2,80	-	-
031127 Calipso	2,70	3,00x2,60	2,40x2,80	-

• Sax 3000 Ancho de rollo de 2,40 para las referencias: 2100, 2101, 2102, 2104, 2105, 2110, 2111, 2126, 2136, 2137.

Mimo R • Fobos • Tiore • Shantung-M1 • Leda Black-Out • Herse Black-Out • Arce

Precio € ud												
Alto	Sistema a cadena Eje de 44										Sistema Eje de 60 y 65	
	0,60	0,80	1,00	1,20	1,40	1,60	1,80	2,00	2,20	2,40	2,60	2,80
1,00	86	99	112	122	135	144	156	169	179	192	204	215
1,20	92	105	117	131	143	156	171	182	197	209	222	236
1,40	97	112	127	139	154	168	182	198	212	227	239	254
1,60	101	117	133	150	163	179	197	212	228	243	258	275
1,80	108	123	140	156	175	192	209	227	243	260	277	293
2,00	112	130	148	167	186	204	222	239	258	277	294	314
2,20	116	136	155	175	194	215	235	254	274	293	314	332
2,40	121	141	162	185	206	227	248	268	290	312	331	353
2,60	127	148	171	193	215	238	260	283	306	328	351	371
2,80	130	154	177	201	227	250	274	296	321	345	368	392
3,00	136	160	186	212	236	262	286	312	337	362	388	412

Características de los tejidos

Tejido	Ancho de rollo (ml)	Sin termosoldadura		Con termosoldadura
		Alto x Ancho	Alto x Ancho	Alto x Ancho
031064 Mimo R	2,70	3,00x2,70	-	-
031128 Fobos	2,50	3,00x2,40	-	-
131136 Tiore	2,50	3,00x2,40	-	-
031028 Shantung-M1	2,00	3,00x2,00	-	-
031285 Leda Black-Out	2,00	3,00x2,00	-	-
031286 Herse Black-Out	2,80	3,00x2,80	-	-
031289 Arce	2,60	3,00x2,60	-	-

Medidas en m.

- A efectos de precio se redondeará a la inmediata superior.
- Los sistemas eje 44 y 65 están cotizados con accionamiento a cadena.
- Los sistemas eje de 65 llevan desmultiplicador.
- El sistema eje 65 y 80 no incluye accionamiento, deberá incrementar en el precio el accionamiento deseado (cardán o motor).

● Límite de cambio de mecanismo simple a desmultiplicador.



Estor enrollable

Filtro solar

Precio € ud										
Sistema a cadena										
Eje de 44										
Alto	0,60	0,80	1,00	1,20	1,40	1,60	1,80	2,00	2,20	2,40
1,00	127	154	181	209	236	263	290	316	344	370
1,20	140	173	205	236	267	299	330	363	393	426
1,40	154	191	228	263	299	336	370	407	444	481
1,60	169	210	251	291	331	371	413	453	495	535
1,80	182	228	274	317	363	408	453	-	-	-
2,00	198	247	296	345	394	445	495	-	-	-
2,20	212	266	320	374	428	482	535	-	-	-
2,40	225	285	343	401	459	518	577	-	-	-
2,60	239	302	366	428	491	554	618	-	-	-
2,80	253	321	389	457	523	591	658	-	-	-
3,00	268	340	412	483	555	627	698	-	-	-

Características de los tejidos

Tejido	Ancho de rollo (m)	Sin termosoldadura		Con termosoldadura
		Alto x Ancho	Alto x Ancho	Alto x Ancho
031014 Filtro solar	1,80	3,00x1,80	1,60x2,40	-

Bamboo • Ariel • Jano • Azur • Letho • Cosmos • Atlas • Altea • Casablanca • Tebe

Precio € ud												
Sistema a cadena											Sistema	
Eje de 44											Eje de 60 y 65	
Alto	0,60	0,80	1,00	1,20	1,40	1,60	1,80	2,00	2,20	2,40	2,60	2,80
1,00	95	109	123	138	152	167	179	194	210	224	238	252
1,20	100	116	133	150	166	181	198	214	230	247	263	278
1,40	108	127	143	161	179	198	216	235	252	270	289	307
1,60	114	135	154	174	193	214	235	254	274	293	314	334
1,80	121	141	163	186	209	230	252	274	294	317	340	362
2,00	127	151	175	198	222	245	269	293	316	342	365	389
2,20	133	159	185	210	236	262	288	313	339	365	390	415
2,40	139	167	194	222	251	277	305	332	361	389	415	443
2,60	147	175	205	235	265	293	323	352	382	412	442	469
2,80	152	185	215	247	277	308	342	371	404	434	466	498
3,00	159	192	225	258	292	325	359	391	426	459	491	526

Características de los tejidos

Tejido	Ancho de rollo (m)	Sin termosoldadura		Con termosoldadura
		Alto x Ancho	Alto x Ancho	Alto x Ancho
031021 Bamboo	2,30	3,00x2,00	-	-
031111 Ariel	2,80	3,00x2,80	-	-
031113 Jano	2,80	3,00x2,80	-	-
031120 Azur	2,50	3,00x2,40	2,20x2,80	-
031130 Letho	2,50	3,00x2,40	-	-
031138 Cosmos	2,70	3,00x2,60	2,40x2,80	-
031142 Atlas	2,80	3,00x2,80	-	-
031104 Altea	2,40	3,00x2,40	-	-
031105 Casablanca	2,80	3,00x2,80	-	-
031288 Tebe	2,80	3,00x2,80	2,40x2,80	-

Medidas en m.

- A efectos de precio se redondeará a la inmediata superior.
- Los sistemas eje 44 y 65 están cotizados con accionamiento a cadena.
- Los sistemas eje de 65 llevan desmultiplicador.
- El sistema eje 65 y 80 no incluye accionamiento, deberá incrementar en el precio el accionamiento deseado (cardán o motor).

Límite de cambio de mecanismo simple a desmultiplicador.



Estor enrollable

Jávea • Brasilia • Screen Nimbus • Screen Kore • Cosmo Perla • Hidra • Hiperion Black-Out • Umbriel

Precio € ud

Alto	Sistema a cadena Eje de 44										Sistema Eje de 60 y 65	
	0,60	0,80	1,00	1,20	1,40	1,60	1,80	2,00	2,20	2,40	2,60	2,80
1,00	118	140	163	187	209	231	253	276	299	321	344	366
1,20	130	155	181	209	235	260	286	312	339	365	390	415
1,40	140	171	200	230	260	289	317	348	378	407	437	466
1,60	153	186	219	252	285	317	351	384	417	450	483	516
1,80	163	200	237	274	311	346	383	420	457	492	529	566
2,00	175	215	255	294	336	375	415	457	496	536	576	616
2,20	187	230	274	316	362	405	447	491	535	580	622	666
2,40	198	245	292	340	386	432	481	528	576	621	669	716
2,60	209	260	311	362	412	462	514	564	615	665	715	767
2,80	220	275	329	383	438	491	545	599	654	708	761	817
3,00	231	290	346	405	463	520	578	635	693	751	808	867

Características de los tejidos

Tejido	Ancho de rollo (ml)	Sin termosoldadura	Con termosoldadura
		Alto x Ancho	Alto x Ancho
031101 Jávea	3,00	3,00x2,80	-
031102 Brasilia	2,80	3,00x2,80	-
031134 Screen Nimbus	2,50	4,00x2,40	2,20x2,80
031137 Screen Kore	2,50	3,00x2,40	-
031139 Cosmos Perla	2,35	3,00x2,30	2,10x2,80
031140 Hidra	3,00	3,00x2,80	-
031143 Hiperion Black-Out	3,00	3,00x2,80	-
031287 Umbriel	3,00	3,00x2,80	-

Hispa • Anae • Stella

Precio € ud

Alto	Sistema a cadena Eje de 44										Sistema Eje de 60 y 65	
	0,60	0,80	1,00	1,20	1,40	1,60	1,80	2,00	2,20	2,40	2,60	2,80
1,00	112	131	153	175	194	216	237	258	279	300	321	342
1,20	122	146	169	194	219	243	267	291	316	340	365	389
1,40	131	160	187	215	243	269	298	325	353	381	407	435
1,60	143	174	205	236	266	298	328	359	390	420	452	482
1,80	153	187	222	255	290	324	358	392	427	460	495	529
2,00	163	201	239	276	314	351	389	427	463	501	538	576
2,20	175	215	255	296	338	378	419	459	500	542	582	622
2,40	185	229	274	317	361	405	450	493	538	581	624	669
2,60	194	243	290	338	384	431	480	527	574	621	668	716
2,80	206	256	307	358	408	459	509	560	611	661	712	762
3,00	216	270	324	378	432	485	541	593	647	703	756	810

Características de tejidos

Tejido	Ancho de rollo (ml)	Sin termosoldadura	Con termosoldadura
		Alto x Ancho	Alto x Ancho
031112 Hispa	3,00	3,00x2,20	-
031115 Anae	2,20	3,00x2,20	-
031116 Stella	2,50	4,00x2,40	2,20x2,80

Medidas en m.

- A efectos de precio se redondeará a la inmediata superior.
- Los sistemas eje 44 y 65 están cotizados con accionamiento a cadena.
- Los sistemas eje de 65 llevan desmultiplicador.
- El sistema eje 65 y 80 no incluye accionamiento, deberá incrementar en el precio el accionamiento deseado (cardán o motor).

Límite de cambio de mecanismo simple a desmultiplicador.



Berlín Black-Out

Precio € ud																
Alto	Sistema a cadena Eje de 44									Sistema Ejes de 60 y 65			Sistema Eje de 80			
	0,60	0,80	1,00	1,20	1,40	1,60	1,80	2,00	2,20	2,40	2,60	2,80	3,00	3,20	3,40	3,60
1,00	92	109	124	141	159	175	192	209	227	243	299	316	336	354	374	427
1,20	99	117	137	155	175	193	214	232	252	270	329	351	371	392	414	468
1,40	105	128	150	171	192	213	235	255	277	299	361	383	407	430	453	511
1,60	113	137	161	185	209	231	255	279	304	328	391	417	443	468	495	554
1,80	121	147	173	199	225	251	277	304	330	355	422	450	478	506	535	597
2,00	128	155	185	213	240	269	299	328	355	384	452	483	515	544	576	639
2,20	135	166	197	228	258	289	320	351	382	413	483	516	549	582	615	682
2,40	140	175	209	240	275	307	342	375	407	442	-	-	-	-	-	-
2,60	150	185	219	255	291	327	363	399	434	469	-	-	-	-	-	-
2,80	155	193	231	269	307	345	384	422	460	498	-	-	-	-	-	-
3,00	162	204	244	285	325	365	405	445	485	527	-	-	-	-	-	-
3,20	169	213	255	298	342	383	427	469	511	555	-	-	-	-	-	-
3,40	177	222	267	313	357	403	447	492	539	583	-	-	-	-	-	-
3,60	185	231	278	327	374	421	469	518	565	612	-	-	-	-	-	-
3,80	191	240	291	342	391	440	490	541	591	641	-	-	-	-	-	-
4,00	198	251	304	354	407	459	511	565	616	669	-	-	-	-	-	-

Características de los tejidos

Tejido	Ancho de rollo (ml)	Sin termosoldadura		Con termosoldadura
031069 ● Berlín Black-Out	2,40	 Alto x Ancho	 Alto x Ancho	 Alto x Ancho
		4,00x2,40	2,20x3,60	-

Darktex Black-Out

Precio € ud																
Alto	Sistema a cadena Eje de 44									Sistema Ejes de 60 y 65			Sistema Eje de 80			
	0,60	0,80	1,00	1,20	1,40	1,60	1,80	2,00	2,20	2,40	2,60	2,80	3,00	3,20	3,40	3,60
1,00	112	131	151	171	190	210	230	250	269	289	331	353	375	397	444	467
1,20	121	141	166	189	212	235	255	278	302	325	370	394	420	444	496	521
1,40	129	154	179	206	231	256	283	308	334	361	408	4463	465	491	545	574
1,60	138	167	194	224	253	282	311	339	367	282	447	478	508	541	597	628
1,80	147	178	210	243	274	305	337	368	401	431	485	520	554	587	646	681
2,00	155	191	225	260	293	329	365	399	432	467	526	561	598	635	697	735
2,20	166	201	239	277	315	353	390	428	466	504	565	604	643	682	749	789
2,40	174	214	254	294	336	376	417	458	498	539	603	645	688	730	798	843
2,60	182	227	269	313	357	401	444	488	530	576	642	685	733	779	850	896
2,80	191	238	285	331	378	424	470	518	565	611	680	729	777	-	-	-
3,00	200	251	299	350	399	447	498	546	597	645	719	771	822	-	-	-
3,20	210	262	314	367	420	472	523	577	630	682	758	812	867	-	-	-
3,40	217	274	329	384	440	496	551	606	661	718	796	854	913	-	-	-
3,60	228	286	344	403	462	520	578	636	695	754	835	895	1012	-	-	-
3,80	236	298	359	421	482	543	605	666	729	789	873	936	999	-	-	-
4,00	245	311	374	439	503	567	633	696	760	825	912	979	1047	-	-	-

Características de los tejidos

Tejido	Ancho de rollo (ml)	Sin termosoldadura		Con termosoldadura
030338 ● Darktex Black-Out	3,00	 Alto x Ancho	 Alto x Ancho	 Alto x Ancho
		4,00x3,00	2,60x3,60	-

Medidas en m.

- A efectos de precio se redondeará a la inmediata superior.
- Los sistemas eje 44 y 65 están cotizados con accionamiento a cadena.
- Los sistemas eje de 65 llevan desmultiplicador.
- El sistema eje 65 y 80 no incluye accionamiento, deberá incrementar en el precio el accionamiento deseado (cardán o motor).

● Límite de cambio de mecanismo simple a desmultiplicador.



Estor enrollable

Sax Screen 3600 1% 5% 10%

Alto	Precio € ud																						
	Sistema a cadena Eje de 44										Sistema Eje de 60 y 65				Sistema Eje de 80								
	0,60	0,80	1,00	1,20	1,40	1,60	1,80	2,00	2,20	2,40	2,60	2,80	3,00	3,20	3,40	3,60	3,80	4,00	4,20	4,40	4,60	4,80	5,00
1,00	92	109	127	141	159	176	192	210	227	243	292	312	330	350	393	413	432	452	472	491	511	530	551
1,20	99	117	137	156	176	194	214	232	252	273	324	345	366	388	434	457	478	501	522	544	566	587	611
1,40	105	128	150	171	192	214	236	256	278	301	354	378	403	426	476	500	523	547	573	597	621	645	659
1,60	114	137	161	186	209	232	256	279	305	329	386	412	438	463	516	542	568	596	622	649	675	703	730
1,80	121	147	174	199	227	252	278	305	330	357	417	445	475	501	557	584	615	643	673	700	731	759	789
2,00	128	155	186	214	243	270	299	329	357	386	447	478	508	541	597	628	659	691	722	754	785	817	849
2,20	136	166	197	228	258	290	321	352	383	414	480	511	544	578	637	672	705	738	773	807	840	874	909
2,40	141	176	209	243	276	308	343	376	409	443	508	545	581	616	677	713	750	787	821	858	895	932	968
2,60	150	186	220	256	292	328	365	400	437	470	541	578	616	654	718	757	795	834	872	911	949	988	1.027
2,80	155	194	232	270	308	348	386	424	462	501	572	612	653	692	758	799	840	882	922	964	1.004	1.045	1.087
3,00	163	205	245	286	327	367	407	447	489	529	603	645	688	730	798	843	886	928	972	1.015	1.059	1.102	1.147
3,20	171	214	255	299	343	386	428	470	515	558	634	679	722	769	838	886	932	978	1.022	1.067	1.114	1.160	1.205
3,40	177	224	268	314	359	405	450	496	541	585	665	712	759	807	881	928	975	1.025	1.072	1.121	1.167	1.217	1.265
3,60	185	232	279	328	376	424	470	519	567	615	696	745	795	845	921	971	1.022	1.072	1.122	1.174	1.224	1.274	1.326
3,80	192	243	292	343	392	443	492	543	593	643	728	779	831	883	961	1.013	1.066	1.120	1.173	1.225	1.278	1.331	1.386
4,00	199	252	305	355	408	462	515	567	619	672	758	812	867	921	1.002	1.058	1.111	1.166	1.222	1.278	1.333	1.389	1.444

Sax Screen 5500 1% 3% 5% 10% • Sax Screen Dione

Alto	Precio € ud																						
	Sistema a cadena Eje de 44										Sistema Eje de 60 y 65				Sistema Eje de 80								
	0,60	0,80	1,00	1,20	1,40	1,60	1,80	2,00	2,20	2,40	2,60	2,80	3,00	3,20	3,40	3,60	3,80	4,00	4,20	4,40	4,60	4,80	5,00
1,00	108	127	143	162	179	199	217	236	254	273	314	334	354	375	421	443	465	484	506	528	547	569	592
1,20	115	137	156	178	199	220	243	263	285	305	350	371	394	419	467	491	516	539	564	587	611	635	659
1,40	123	148	171	194	217	243	267	290	314	337	384	409	437	462	514	541	567	593	620	646	673	699	728
1,60	131	159	185	212	237	265	291	316	344	369	420	447	477	505	559	589	619	646	677	707	735	766	795
1,80	139	169	198	228	255	286	315	344	374	403	455	485	518	547	605	637	670	700	734	767	797	830	863
2,00	148	179	212	244	275	307	340	370	404	434	490	523	558	592	652	685	721	756	791	826	859	895	930
2,20	155	191	225	260	293	329	365	399	432	467	526	561	598	635	697	735	773	810	848	886	922	960	998
2,40	163	201	238	276	313	351	389	426	463	500	560	599	639	679	743	784	824	864	905	945	984	1.025	1.065
2,60	173	213	252	292	331	371	413	452	492	532	596	637	680	721	789	833	876	918	961	1.004	1.047	1.089	1.134
2,80	179	224	266	308	351	393	438	480	522	565	631	675	720	766	835	882	927	972	1.019	1.064	1.109	1.155	1.201
3,00	189	235	278	325	369	415	462	506	553	597	666	713	760	808	882	930	979	1.026	1.075	1.124	1.172	1.219	1.268
3,20	197	245	292	342	389	438	485	534	582	630	700	751	800	851	927	979	1.029	1.080	1.133	1.183	1.234	1.285	1.336
3,40	205	255	306	357	407	459	509	560	612	661	736	789	843	895	973	1.027	1.082	1.135	1.188	1.242	1.295	1.350	1.404
3,60	213	267	320	374	427	481	535	587	642	695	772	827	883	938	1.020	1.076	1.137	1.188	1.244	1.302	1.357	1.415	1.471
3,80	220	277	332	390	445	503	559	615	672	728	807	865	923	982	1.065	1.125	1.185	1.242	1.302	1.362	1.419	1.480	1.540
4,00	229	289	346	406	465	523	583	642	700	759	843	903	964	1.025	1.111	1.174	1.236	1.297	1.358	1.421	1.482	1.544	1.607

Características de los tejidos

Tejido	Ancho de rollo (ml)	Sin termosoldadura		Con termosoldadura	
		Alto x Ancho	Alto x Ancho	Alto x Ancho	Alto x Ancho
030680 ● Sax Screen 3600 1%	3,00	4,00x3,00	2,70x5,00	4,00x5,00	4,00x5,00
030680 ● Sax Screen 3600 5%	3,00	4,00x3,00	2,70x5,00	4,00x5,00	4,00x5,00
030680 ● Sax Screen 3600 10%	2,50	4,00x2,50	2,20x5,00	4,00x5,00	4,00x5,00
031006 ● Sax Screen 5500 1%	2,50	4,00x2,50	2,20x5,00	4,00x5,00	4,00x5,00
031006 ● Sax Screen 5500 3%	3,00	4,00x3,00	2,70x5,00	4,00x5,00	4,00x5,00
031006 ● Sax Screen 5500 5%	3,00	4,00x3,00	2,70x5,00	4,00x5,00	4,00x5,00
031006 ● Sax Screen 5500 10%	2,50	4,00x2,50	2,20x5,00	4,00x5,00	4,00x5,00
031291 ● Sax Screen Dione 3%	3,00	4,00x3,00	2,70x5,00	4,00x5,00	4,00x5,00

Medidas en m.

- A efectos de precio se redondeará a la inmediata superior.
- Los sistemas eje 44 y 65 están cotizados con accionamiento a cadena.
- Los sistemas eje de 65 llevan desmultiplicador.
- El sistema eje 65 y 80 no incluye accionamiento, deberá incrementar en el precio el accionamiento deseado (cardán o motor).

Límite de cambio de mecanismo simple a desmultiplicador.



Black-Out

		Precio € ud																						
		Sistema a cadena Eje de 44									Sistema Eje de 60 y 65				Sistema Eje de 80									
Alto		0,60	0,80	1,00	1,20	1,40	1,60	1,80	2,00	2,20	2,40	2,60	2,80	3,00	3,20	3,40	3,60	3,80	4,00	4,20	4,40	4,60	4,80	5,00
1,00		92	109	124	141	159	175	192	209	227	243	299	316	336	354	374	427	445	465	484	504	522	543	561
1,20		99	117	137	155	175	193	214	232	252	270	329	351	371	392	414	468	490	511	534	557	578	599	621
1,40		105	128	150	171	192	213	235	255	277	299	361	383	407	430	453	511	535	559	583	607	633	657	681
1,60		113	137	161	185	209	231	255	279	304	328	391	417	443	468	495	554	581	606	634	660	685	713	741
1,80		121	147	173	199	225	251	277	304	330	355	422	450	478	506	535	597	624	654	683	712	741	771	798
2,00		128	155	185	213	240	269	299	328	355	384	452	483	515	544	576	639	670	700	733	766	796	827	858
2,20		135	166	197	228	258	289	320	351	382	413	483	516	549	582	615	682	715	749	782	817	850	884	918
2,40		140	175	209	240	275	307	342	375	407	442	515	549	584	620	656	723	760	796	833	869	905	941	978
2,60		150	185	219	255	291	327	363	399	434	469	545	582	620	658	696	768	806	844	883	921	959	998	1.036
2,80		155	193	231	269	307	345	384	422	460	498	576	616	657	696	736	810	850	890	932	973	1.013	1.055	1.096
3,00		162	204	244	285	325	365	405	445	485	527	606	649	692	734	775	852	895	938	982	1.025	1.067	1.111	1.155
3,20		169	213	255	298	342	383	427	469	511	555	637	682	728	772	817	895	941	986	1.032	1.078	1.122	1.167	1.214
3,40		177	222	267	313	357	403	447	492	539	583	669	715	761	810	857	938	986	1.033	1.082	1.128	1.176	1.225	1.273
3,60		185	231	278	327	374	421	469	518	565	612	698	749	798	848	897	981	1.029	1.080	1.129	1.181	1.232	1.281	1.332
3,80		191	240	291	342	391	440	490	541	591	641	730	781	834	886	936	1.024	1.075	1.127	1.180	1.234	1.287	1.339	1.392
4,00		198	251	304	354	407	459	511	565	616	669	760	814	869	923	978	1.065	1.121	1.175	1.231	1.287	1.340	1.395	1.451

• Black-Out Ancho de rollo de 3,00 para las referencias: 1000, 1001, 1002, 1003, 1007.

Características de los tejidos

Tejido	Ancho de rollo (ml)	Sin termosoldadura		Con termosoldadura
		Alto x Ancho	Alto x Ancho	Alto x Ancho
031001 ● Black-Out	1,80	4,00x1,80	1,50x5,00	4,00x5,00
031001 ● Black-Out	3,00	4,00x3,00	2,70x3,00	4,00x5,00

Screen Artemis 1% 3% 5%

		Precio € ud																					
		Sistema a cadena Eje de 44									Sistema Eje de 60 y 65												
Alto		0,60	0,80	1,00	1,20	1,40	1,60	1,80	2,00	2,20	2,40	2,60	2,80	3,00	2,60	2,80	3,00	2,60	2,80	3,00			
1,00		108	127	143	162	179	199	217	236	254	273	314	334	354	314	334	354	314	334	354	314	334	354
1,20		115	137	156	178	199	220	243	263	285	305	350	371	394	350	371	394	350	371	394	350	371	394
1,40		123	148	171	194	217	243	267	290	314	337	384	409	437	384	409	437	384	409	437	384	409	437
1,60		131	159	185	212	237	265	291	316	344	369	420	447	477	420	447	477	420	447	477	420	447	477
1,80		139	169	198	228	255	286	315	344	374	403	455	485	518	455	485	518	455	485	518	455	485	518
2,00		148	179	212	244	275	307	340	370	404	434	490	523	558	490	523	558	490	523	558	490	523	558
2,20		155	191	225	260	293	329	365	399	432	467	526	561	598	526	561	598	526	561	598	526	561	598
2,40		163	201	238	276	313	351	389	426	463	500	560	599	639	560	599	639	560	599	639	560	599	639
2,60		173	213	252	292	331	371	413	452	492	532	596	637	680	596	637	680	596	637	680	596	637	680
2,80		179	224	266	308	351	393	438	480	522	565	631	675	720	631	675	720	631	675	720	631	675	720
3,00		189	235	278	325	369	415	462	506	553	597	666	713	760	666	713	760	666	713	760	666	713	760
3,20		197	245	292	342	389	438	485	534	582	630	700	751	800	700	751	800	700	751	800	700	751	800
3,40		205	255	306	357	407	459	509	560	612	661	736	789	843	736	789	843	736	789	843	736	789	843
3,60		213	267	320	374	427	481	535	587	642	695	772	827	883	772	827	883	772	827	883	772	827	883
3,80		220	277	332	390	445	503	559	615	672	728	807	865	923	807	865	923	807	865	923	807	865	923
4,00		229	289	346	406	465	523	583	642	700	759	843	903	964	843	903	964	843	903	964	843	903	964

Características de los tejidos

Tejido	Ancho de rollo (ml)	Sin termosoldadura
		Alto x Ancho
031144 ● Screen Artemis 1%	3,10	4,00x3,00
031144 ● Screen Artemis 3%	3,10	4,00x3,00
031144 ● Screen Artemis 5%	3,10	4,00x3,00

Características de los tejidos

Tejido	Ancho de rollo (ml)	Sin termosoldadura
		Alto x Ancho
031144 ● Screen Artemis 1%	2,50	4,00x2,50
031144 ● Screen Artemis 3%	2,50	4,00x2,50
031144 ● Screen Artemis 5%	2,50	4,00x2,50

• A efectos de precio se redondeará a la inmediata superior.

• Los sistemas eje 44 y 65 están cotizados con accionamiento a cadena.

• Los sistemas eje de 65 llevan desmultiplicador.

• El sistema eje 65 y 80 no incluye accionamiento, deberá incrementar en el precio el accionamiento deseado (cardán o motor).

Medidas en m.

Límite de cambio de mecanismo simple a desmultiplicador.



Estor enrollable

Screen 8505 • Screen 2165 • Soltis Harmony 88 • Soltis Lounge 96 • Soltis 99 • Screen Titan

Precio € ud

Alto	Sistema a cadena Eje de 44										Sistema Eje de 60 y 65				Sistema Eje de 80									
	0,60	0,80	1,00	1,20	1,40	1,60	1,80	2,00	2,20	2,40	2,60	2,80	3,00	3,20	3,40	3,60	3,80	4,00	4,20	4,40	4,60	4,80	5,00	
1,00	118	143	168	191	215	238	263	288	311	334	391	417	443	468	495	527	554	580	606	634	659	685	713	
1,20	131	159	187	214	240	269	296	325	352	380	440	469	500	529	559	595	624	656	685	716	748	776	808	
1,40	141	174	206	237	268	299	330	363	393	426	490	522	557	591	622	662	697	731	767	799	834	868	903	
1,60	154	190	225	260	294	330	366	401	437	470	539	577	614	650	688	731	769	807	845	883	921	959	998	
1,80	166	205	244	282	321	361	400	439	477	516	589	630	670	711	753	799	840	883	925	966	1.009	1.050	1.091	
2,00	176	219	263	305	348	390	432	477	519	561	637	682	728	772	817	868	913	844	1.119	1.050	1.096	1.141	1.187	
2,20	189	235	282	328	374	421	467	515	560	606	685	735	784	833	882	935	986	1.034	1.084	1.134	1.183	1.232	1.281	
2,40	199	250	301	351	401	451	501	553	603	653	736	788	840	894	945	1.004	1.058	1.110	1.164	1.217	1.270	1.323	1.377	
2,60	212	266	320	374	428	482	536	591	644	698	785	843	897	952	1.010	1.072	1.128	1.186	1.242	1.300	1.356	1.413	1.471	
2,80	222	279	339	394	453	511	569	628	684	743	835	895	953	1.013	1.074	1.141	1.201	1.262	1.323	1.383	1.444	1.505	1.566	
3,00	232	294	357	419	481	542	604	666	728	789	884	948	1.011	1.075	1.139	1.210	1.274	1.337	1.403	1.467	1.531	1.596	1.661	
3,20	245	311	376	442	506	573	637	704	769	834	933	1.001	1.067	1.136	1.203	1.277	1.346	1.413	1.482	1.550	1.619	1.686	1.756	
3,40	255	325	394	465	534	603	672	742	811	881	983	1.052	1.125	1.197	1.267	1.346	1.417	1.489	1.563	1.633	1.705	1.778	1.850	
3,60	268	342	414	488	560	634	707	780	852	926	1.032	1.107	1.181	1.256	1.332	1.413	1.489	1.565	1.641	1.717	1.793	1.869	1.946	
3,80	278	355	432	508	585	662	741	818	894	971	1.082	1.160	1.239	1.317	1.396	1.482	1.561	1.641	1.720	1.800	1.880	1.960	2.039	
4,00	290	370	452	532	614	693	774	856	935	1.017	1.129	1.213	1.295	1.378	1.462	1.550	1.633	1.717	1.800	1.884	1.968	2.050	2.134	

• Soltis Harmony 88 Ancho de rollo de 2,67 para las referencias: 2044, 2171, 2048, 2167, 2047, 2053, 2175, 2135, 50265, 2012, 50329, 2043.

• Soltis 99 Ancho de rollo de 2,67 para las referencias: 2058, 2059, 2044, 50301, 2055, 50285, 50286, 2068, 50303.

Soltis Horizon 86

Precio € ud

Alto	Sistema a cadena Eje de 44										Sistema Eje de 60 y 65				Sistema Eje de 80									
	0,60	0,80	1,00	1,20	1,40	1,60	1,80	2,00	2,20	2,40	2,60	2,80	3,00	3,20	3,40	3,60	3,80	4,00	4,20	4,40	4,60	4,80	5,00	
1,00	128	153	177	204	228	253	278	304	329	353	403	429	457	483	536	565	593	620	649	677	704	733	760	
1,20	139	169	198	228	255	286	315	344	374	403	455	485	518	547	605	637	670	700	734	767	797	830	863	
1,40	152	186	217	252	285	317	352	384	419	451	507	543	578	614	674	711	748	782	819	856	890	927	964	
1,60	163	201	238	276	313	351	389	426	463	500	560	599	639	679	743	784	825	864	905	945	984	1.025	1.065	
1,80	176	217	258	301	342	383	426	466	507	547	614	657	699	743	812	857	902	945	989	1.034	1.078	1.122	1.166	
2,00	189	235	278	325	369	415	462	506	553	597	666	713	760	808	882	930	979	1.026	1.075	1.124	1.172	1.219	1.268	
2,20	200	251	299	350	399	447	498	546	597	645	719	771	821	873	950	1.003	1.057	1.107	1.160	1.213	1.264	1.317	1.370	
2,40	213	267	320	374	427	481	535	587	642	695	772	827	883	938	1.020	1.076	1.134	1.188	1.244	1.302	1.357	1.415	1.471	
2,60	225	283	340	399	455	514	572	628	685	743	825	884	944	1.003	1.088	1.149	1.211	1.270	1.331	1.392	1.451	1.512	1.572	
2,80	237	299	361	422	483	545	607	669	731	792	876	941	1.004	1.067	1.158	1.222	1.288	1.351	1.416	1.481	1.544	1.609	1.674	
3,00	250	315	381	446	511	578	644	710	775	840	930	998	1.065	1.134	1.226	1.295	1.365	1.432	1.502	1.570	1.639	1.707	1.776	
3,20	262	331	401	470	541	611	681	750	820	889	983	1.055	1.126	1.198	1.295	1.369	1.442	1.513	1.586	1.659	1.732	1.804	1.877	
3,40	274	348	421	496	568	643	718	791	865	938	1.036	1.111	1.187	1.263	1.365	1.442	1.519	1.594	1.671	1.748	1.824	1.901	1.978	
3,60	286	365	442	520	597	675	754	831	910	987	1.088	1.167	1.249	1.328	1.433	1.515	1.596	1.677	1.757	1.838	1.918	1.999	2.082	
3,80	298	381	462	544	624	708	791	872	953	1.036	1.141	1.225	1.310	1.393	1.503	1.588	1.673	1.757	1.842	1.927	2.011	2.096	2.183	
4,00	311	397	482	568	654	741	827	912	999	1.084	1.194	1.281	1.370	1.457	1.571	1.661	1.750	1.838	1.927	2.016	2.105	2.193	2.284	

• Soltis Horizon 86 Ancho de rollo de 2,67 para las referencias: 2044, 2046, 2053, 2167, 2045, 2175, 2135, 2012, 2043, 2051, 2171, 2047.

Características de los tejidos

Tejido	Ancho de rollo (ml)	Sin termosoldadura		Con termosoldadura
		Alto x Ancho	Alto x Ancho	Alto x Ancho
031007 ● Screen 8505	2,50	4,00x2,50	2,20x5,00	4,00x5,00
031010 ● Screen 2165	2,50	4,00x2,50	2,20x5,00	4,00x5,00
030977 ● Soltis Harmony 88	1,77	4,00x1,77	1,45x5,00	4,00x5,00
030977 ● Soltis Harmony 88	2,67	4,00x2,67	1,45x5,00	4,00x5,00
031063 ● Soltis Lounge 96	2,67	4,00x2,67	2,35x5,00	4,00x5,00
030698 Soltis 99	1,77	4,00x1,77	1,45x5,00	4,00x5,00
030698 Soltis 99	2,67	4,00x2,67	2,35x5,00	4,00x5,00
030970 ● Screen Titan	3,20	4,00x3,20	2,90x5,00	4,00x5,00
031082 ● Soltis Horizon 86	1,77	4,00x1,77	1,45x5,00	4,00x5,00
031082 ● Soltis Horizon 86	2,67	4,00x2,67	2,35x5,00	4,00x5,00

Medidas en m.

- A efectos de precio se redondeará a la inmediata superior.
- Los sistemas eje 44 y 65 están cotizados con accionamiento a cadena.
- Los sistemas eje de 65 llevan desmultiplicador.
- El sistema eje 65 y 80 no incluye accionamiento, deberá incrementar en el precio el accionamiento deseado (cardán o motor).

● ● Límite de cambio de mecanismo simple a desmultiplicador.



Soltis Perform 92 • Soltis Proof W96

		Precio € ud																						
		Sistema a cadena Eje de 44								Sistema Eje de 60 y 65				Sistema Eje de 80										
Alto		0,60	0,80	1,00	1,20	1,40	1,60	1,80	2,00	2,20	2,40	2,60	2,80	3,00	3,20	3,40	3,60	3,80	4,00	4,20	4,40	4,60	4,80	5,00
1,00		140	175	209	240	275	307	342	375	407	442	515	549	584	620	656	718	754	789	826	863	897	934	971
1,20		159	198	237	275	314	353	392	431	469	508	589	630	670	711	753	820	861	903	945	987	1.028	1.071	1.113
1,40		176	220	266	311	354	400	444	489	534	578	661	710	756	800	849	922	969	1.017	1.064	1.111	1.159	1.205	1.255
1,60		192	243	293	344	393	444	495	545	596	645	736	788	840	894	945	1.025	1.078	1.129	1.185	1.237	1.290	1.342	1.396
1,80		210	266	323	378	432	490	545	603	658	713	810	868	926	984	1.042	1.126	1.186	1.243	1.303	1.362	1.421	1.480	1.540
2,00		227	289	351	412	475	535	597	659	720	782	884	948	1.011	1.075	1.139	1.229	1.294	1.357	1.424	1.488	1.551	1.617	1.681
2,20		244	312	380	445	514	581	649	716	782	850	959	1.027	1.097	1.165	1.236	1.332	1.401	1.471	1.542	1.611	1.682	1.754	1.823
2,40		262	334	407	481	554	627	699	773	846	920	1.032	1.107	1.181	1.256	1.332	1.433	1.509	1.585	1.661	1.737	1.812	1.888	1.965
2,60		277	355	437	515	593	672	750	830	909	987	1.105	1.186	1.267	1.349	1.428	1.535	1.618	1.699	1.781	1.862	1.945	2.025	2.108
2,80		294	380	465	547	633	718	800	887	971	1.055	1.179	1.265	1.352	1.439	1.526	1.639	1.725	1.812	1.900	1.987	2.075	2.162	2.249
3,00		312	403	492	582	673	761	852	944	1.033	1.124	1.254	1.346	1.438	1.530	1.622	1.741	1.834	1.926	2.019	2.113	2.205	2.299	2.392
3,20		329	426	521	616	712	808	905	1.001	1.096	1.191	1.328	1.426	1.523	1.620	1.719	1.843	1.940	2.039	2.139	2.238	2.337	2.436	2.533
3,40		346	447	549	652	753	854	956	1.058	1.159	1.260	1.401	1.505	1.608	1.710	1.816	1.946	2.049	2.153	2.259	2.362	2.467	2.570	2.676
3,60		363	469	578	684	792	898	1.006	1.114	1.221	1.328	1.475	1.584	1.694	1.803	1.911	2.048	2.159	2.267	2.378	2.489	2.597	2.707	2.819
3,80		381	492	606	719	831	945	1.058	1.172	1.282	1.395	1.548	1.664	1.779	1.894	2.009	2.149	2.266	2.381	2.497	2.613	2.729	2.844	2.960
4,00		397	516	635	753	872	989	1.109	1.227	1.346	1.465	1.623	1.743	1.863	1.985	2.105	2.252	2.375	2.494	2.616	2.739	2.859	2.981	3.102

• Soltis Perform 92 Ancho de rollo de 2,67 para las referencias: 2044, 2167, 2047, 2053, 2045, 20265, 2135, 2175, 2043, 20272, 2171, 2046, 2048, 2051, 2074, 2012.

Soltis Opaque B92 • Screen Elarus Black-Out

		Precio € ud																						
		Sistema a cadena Eje de 44								Sistema Eje de 60 y 65				Sistema Eje de 80										
Alto		0,60	0,80	1,00	1,20	1,40	1,60	1,80	2,00	2,20	2,40	2,60	2,80	3,00	3,20	3,40	3,60	3,80	4,00	4,20	4,40	4,60	4,80	5,00
1,00		168	207	245	285	323	362	401	439	478	516	578	619	659	699	767	808	850	890	933	974	1.015	1.058	1.099
1,20		189	235	278	325	369	415	462	506	553	597	666	713	760	808	882	930	979	1.026	1.075	1.124	1.172	1.219	1.268
1,40		209	262	313	366	417	469	522	574	627	679	754	808	863	915	997	1.051	1.107	1.162	1.217	1.273	1.327	1.381	1.438
1,60		229	289	346	406	465	523	583	642	700	759	843	903	964	1.025	1.111	1.174	1.236	1.297	1.358	1.421	1.482	1.544	1.607
1,80		250	315	381	446	511	578	644	710	775	840	930	998	1.065	1.134	1.226	1.295	1.365	1.432	1.502	1.570	1.639	1.707	1.776
2,00		269	343	414	488	559	633	705	776	850	922	1.019	1.091	1.166	1.241	1.341	1.417	1.493	1.567	1.643	1.719	1.794	1.870	1.946
2,20		290	369	447	528	606	685	767	845	925	1.003	1.105	1.187	1.268	1.350	1.456	1.540	1.622	1.703	1.785	1.869	1.949	2.032	2.114
2,40		311	397	482	568	654	741	827	912	999	1.084	1.194	1.281	1.370	1.457	1.571	1.661	1.750	1.838	1.927	2.016	2.105	2.193	2.284
2,60		330	424	516	610	700	795	888	981	1.074	1.165	1.281	1.377	1.471	1.566	1.686	1.783	1.879	1.973	2.070	2.165	2.261	2.356	2.453
2,80		351	451	549	650	749	849	949	1.048	1.148	1.247	1.370	1.471	1.572	1.674	1.801	1.904	2.008	2.109	2.211	2.315	2.416	2.519	2.622
3,00		370	478	583	691	796	903	1.010	1.116	1.222	1.328	1.457	1.566	1.674	1.783	1.917	2.026	2.136	2.244	2.354	2.463	2.571	2.682	2.791
3,20		391	505	618	731	844	957	1.071	1.183	1.297	1.409	1.546	1.661	1.776	1.892	2.032	2.148	2.264	2.379	2.496	2.613	2.728	2.844	2.960
3,40		412	532	652	772	890	1.011	1.133	1.251	1.371	1.490	1.633	1.756	1.877	1.999	2.147	2.269	2.393	2.515	2.638	2.761	2.883	3.006	3.129
3,60		431	559	684	812	938	1.065	1.193	1.318	1.446	1.571	1.722	1.850	1.978	2.108	2.262	2.392	2.521	2.651	2.781	2.911	3.038	3.169	3.299
3,80		452	585	719	852	986	1.120	1.254	1.387	1.520	1.653	1.810	1.946	2.082	2.216	2.377	2.514	2.651	2.785	2.922	3.059	3.195	3.330	3.467
4,00		472	614	753	894	1.033	1.174	1.314	1.454	1.594	1.734	1.898	2.039	2.183	2.324	2.492	2.635	2.780	2.921	3.064	3.209	3.350	3.494	3.637

Características de los tejidos

Tejido	Ancho de rollo (ml)	Sin termosoldadura	Con termosoldadura
031024 Soltis Perform 92	1,77	Alto x Ancho 4,00x1,77	Alto x Ancho 1,45x5,00
031024 Soltis Perform 92	2,67	Alto x Ancho 4,00x2,67	Alto x Ancho 2,35x5,00
031094 Soltis Proof W96	2,67	Alto x Ancho 4,00x2,67	Alto x Ancho 2,35x5,00
030420 Soltis Opaque B92	1,70	Alto x Ancho 4,00x1,70	Alto x Ancho 1,40x5,00
031145 Screen Elarus Black-Out	2,10	Alto x Ancho 4,00x2,10	Alto x Ancho 1,80x4,00

- A efectos de precio se redondeará a la inmediata superior.
- Los sistemas eje 44 y 65 están cotizados con accionamiento a cadena.
- Los sistemas eje de 65 llevan desmultiplicador.
- El sistema eje 65 y 80 no incluye accionamiento, deberá incrementar en el precio el accionamiento deseado (cardán o motor).

Límite de cambio de mecanismo simple a desmultiplicador.



Estor enrollable

Por defecto, las combinaciones de colores de los accesorios, en función de los tejidos empleados en nuestros Enrollables, son que le detallamos a continuación. Opcionalmente, sin incrementos, el cliente puede solicitar una combinación distinta si lo desea.

Color de los accesorios para cada tejido

Cód.	Tejido	Color	Cód.	Tejido	Color	Cód.	Tejido	Color	Cód.	Tejido	Color
2100	Sax 3000	Blanco	8204	Soltis H. 86	Blanco	2001	Soltis L. 96	Blanco	7940	Atlas	Grafito
2101	Sax 3000	Blanco	8255	Soltis H. 86	Blanco	2135	Soltis L. 96	Blanco	7941	Atlas	Negro
2102	Sax 3000	Marfil	50271	Soltis H. 86	Blanco	8056	Soltis L. 96	Blanco	1150	Deimos	Gris
2105	Sax 3000	Marfil	50261	Soltis H. 86	Blanco	50284	Soltis 99	Gris	7800	Fobos	Marrón
2106	Sax 3000	Marfil	50264	Soltis H. 86	Blanco	2058	Soltis 99	Gris	7820	Letho	Marrón
2110	Sax 3000	Marrón	50333	Soltis H. 86	Blanco	50288	Soltis 99	Gris	1350	Jano	Blanco
2111	Sax 3000	Marfil	50336	Soltis H. 86	Blanco	2059	Soltis 99	Gris	7720	Azur	Blanco
2112	Sax 3000	Blanco	50342	Soltis H. 86	Grafito	2044	Soltis 99	Blanco	7721	Azur	Negro
2113	Sax 3000	Blanco	2044	Soltis P. 92	Blanco	50301	Soltis 99	Blanco	7724	Azur	Marfil
2117	Sax 3000	Blanco	50274	Soltis P. 92	Blanco	2115	Soltis 99	Negro	1170	Ariel	Blanco
2118	Sax 3000	Blanco	2045	Soltis P. 92	Gris	2055	Soltis 99	Blanco	7920	Hidra	Blanco
2121	Sax 3000	Blanco	2135	Soltis P. 92	Blanco	50285	Soltis 99	Marfil	7921	Hidra	Marrón
2125	Sax 3000	Blanco	2175	Soltis P. 92	Marfil	50287	Soltis 99	Marfil	7922	Hidra	Negro
2126	Sax 3000	Blanco	2043	Soltis P. 92	Marrón	50286	Soltis 99	Blanco	7923	Hidra	Negro
2127	Sax 3000	Blanco	50272	Soltis P. 92	Gris	50299	Soltis 99	Blanco	7710	Stella	Blanco
2130	Sax 3000	Blanco	2171	Soltis P. 92	Gris	50289	Soltis 99	Blanco	1250	Hispa	Blanco
2131	Sax 3000	Blanco	2068	Soltis P. 92	Gris	50290	Soltis 99	Marrón	7860	Nimbus	Gris
2132	Sax 3000	Blanco	2046	Soltis P. 92	Gris	2073	Soltis 99	Grafito	7862	Nimbus	Gris
2135	Sax 3000	Marrón	2048	Soltis P. 92	Gris	2068	Soltis 99	Negro	7862	Nimbus	Gris
2136	Sax 3000	Gris	2051	Soltis P. 92	Gris	50292	Soltis 99	Blanco	7890	Kore	Marrón
2137	Sax 3000	Gris	50265	Soltis P. 92	Marfil	50293	Soltis 99	Blanco	7891	Kore	Blanco
2138	Sax 3000	Marrón	2163	Soltis P. 92	Blanco	50300	Soltis 99	Blanco	2401	Casablanca	Blanco
2139	Sax 3000	Negro	50266	Soltis P. 92	Marrón	50294	Soltis 99	Blanco	2407	Casablanca	Negro
2140	Sax 3000	Negro	2012	Soltis P. 92	Blanco	50291	Soltis 99	Blanco	12001	Shantung	Blanco
010	Bamboo	Marfil	50273	Soltis P. 92	Blanco	50295	Soltis 99	Blanco	12002	Shantung	Blanco
008	Bamboo	Marfil	2074	Soltis P. 92	Gris	50296	Soltis 99	Blanco	12003	Shantung	Marfil
003	Bamboo	Gris	2149	Soltis P. 92	Blanco	50297	Soltis 99	Blanco	12004	Shantung	Marfil
007	Bamboo	Marfil	2039	Soltis P. 92	Grafito	50298	Soltis 99	Blanco	12005	Shantung	Blanco
006	Bamboo	Marfil	2158	Soltis P. 92	Blanco	2501	Mimo	Blanco	12006	Shantung	Marfil
2900	Jávea	Blanco	8255	Soltis P. 92	Blanco	2502	Mimo	Marfil	12007	Shantung	Marfil
2901	Jávea	Marfil	2172	Soltis P. 92	Blanco	2503	Mimo	Marfil	12008	Shantung	Marfil
3300	Brasilia	Marfil	8204	Soltis P. 92	Blanco	2505	Mimo	Marrón	12009	Shantung	Blanco
3400	Altea	Blanco	2013	Soltis P. 92	Marfil	2506	Mimo	Marfil	12010	Shantung	Blanco
3401	Altea	Marfil	2166	Soltis P. 92	Blanco	2507	Mimo	Marrón	12013	Shantung	Blanco
3402	Altea	Marfil	2157	Soltis P. 92	Blanco	2516	Mimo	Blanco	12014	Shantung	Gris
2012	Soltis H. 86	Blanco	50333	Soltis P. 92	Blanco	2518	Mimo	Negro	12016	Shantung	Gris
2043	Soltis H. 86	Marrón	50264	Soltis P. 92	Blanco	2524	Mimo	Blanco	12018	Shantung	Blanco
2044	Soltis H. 86	Blanco	50271	Soltis P. 92	Blanco	2541	Mimo	Blanco	12019	Shantung	Blanco
2045	Soltis H. 86	Gris	50269	Soltis P. 92	Blanco	2543	Mimo	Blanco	12020	Shantung	Blanco
2046	Soltis H. 86	Gris	2160	Soltis P. 92	Blanco	2546	Mimo	Blanco	15001	Shantung-M1	Blanco
2047	Soltis H. 86	Grafito	50270	Soltis P. 92	Blanco	2547	Mimo	Blanco	15002	Shantung-M1	Blanco
2048	Soltis H. 86	Gris	2161	Soltis P. 92	Blanco	2548	Mimo	Gris	15003	Shantung-M1	Marfil
2053	Soltis H. 86	Negro	50342	Soltis P. 92	Grafito	2549	Mimo	Grafito	15005	Shantung-M1	Marfil
2068	Soltis H. 86	Gris	50268	Soltis P. 92	Blanco	2550	Mimo	Negro	15006	Shantung-M1	Gris
2135	Soltis H. 86	Blanco	2164	Soltis P. 92	Blanco	1253	Hispa	Blanco	4501	Screen 5500	Blanco
2148	Soltis H. 86	Marrón	50336	Soltis P. 92	Blanco	7880	Tiore	Marfil	4502	Screen 5500	Blanco
2158	Soltis H. 86	Blanco	50260	Soltis P. 92	Blanco	7881	Tiore	Blanco	4503	Screen 5500	Marfil
2161	Soltis H. 86	Blanco	50267	Soltis P. 92	Blanco	7791	Calipso	Marrón	4506	Screen 5500	Gris
2166	Soltis H. 86	Blanco	50261	Soltis P. 92	Blanco	7793	Calipso	Marfil	4507	Screen 5500	Blanco
2167	Soltis H. 86	Grafito	2137	Soltis P. 92	Marrón	7794	Calipso	Blanco	4508	Screen 5500	Gris
2171	Soltis H. 86	Gris	2148	Soltis P. 92	Marrón	1470	Anae	Marfil			
2175	Soltis H. 86	Marfil	2152	Soltis P. 92	Blanco	1471	Anae	Gris			



Estor enrollable

Por defecto, las combinaciones de colores de los accesorios, en función de los tejidos empleados en nuestros Estores enrollables, son que le detallamos a continuación. Opcionalmente, sin incrementos, se puede solicitar una combinación distinta si se desea.

Color de los accesorios para cada tejido

Cód.	Tejido	Color	Cód.	Tejido	Color	Cód.	Tejido	Color
4510	Screen 5500	Gris	5902	Screen Artemis	Marfil	1041	Herse Black-Out	Marfil
4511	Screen 5500	Marrón	5903	Screen Artemis	Gris	1042	Herse Black-Out	Gris
4512	Screen 5500	Negro	5904	Screen Artemis	Gris	1043	Herse Black-Out	Gris
3601	Screen 3600	Blanco	5905	Screen Artemis	Gris	1044	Herse Black-Out	Grafito
3602	Screen 3600	Blanco	5906	Screen Artemis	Grafito	6730	Umbriel	Blanco
3603	Screen 3600	Marfil	5907	Screen Artemis	Negro	6731	Umbriel	Blanco
3606	Screen 3600	Gris	1043	Soltis Opaque B92	Marrón	6710	Tebe	Blanco
3607	Screen 3600	Blanco	2171	Soltis Opaque B92	Gris	6711	Tebe	Blanco
3608	Screen 3600	Gris	1046	Soltis Opaque B92	Gris	6712	Tebe	Gris
3610	Screen 3600	Gris	1045	Soltis Opaque B92	Gris	6720	Arce	Marfil
3611	Screen 3600	Marrón	1044	Soltis Opaque B92	Blanco	6721	Arce	Blanco
3612	Screen 3600	Negro	2135	Soltis Opaque B92	Blanco	6722	Arce	Gris
7910	Cosmos Perla	Gris	1000	Black-Out	Marfil	7800	Fobos	Marrón
7911	Cosmos Perla	Grafito	1001	Black-Out	Blanco	7801	Fobos	Blanco
7912	Cosmos Perla	Marfil	1002	Black-Out	Gris	7802	Fobos	Gris
7913	Cosmos Perla	Negro	1003	Black-Out	Marfil	7803	Fobos	Gris
7900	Cosmos	Blanco	1004	Black-Out	Blanco	6700	Sax Screen Dione	Blanco
7901	Cosmos	Blanco	1005	Black-Out	Blanco	6701	Sax Screen Dione	Marfil
7903	Cosmos	Grafito	1006	Black-Out	Blanco	6702	Sax Screen Dione	Gris
7904	Cosmos	Gris	1007	Black-Out	Negro	6703	Sax Screen Dione	Gris
7905	Cosmos	Negro	4000	Screen Elarus Black-Out	Blanco	6704	Sax Screen Dione	Gris
4201	Screen 2165	Blanco	4001	Screen Elarus Black-Out	Marfil	6705	Sax Screen Dione	Gris
4202	Screen 2165	Gris	4002	Screen Elarus Black-Out	Marfil			
4203	Screen 2165	Gris	4003	Screen Elarus Black-Out	Blanco			
4204	Screen 2165	Grafito	4004	Screen Elarus Black-Out	Gris			
4210	Screen 2165	Marfil	4005	Screen Elarus Black-Out	Gris			
4211	Screen 2165	Marfil	4006	Screen Elarus Black-Out	Negro			
4212	Screen 2165	Marrón	9201	Darktex Black-Out	Blanco			
4213	Screen 2165	Marfil	9202	Darktex Black-Out	Blanco			
4219	Screen 2165	Gris	9203	Darktex Black-Out	Marfil			
4224	Screen 2165	Blanco	9204	Darktex Black-Out	Gris			
4226	Screen 2165	Blanco	9205	Darktex Black-Out	Gris			
4230	Screen 2165	Gris	9100	Berlín Black-Out	Blanco			
4231	Screen 2165	Marrón	9101	Berlín Black-Out	Blanco			
4232	Screen 2165	Grafito	9102	Berlín Black-Out	Marfil			
4233	Screen 2165	Negro	9103	Berlín Black-Out	Marfil			
4401	Screen 8505	Blanco	9104	Berlín Black-Out	Blanco			
4402	Screen 8505	Marfil	9106	Berlín Black-Out	Marrón			
4403	Screen 8505	Marfil	9107	Berlín Black-Out	Gris			
4405	Screen 8505	Gris	9108	Berlín Black-Out	Gris			
4406	Screen 8505	Gris	9109	Berlín Black-Out	Blanco			
4407	Screen 8505	Blanco	9110	Berlín Black-Out	Blanco			
4408	Screen 8505	Blanco	9111	Berlín Black-Out	Blanco			
4412	Screen 8505	Blanco	9112	Berlín Black-Out	Blanco			
4414	Screen 8505	Negro	9113	Berlín Black-Out	Negro			
4101	Screen Titan	Blanco	7950	Hiperion Black-Out	Marfil			
4102	Screen Titan	Blanco	7951	Hiperion Black-Out	Marrón			
4103	Screen Titan	Marfil	7952	Hiperion Black-Out	Negro			
4104	Screen Titan	Marfil	7953	Hiperion Black-Out	Marrón			
4105	Screen Titan	Gris	8001	Filtro Solar	Grafito			
4106	Screen Titan	Gris	1030	Leda Black-Out	Blanco			
4107	Screen Titan	Grafito	1031	Leda Black-Out	Marfil			
4108	Screen Titan	Grafito	1032	Leda Black-Out	Gris			
4109	Screen Titan	Negro	1033	Leda Black-Out	Gris			
5900	Screen Artemis	Blanco	1034	Leda Black-Out	Grafito			
5901	Screen Artemis	Blanco	1040	Herse Black-Out	Blanco			

*El terminal estándar es el modelo Slim.
Opcional: Si se desea puede solicitar una combinación distinta (sin incremento).*

Vision

Haz clic o escanea
para acceder a la ficha
de prescripción





Vision Sistema básico CLS

030935



Componentes

Nº	Cód.	Descripción	Nº	Cód.	Descripción
1	030757	Terminal aluminio redondo Vision CLS	7	030895	Soporte barra estabilizadora
2	030758	Tapón plástico terminal redondo Vision CLS	8	030801	Tope opuesto soporte metal Enrollable CLS
3	040083	Aro cadena PVC a 1,50	9	030919	Cápsula eje 35 mm CLS
4	030425	Tensor slim L	10	030918	Mecanismo Enrollable 1:1 S CLS
5	030808	Tapa lateral soporte enrollable M CLS	11	030920	Tubo aluminio Enrollable CLS 35
6	030807	Soporte metal enrollable M CLS	12	030894	Barra estabilizadora CLS

Medidas de fabricación

Máximos		Mínimos	
Ancho	2,40 m	Ancho	0,30 m
Alto	3,00 m	Alto	0,30 m



Vision Sistema semicajón CLS

030930

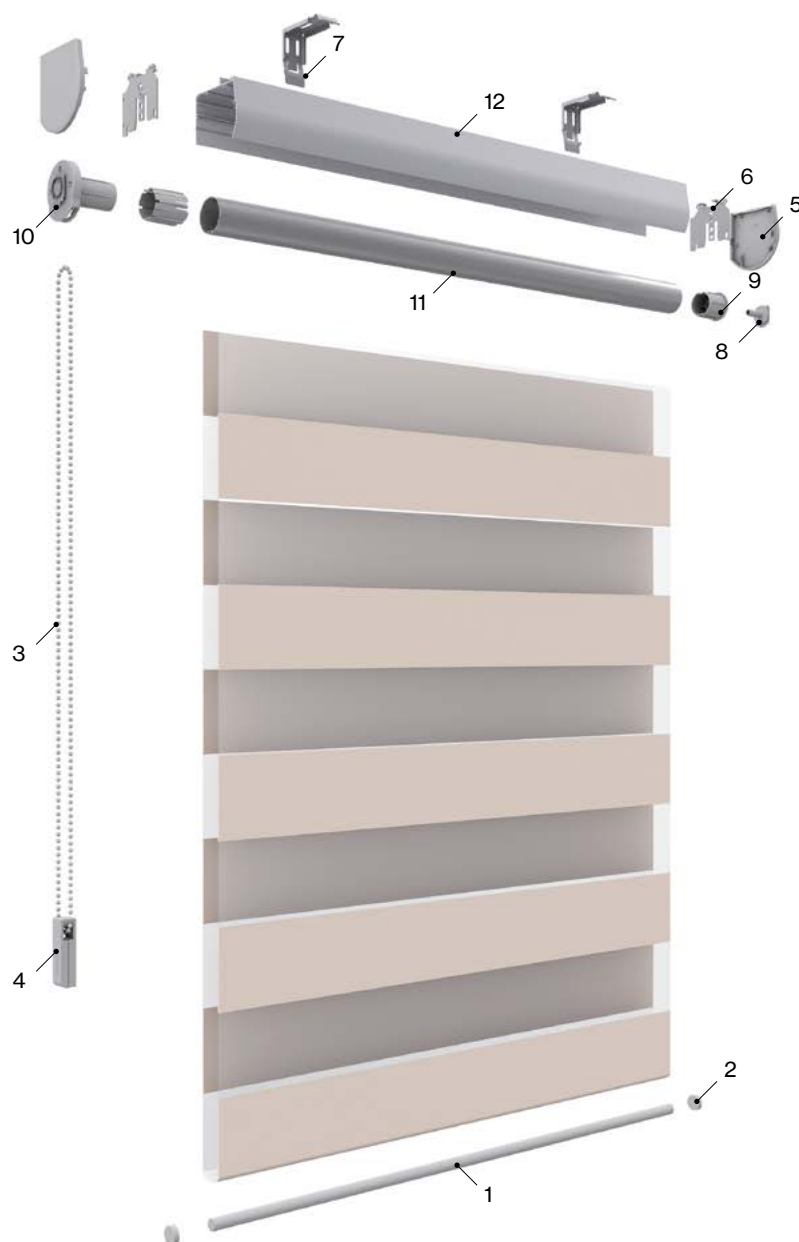

Componentes

Nº	Cód.	Descripción	Nº	Cód.	Descripción
1	030757	Terminal aluminio redondo Vision CLS	7	030875	Soporte semicajón 70
2	030758	Tapón plástico terminal redondo Vision CLS	8	030801	Tope opuesto soporte metal enrollable CLS
3	040083	Aro cadena PVC a 1,50	9	030919	Cápsula eje 35 mm CLS
4	030425	Tensor Slim L	10	030918	Mecanismo enrollable 1:1 S CLS
5	030881	Juego tapas laterales semicajón 70 M CLS	11	030920	Tubo de aluminio enrollable CLS 35
6	030876	Juego soportes metal cajón 70 CLS	12	030878	Semicajón de 70

Medidas de fabricación

Máximos		Mínimos	
Ancho	2,40 m	Ancho	0,30 m
Alto	3,00 m	Alto	0,30 m



Vision Sistema básico CLS

030935

Basic • Siroco • Prosper • Amaltea

Alto	Precio € ud										
	Ancho										
	0,60	0,80	1,00	1,20	1,40	1,60	1,80	2,00	2,20	2,40	2,60
1,00	105	130	155	179	205	230	254	278	305	329	353
1,20	116	144	174	201	230	258	288	315	344	371	396
1,40	128	160	192	224	255	288	320	351	383	414	438
1,60	139	175	210	245	279	315	352	388	422	458	482
1,80	151	190	228	267	306	345	383	422	462	501	526
2,00	161	205	247	289	331	374	415	459	501	543	567
2,20	173	217	265	311	355	403	447	495	541	585	610
2,40	185	232	283	331	382	430	481	530	580	630	654
2,60	194	248	301	353	407	460	514	566	619	672	696
2,80	206	263	320	375	431	489	545	601	658	715	738
3,00	216	277	337	397	458	518	578	637	697	758	782

Delta • Best • California • Black-Out • Larissa • Himalia

Alto	Precio € ud										
	Ancho										
	0,60	0,80	1,00	1,20	1,40	1,60	1,80	2,00	2,20	2,40	2,60
1,00	127	156	190	220	252	285	315	346	380	409	442
1,20	140	177	214	251	288	324	361	397	432	469	506
1,40	155	198	239	279	323	363	405	445	488	528	569
1,60	173	217	265	311	355	403	450	496	542	587	634
1,80	187	238	289	340	391	443	492	544	596	646	697
2,00	201	258	314	369	427	482	538	595	650	705	761
2,20	216	277	339	400	460	521	582	643	704	766	826
2,40	232	298	365	429	496	560	627	693	758	825	889
2,60	248	317	389	459	530	601	672	742	812	883	952
2,80	263	339	414	489	565	641	716	791	867	943	1.019
3,00	278	361	439	519	599	680	761	841	922	1.003	1.143

Vision Sistema Semicajón CLS

030930

Basic • Siroco • Prosper • Amaltea

Alto	Precio € ud										
	Ancho										
	0,60	0,80	1,00	1,20	1,40	1,60	1,80	2,00	2,20	2,40	2,60
1,00	118	150	178	209	237	267	296	327	355	384	414
1,20	131	163	197	230	263	296	329	363	394	428	457
1,40	141	178	215	252	289	325	362	399	434	470	500
1,60	153	193	235	274	314	354	393	434	476	515	544
1,80	166	209	252	296	340	383	428	470	515	558	587
2,00	176	224	270	317	366	413	460	507	555	601	630
2,20	187	238	289	340	391	442	492	543	595	645	674
2,40	199	253	307	362	415	470	526	580	634	690	719
2,60	210	268	327	383	442	500	558	616	674	733	761
2,80	220	283	344	406	467	529	591	653	713	775	805
3,00	232	298	363	428	492	558	622	688	753	819	848

Delta • Best • California • Black-Out • Larissa • Himalia

Alto	Precio € ud										
	Ancho										
	0,60	0,80	1,00	1,20	1,40	1,60	1,80	2,00	2,20	2,40	2,60
1,00	140	177	215	252	289	325	362	399	483	523	565
1,20	156	199	240	282	324	366	407	450	558	606	654
1,40	173	219	267	313	361	406	453	500	634	688	742
1,60	189	239	291	344	394	446	498	551	708	769	831
1,80	205	260	316	374	430	488	544	601	782	851	920
2,00	219	282	343	405	467	528	591	653	858	933	1.009
2,20	236	302	368	437	503	568	636	703	933	1.015	1.097
2,40	251	323	393	466	538	610	681	754	1.009	1.097	1.186
2,60	267	343	420	497	574	650	728	805	1.083	1.179	1.274
2,80	282	365	445	528	610	692	773	854	1.159	1.260	1.362
3,00	298	384	470	558	644	733	819	906	1.234	1.342	1.451

**Datos del tejido**

Código	Tejido (mínimo a facturar 1 ml)	Ancho Rollo (ml)	Precio metraje €
031026	Basic	2,40	31,00
031098	Siroco	2,00	31,00
031096	Delta	2,60	35,00
031059	Best	2,40	35,00
031095	California	2,40	35,00
031097	Black-Out	2,60	35,00
031146	Larissa	2,40	35,00
031147	Amaltea	2,60	43,00
031148	Himalia	2,60	31,00
031150	Prosper	2,40	31,00

• Mínimo a facturar 1 ml.

• El tejido California sólo se puede instalar en sistema semicajón de 90 hasta 1,80 ml de ancho con 2,50 ml de alto máximo. Si se desea un ancho superior a 1,80 ml, el alto máximo será de 1,60 ml.

Colores

Disponible en blanco y plata

• Accesorios y barra estabilizadora se suministran en blanco. Si se desea otra combinación, por favor, ha de indicarse en el pedido.

Sistema semicajón

Disponible en blanco y plata

• Accesorios y barra estabilizadora se suministran en blanco. Si se desea otra combinación, ha de indicarse en el pedido.

Incremento • Sistema básico • Lacado de perfiles

	Plata y lacado RAL	Lacado madera
Terminal	16,00	29,00
Barra estabilizadora	16,00	29,00

• Mínimo a facturar 1 ml

Incremento • Sistema semicajón • Lacado de perfiles

	Plata y lacado RAL	Lacado madera
Semicajón 70	22,00	47,00
Semicajón 90	22,00	47,00
Terminal	16,00	29,00

• Mínimo a facturar 1 ml

Por favor, tenga en cuenta:

- Precios para blanco.
- A efectos de precio se redondeará a la inmediata superior.
- Motorización y automatismos, **ver tarifa de Motores y Automatismos.**

Debido a las características del tejido no podemos garantizar la alineación de las franjas en el caso de instalarlas juntas.



Sistema semicajón 70



Sistema semicajón 90



Sistema básico barra estabilizadora

Perfiles

Semicajón 70

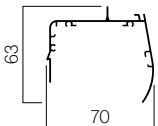

Semicajón 90

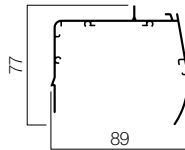

Barra estabilizadora

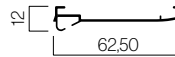

Terminal (estándar)



Terminal doble (opcional)
030516

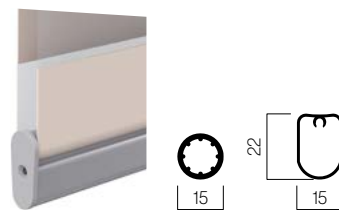

Por favor, tenga en cuenta:

- Precios para blanco.
- A efectos de precio se redondeará a la inmediata superior.
- Motorización y automatismos, **ver tarifa de Motores y Automatismos.**

Debido a las características del tejido no podemos garantizar la alineación de las franjas en el caso de instalarlas juntas.

Stor Glass

Intra y Extra

Haz clic o escanea
para acceder a la ficha
de prescripción

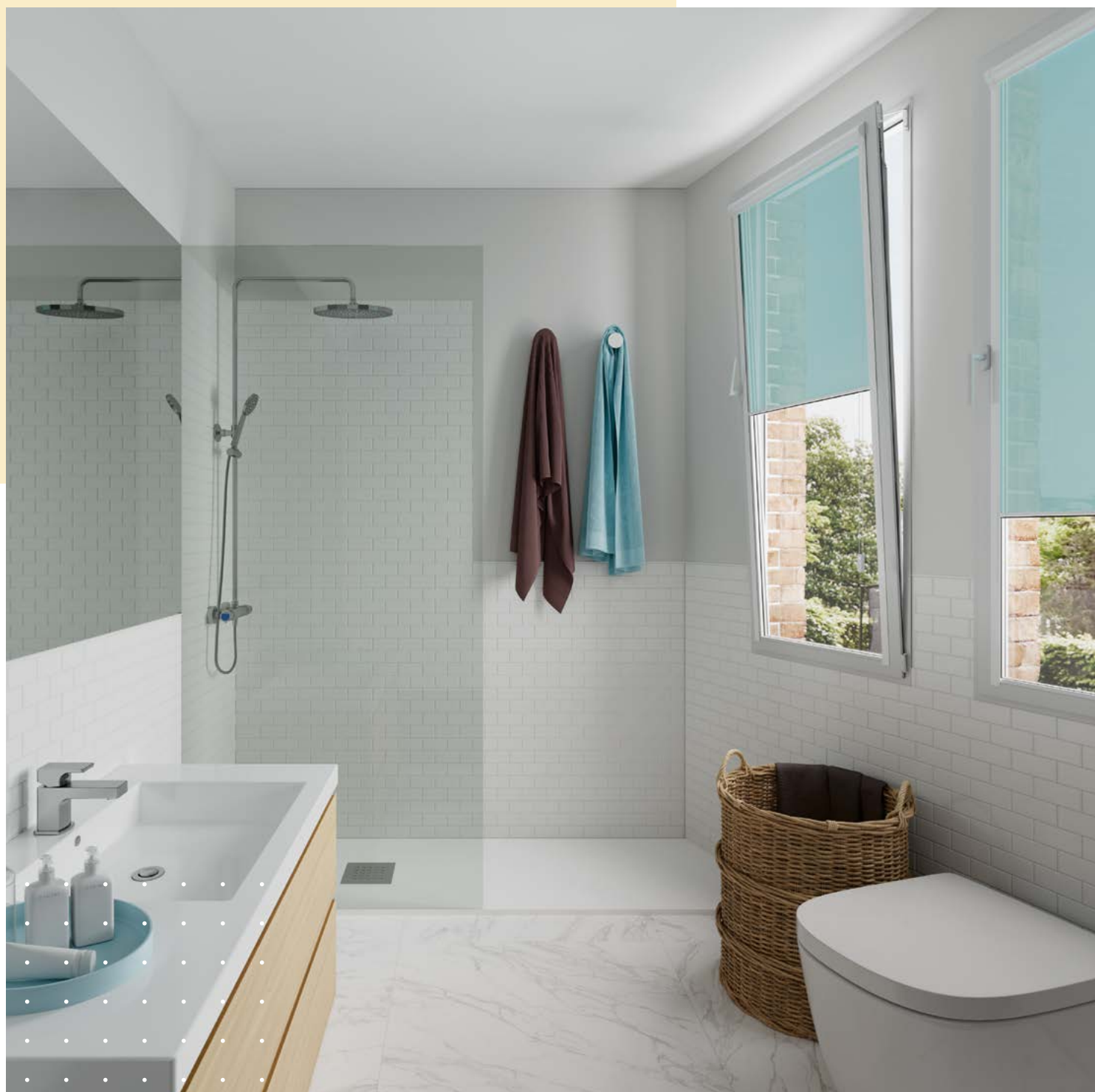



Stor Glass Intra

030049

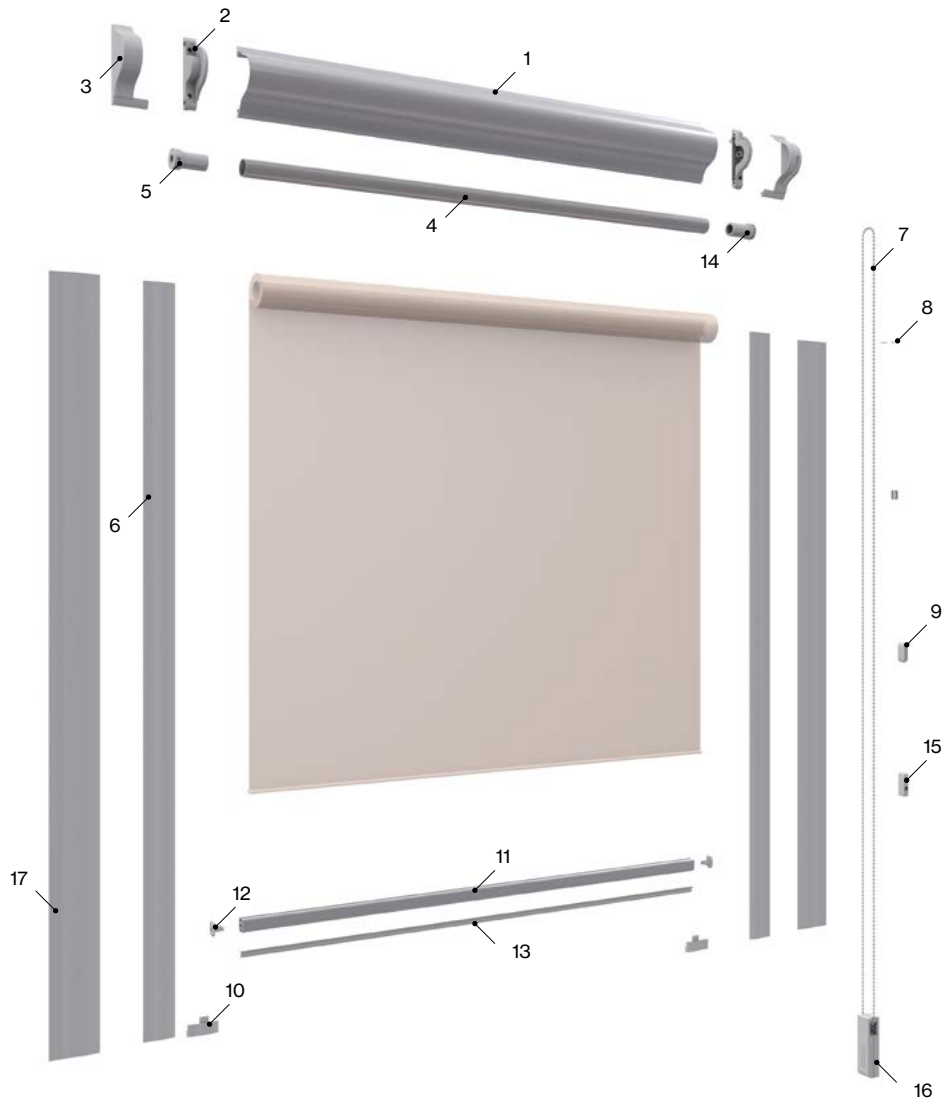

Componentes

Nº	Cód.	Descripción	Nº	Cód.	Descripción
1	030024	Cajón Stor Glass	10	030039	Tapón guía (sólo guía 33 mm)
2	030034	Juego testeros	11	030027	Terminal aluminio
3	030033	Embellededor	12	030041	Tapón terminal
4	030028	Eje 18 mm	13	030031	Goma estanca
5	030038	Cápsula	14	030037	Mecanismo
6	030025	Guía aluminio 33 mm	15	030047	Sujeción cadena
7	030042	Cadena PVC 3,2x6	16	030775	Tensor slim M
8	030044	Topes cadena	17	030946	Guía aluminio 50
9	030045	Unión cadena			

Medidas de fabricación

Máximos		Mínimos	
Ancho	1,20 m	Ancho	0,40 m
Alto	Según tejido	Alto	0,30 m



Stor Glass Intra

030049

Sax 3000 • Deimos • Calipso

		Precio € ud				
		Ancho				
Alto		0,40	0,60	0,80	1,00	1,20
1,00		92	101	112	121	129
1,20		99	110	118	129	138
1,40		108	116	128	138	148
1,60		114	124	136	147	156
1,80		121	133	143	155	167
2,00		128	139	152	163	176
2,20		135	148	160	174	186

Mimo • Fobos • Leda Black-Out
Herse Black-Out • Arce

		Precio € ud				
		Ancho				
Alto		0,40	0,60	0,80	1,00	1,20
1,00		95	106	117	129	139
1,20		102	115	128	139	152
1,40		110	124	137	150	163
1,60		117	133	147	161	175
1,80		125	140	155	171	186
2,00		133	150	166	182	198
2,20		140	159	176	192	210

Black-Out • Berlin Black-Out

		Precio € ud				
		Ancho				
Alto		0,40	0,60	0,80	1,00	1,20
1,00		98	109	121	133	143
1,20		105	117	131	143	155
1,40		114	128	140	154	169
1,60		122	137	152	167	181
1,80		129	144	161	177	193
2,00		137	154	173	189	206
2,20		144	163	181	200	217

Sax Screen 3600 1% 5% 10%

		Precio € ud				
		Ancho				
Alto		0,40	0,60	0,80	1,00	1,20
1,00		99	113	124	137	151
1,20		108	122	136	150	163
1,40		116	131	147	161	177
1,60		124	140	156	174	191
1,80		133	151	169	187	205

Darktex Black-Out

		Precio € ud				
		Ancho				
Alto		0,40	0,60	0,80	1,00	1,20
1,00		114	131	148	166	182
1,20		124	143	162	179	199
1,40		133	154	175	194	216
1,60		141	164	187	210	232
1,80		152	176	201	225	251

Medidas en m.

- Precios para blanco.
- A efectos de precio se redondeará a la inmediata superior.

Brasilia • Jávea • Screen Nimbus • Screen Kore • Cosmos Perla

		Precio € ud				
		Ancho				
Alto		0,40	0,60	0,80	1,00	1,20
1,00		109	124	141	160	176
1,20		117	137	156	176	194
1,40		129	151	171	192	214
1,60		138	162	186	210	232
1,80		150	175	200	227	252
2,00		159	187	215	243	270
2,20		169	199	229	260	290

Altea • Casablanca • Azur • Letho • Cosmos • Ariel
Jano • Tiore • Screen Artemis 1% 3% 5% • Sax Screen Dione

		Precio € ud				
		Ancho				
Alto		0,40	0,60	0,80	1,00	1,20
1,00		104	118	135	150	166
1,20		114	130	148	163	181
1,40		123	140	160	178	198
1,60		133	153	174	193	214
1,80		141	163	186	209	230
2,00		152	175	199	224	247
2,20		161	187	213	238	265

Soltis Harmony 88 • Soltis 99 • Soltis Lounge 96
Screen Titan • Screen 8505

		Precio € ud				
		Ancho				
Alto		0,40	0,60	0,80	1,00	1,20
1,00		113	130	148	163	181
1,20		123	141	161	181	200
1,40		133	154	176	198	219
1,60		143	167	191	214	238
1,80		153	178	205	231	256
2,00		163	192	219	248	275
2,20		175	205	235	265	293

Soltis Perform 92 • Soltis Proof W96 • Stella • Anae

		Precio € ud				
		Ancho				
Alto		0,40	0,60	0,80	1,00	1,20
1,00		121	141	162	185	205
1,20		133	156	179	205	229
1,40		143	171	198	225	252
1,60		155	186	215	245	275
1,80		168	200	232	267	299
2,00		179	215	251	288	323
2,20		191	230	268	307	346

Screen Elarus Black-Out • Soltis Opaque B92

		Precio € ud				
		Ancho				
Alto		0,40	0,60	0,80	1,00	1,20
1,00		131	156	184	209	235
1,20		144	174	204	232	262
1,40		156	190	224	256	290
1,60		169	206	243	279	316

Por favor, tenga en cuenta:

El alto máximo del tejido que se muestra en la página 60.



Stor Glass Extra

031400

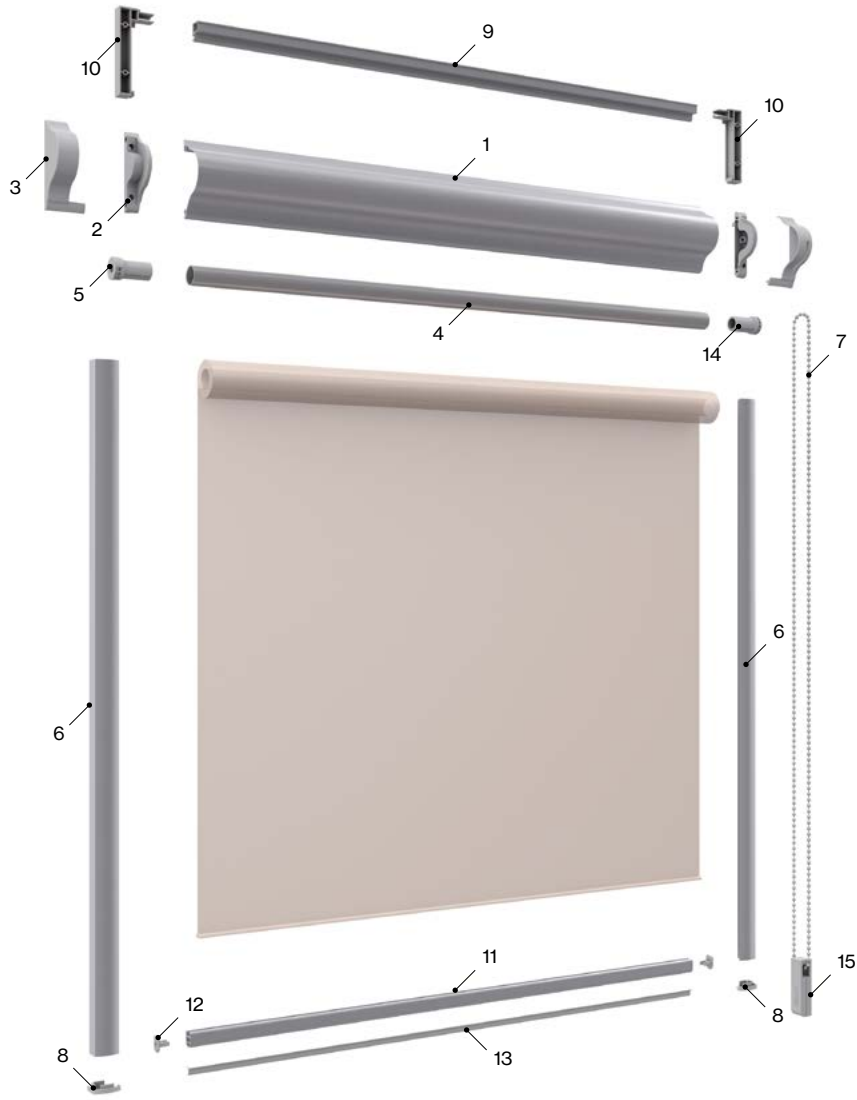

Componentes

Nº	Cód.	Descripción	Nº	Cód.	Descripción
1	030024	Cajón Stor Glass	9	031207	Perfil espaciador
2	030034	Juego testeros	10	031209	Juego esquina para espaciador
3	030033	Embellecedor	11	030027	Terminal aluminio
4	030028	Eje 18 mm	12	030041	Tapón terminal
5	030038	Cápsula	13	030031	Goma estanca
6	031208	Guía aluminio tipo C	14	030037	Mecanismo
7	030042	Cadena PVC 3,2x6	15	030775	Tensor slim M
8	031210	Juego tapón guía tipo C			

Medidas de fabricación

Máximos		Mínimos	
Ancho	1,20 m	Ancho	0,40 m
Alto	Según tejido	Alto	0,30 m



Stor Glass Extra

031400

Sax 3000 • Deimos • Calipso

Precio € ud						
Alto	Ancho					
	0,40	0,60	0,80	1,00	1,20	
1,00	100	110	121	130	140	
1,20	108	117	128	139	150	
1,40	114	125	137	147	159	
1,60	121	131	144	155	167	
1,80	127	139	152	163	176	
2,00	133	147	160	173	185	
2,20	140	153	167	179	193	

Mimo • Fobos • Leda Black-Out
Herse Black-Out • Arce

Precio € ud						
Alto	Ancho					
	0,40	0,60	0,80	1,00	1,20	
1,00	104	116	128	140	152	
1,20	112	124	137	151	163	
1,40	118	133	147	161	174	
1,60	127	140	155	169	185	
1,80	133	150	164	179	197	
2,00	140	156	174	190	206	
2,20	148	166	184	200	217	

Black-Out • Berlin Black-Out

Precio € ud						
Alto	Ancho					
	0,40	0,60	0,80	1,00	1,20	
1,00	105	117	130	141	154	
1,20	113	127	139	153	166	
1,40	121	135	150	163	177	
1,60	128	143	159	174	190	
1,80	136	152	168	185	201	
2,00	143	161	177	194	213	
2,20	151	168	187	205	224	

Sax Screen 3600 1% 5% 10%

Precio € ud						
Alto	Ancho					
	0,40	0,60	0,80	1,00	1,20	
1,00	106	121	133	147	161	
1,20	115	129	144	159	174	
1,40	123	138	154	169	186	
1,60	130	148	164	181	199	
1,80	138	156	175	192	212	

Darktex Black-Out

Precio € ud						
Alto	Ancho					
	0,40	0,60	0,80	1,00	1,20	
1,00	114	131	148	166	182	
1,20	124	143	162	179	199	
1,40	133	154	175	194	216	
1,60	141	164	187	210	232	
1,80	152	176	201	225	251	

Medidas en m.

- Precios para blanco.
- A efectos de precio se redondeará a la inmediata superior.

Brasilía • Jávea • Screen Nimbus • Screen Kore • Cosmos Perla

Precio € ud						
Alto	Ancho					
	0,40	0,60	0,80	1,00	1,20	
1,00	115	133	151	167	185	
1,20	125	144	163	184	202	
1,40	135	155	177	199	220	
1,60	144	167	191	214	238	
1,80	153	178	204	230	255	
2,00	163	190	217	245	274	
2,20	173	202	231	261	291	

Altea • Casablanca • Azur • Letho • Cosmos • Ariel • Jano •
Tiore • Screen Artemis 1% 3% 5% • Sax Screen Dione

Precio € ud						
Alto	Ancho					
	0,40	0,60	0,80	1,00	1,20	
1,00	112	127	143	159	174	
1,20	121	138	154	173	190	
1,40	129	148	167	186	205	
1,60	138	159	178	200	220	
1,80	147	168	191	214	236	
2,00	155	179	204	227	251	
2,20	164	190	215	240	266	

Soltis Harmony 88 • Soltis 99 • Soltis Lounge 96
Screen Titan • Screen 8505

Precio € ud						
Alto	Ancho					
	0,40	0,60	0,80	1,00	1,20	
1,00	117	137	155	175	193	
1,20	128	150	169	191	213	
1,40	138	162	185	209	231	
1,60	148	174	200	225	251	
1,80	159	186	214	242	270	
2,00	168	199	229	260	290	
2,20	178	212	243	276	308	

Soltis Perform 92 • Soltis Proof W96 • Stella • Anae

Precio € ud						
Alto	Ancho					
	0,40	0,60	0,80	1,00	1,20	
1,00	127	150	173	194	217	
1,20	138	164	190	216	242	
1,40	150	178	207	237	266	
1,60	162	193	227	258	291	
1,80	174	209	244	279	315	
2,00	185	224	262	300	339	
2,20	197	238	279	321	363	

Screen Elarus Black-Out • Soltis Opaque B92

Precio € ud						
Alto	Ancho					
	0,40	0,60	0,80	1,00	1,20	
1,00	131	156	184	209	235	
1,20	144	174	204	232	262	
1,40	156	190	224	256	290	
1,60	169	206	243	279	316	

Por favor, tenga en cuenta:

El alto máximo del tejido que se muestra en la página 60.



Stor Glass Intra y Extra

Colores Disponibles

Lacados estándar	Blanco
Lacados RAL • Anodizados	Plata, bronce, inox, 3005, 6005, 6009, 7012, 7016, 8014, 9011 mate y 9016 mate
Foliados	Golden y nogal oscuro
Accesorios	Blanco, gris y negro

• Cajón, guías y accesorios se entregan por defecto en blanco. Si deseas otra combinación, por favor indícalo en el pedido.
 • Colores en existencia sin incremento por mínimo de lacado, anodizado o foliado.

Incremento • Impresión digital

Tejidos impresión digital (mínimo 1,50 m ²)	Precio € m ²
Sobre el precio Sax 3000, Sax Screen 3600 1% 5%, Black-Out	66,00

• Sólo tejidos blancos.

Incremento • Lacado de perfiles

	Precio € ml			
	Plata lacado RAL	Anodizado	Lacado madera	Foliado golden y nogal
Cajón Stor Glass	22,00	39,00	48,00	47,00
Juego guías Stor Glass	16,00	33,00	40,00	40,00

• Mínimo a facturar 1 ml.

Datos del tejido

Tejido	Alto máximo	Tejido	Alto máximo	Tejido	Alto máximo
Sax 3000	2,20	Cosmos	2,20	Sax Screen 3600 10%	1,80
Deimos	1,50	Ariel	2,20	Soltis Perform 92	2,20
Calipso	2,20	Jano	2,20	Soltis Proof W96	2,20
Brasilia	2,20	Tiore	2,20	Stella	1,40
Jávea	1,60	Screen Artemis 1% 3%	2,00	Anae	2,00
Nimbus	1,80	Screen Artemis 5%	2,20	Darktex Black-Out	1,60
Kore	2,00	Black-Out	2,20	Screen Elarus Black-Out	1,40
Cosmos Perla	2,20	Berlin Black-Out	1,60	Soltis Opaque B92	1,60
Mimo	1,60	Soltis Harmony 88	2,20	Leda Black-Out	2,20
Fobos	1,20	Soltis 99	2,20	Herse Black-Out	2,20
Remo	2,20	Soltis Lounge 96	2,20	Sax Screen Dione	1,60
Altea	2,20	Screen Titan	1,80	Arce	2,00
Azur	1,60	Sax Screen 3600 1%	1,60		
Letho	1,00	Sax Screen 3600 5%	1,80		

Dimensiones del junquillo • Sistema Intra

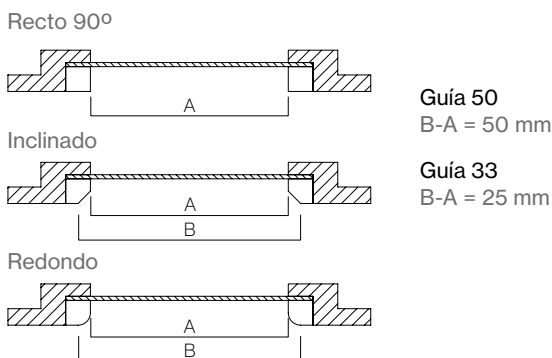

Tomar las medidas A y B según el tipo de junquillo. La diferencia entre ambas nunca podrá superar las medidas indicadas según el modelo de guía.

Dimensiones del junquillo • Sistema Extra

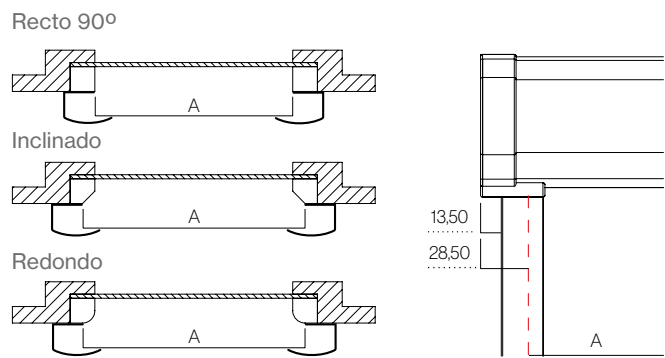

Para la fabricación es imprescindible tomar siempre la medida A. Tener en cuenta que el sistema Extra aumenta 28,50 mm en cada lado respecto la distancia A.

Profundidad del junquillo

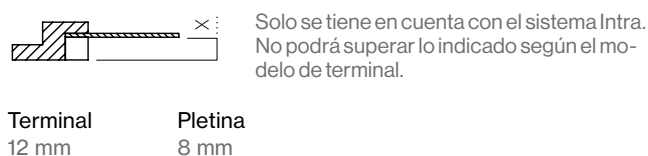

Solo se tiene en cuenta con el sistema Intra. No podrá superar lo indicado según el modelo de terminal.

Terminal 12 mm
Pletina 8 mm

Altura del junquillo

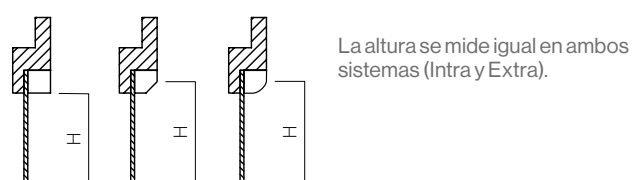

La altura se mide igual en ambos sistemas (Intra y Extra).



Stor Glass Avant a cadena

031500

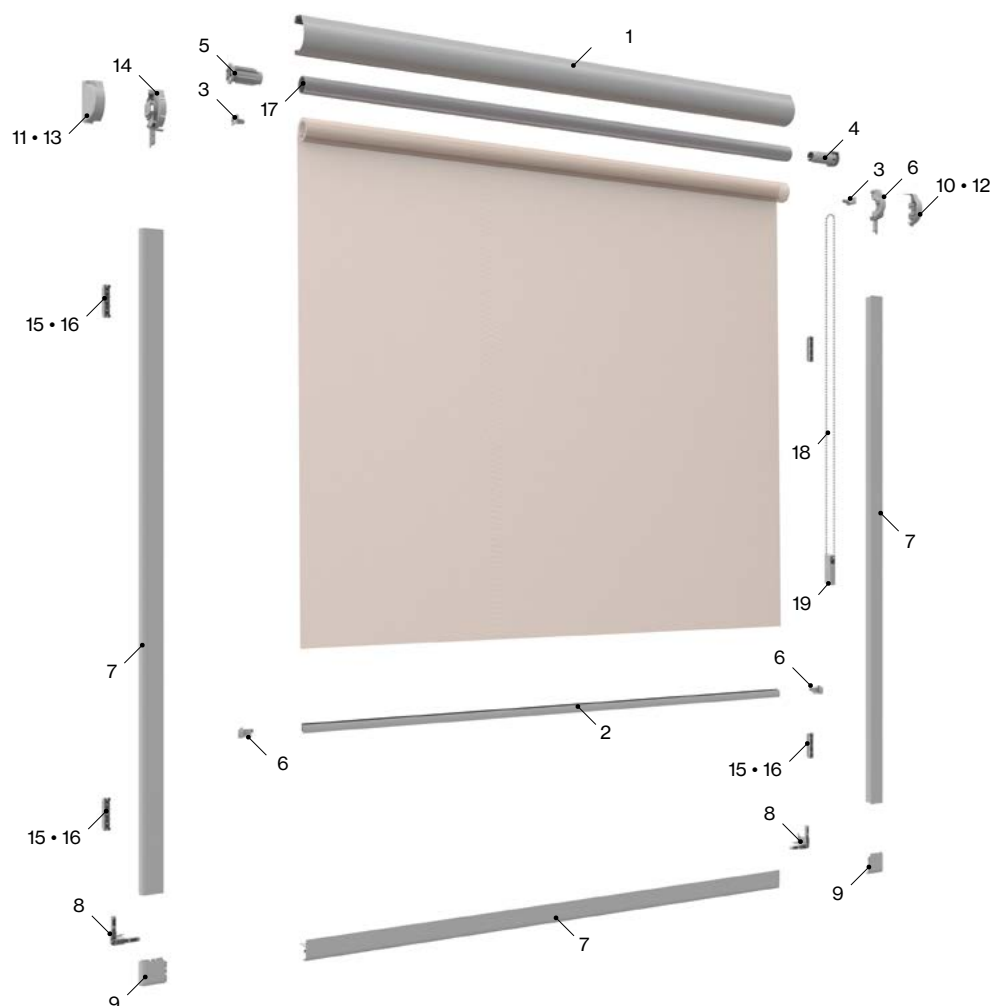

Componentes

Nº	Cód.	Descripción	Nº	Cód.	Descripción
1	031258	Cajon perfil 39 mm XS	11	031246	Cubierta cajon cadena derecha XS
2	031261	Contrapeso perfil XS	12	031247	Cubierta cajón muelle izquierda XS
3	031262	Pletina fijación XS	13	031248	Cubierta cajón muelle derecha XS
4	031263	Mecanismo enrollable XS cassette	14	031249	Testerero cajón guía 39 mm XS
5	031266	Tope final 19 mm XS	15	031251	Clip sujeción ventana XS
6	031280	Tope contrapeso XS	16	031253	Cinta sujeción ventana XS
7	031241	Perfil fácil ajuste 580 cm XS	17	031256	Tubo enrollable alu. con cinta doble
8	031242	Unión esquina XS	18	030042	Cadena PVC 3,2x6
9	031243	Cubierta esquina white ABS XS	19	030775	Tensor slim M
10	031245	Cubierta cajon cadena izqda. XS			

Medidas de fabricación

Máximos		Mínimos	
Ancho	1,20 m	Ancho	0,30 m
Alto	Según tejido	Alto	0,30 m



Stor Glass Avant a muelle

031500

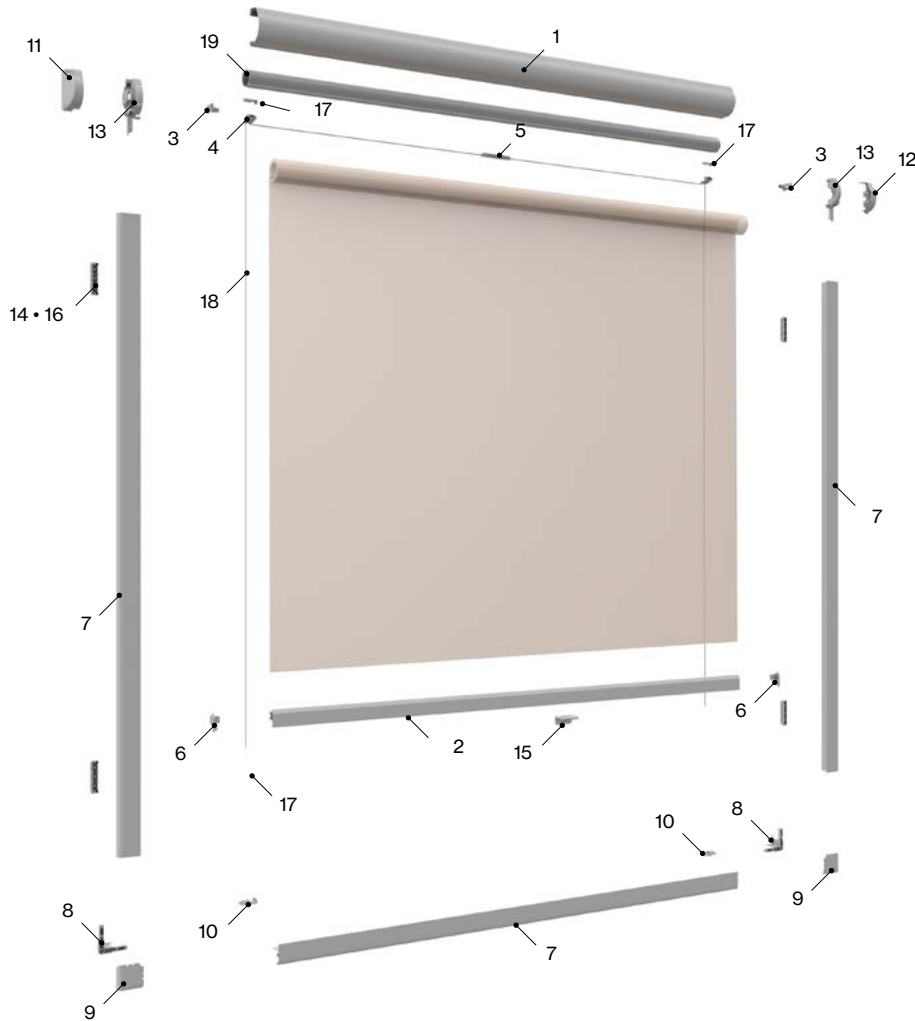

Componentes

Nº	Cód.	Descripción	Nº	Cód.	Descripción
1	031258	Cajon perfil 39 mm XS	11	031247	Cubierta cajon izquierda XS
2	031259	Contrapeso perfil tensionadoXS	12	031248	Cubierta cajon derecha XS
3	031262	Pletina fijación XS	13	031249	Cajon 39 mm marco interior XS
4	031277	Cable posicionador XS	14	031251	Clip sujección ventana XS
5	031278	Limitador muelle XS	15	031252	Maneta para PLC20XS
6	031279	Tope contrapeso tensionado XS	16	031253	Cinta sujección ventana XS
7	031241	Perfil facil ajuste 580 cm XS	17	031254	Tensor cordón sin pinza
8	031242	Unión esquina XS	18	029203	Cordón plisada 0,80
9	031243	Cubierta esquina white ABS XS	19	031256	Tubo enrollable alu. con cinta doble
10	031244	Tension shoe XS			

Medidas de fabricación

Máximos		Mínimos	
Ancho	1,20 m	Ancho	0,30 m
Alto	Según tejido	Alto	0,30 m



Stor Glass Avant

031500

Sax 3000 • Deimos • Calipso

Precio € ud						
Alto	Ancho					
	0,40	0,60	0,80	1,00	1,20	
1,00	100	110	121	130	140	
1,20	108	117	128	139	150	
1,40	114	125	137	147	159	
1,60	121	131	144	155	167	
1,80	127	139	152	163	176	
2,00	133	147	160	173	185	
2,20	140	153	167	179	193	

Mimo • Fobos • Leda Black-Out
Herse Black-Out • Arce

Precio € ud						
Alto	Ancho					
	0,40	0,60	0,80	1,00	1,20	
1,00	104	116	128	140	152	
1,20	112	124	137	151	163	
1,40	118	133	147	161	174	
1,60	127	140	155	169	185	
1,80	133	150	164	179	197	
2,00	140	156	174	190	206	
2,20	148	166	184	200	217	

Black-Out • Berlín Black-Out

Precio € ud						
Alto	Ancho					
	0,40	0,60	0,80	1,00	1,20	
1,00	105	117	130	141	154	
1,20	113	127	139	153	166	
1,40	121	135	150	163	177	
1,60	128	143	159	174	190	
1,80	136	152	168	185	201	
2,00	143	161	177	194	213	
2,20	151	168	187	205	224	

Sax Screen 3600 1% 5% 10%

Precio € ud						
Alto	Ancho					
	0,40	0,60	0,80	1,00	1,20	
1,00	106	121	133	147	161	
1,20	115	129	144	159	174	
1,40	123	138	154	169	186	
1,60	130	148	164	181	199	
1,80	138	156	175	192	212	

Darktex Black-Out

Precio € ud						
Alto	Ancho					
	0,40	0,60	0,80	1,00	1,20	
1,00	114	131	148	166	182	
1,20	124	143	162	179	199	
1,40	133	154	175	194	216	
1,60	141	164	187	210	232	
1,80	152	176	201	225	251	

Medidas en m.

- Precios para blanco.
- A efectos de precio se redondeará a la inmediata superior.

Brasilía • Jávea • Screen Nimbus • Screen Kore • Cosmos Perla

Precio € ud						
Alto	Ancho					
	0,40	0,60	0,80	1,00	1,20	
1,00	115	133	151	167	185	
1,20	125	144	163	184	202	
1,40	135	155	177	199	220	
1,60	144	167	191	214	238	
1,80	153	178	204	230	255	
2,00	163	190	217	245	274	
2,20	173	202	231	261	291	

Altea • Casablanca • Azur • Letho • Cosmos • Ariel • Jano •
Tiore • Screen Artemis 1% 3% 5% • Sax Screen Dione

Precio € ud						
Alto	Ancho					
	0,40	0,60	0,80	1,00	1,20	
1,00	112	127	143	159	174	
1,20	121	138	154	173	190	
1,40	129	148	167	186	205	
1,60	138	159	178	200	220	
1,80	147	168	191	214	236	
2,00	155	179	204	227	251	
2,20	164	190	215	240	266	

Soltis Harmony 88 • Soltis 99 • Soltis Lounge 96
Screen Titan • Screen 8505

Precio € ud						
Alto	Ancho					
	0,40	0,60	0,80	1,00	1,20	
1,00	117	137	155	175	193	
1,20	128	150	169	191	213	
1,40	138	162	185	209	231	
1,60	148	174	200	225	251	
1,80	159	186	214	242	270	
2,00	168	199	229	260	290	
2,20	178	212	243	276	308	

Soltis Perform 92 • Soltis Proof W96 • Stella • Anae

Precio € ud						
Alto	Ancho					
	0,40	0,60	0,80	1,00	1,20	
1,00	127	150	173	194	217	
1,20	138	164	190	216	242	
1,40	150	178	207	237	266	
1,60	162	193	227	258	291	
1,80	174	209	244	279	315	
2,00	185	224	262	300	339	
2,20	197	238	279	321	363	

Screen Elarus Black-Out • Soltis Opaque B92

Precio € ud						
Alto	Ancho					
	0,40	0,60	0,80	1,00	1,20	
1,00	131	156	184	209	235	
1,20	144	174	204	232	262	
1,40	156	190	224	256	290	
1,60	169	206	243	279	316	

Por favor, tenga en cuenta:

El alto máximo del tejido que se muestra en la página 64.



Stor Glass Avant

Colores disponibles

Lacados estándar	Blanco
Lacados RAL y Anodizados	Plata, bronce, inox, 3005, 6005, 6009, 7012, 7016, 8014, 9011 y 9016 mate
Foliados	Golden y nogal oscuro
Accesorios	Blanco, gris y negro

• Cajón, guías y accesorios se entregan por defecto en blanco. Si deseas otra combinación, por favor indícalo en el pedido.
 • Colores en existencia sin incremento por mínimo de lacado, anodizado o foliado.

Incremento • Impresión digital

Tejidos impresión digital (mínimo 1,50 m ²)	Precio € m ²
Sobre el precio Sax 3000, Sax Screen 3600 1% 5%, Black-Out	66,00
Incremento por accionamiento muelle (altura máxima 1,60 m)	40,00

• Sólo tejidos blancos.

Incremento • Lacado de perfiles

	Plata lacado RAL	Anodizado	Lacado madera	Foliado golden y nogal
Cajón Stor Glass Avant	22,00	39,00	48,00	47,00
Guías Stor Glass Avant	8,00	15,00	21,00	21,00

• Mínimo a facturar 1 ml.

Datos del tejido

Tejido	Alto máximo	Tejido	Alto máximo	Tejido	Alto máximo
Sax 3000	2,20	Ariel	2,20	Sax Screen 3600 10%	1,80
Deimos	1,50	Jano	2,20	Soltis Perform 92	2,20
Calipso	2,20	Tiore	2,20	Soltis Proof W96	2,20
Brasilia	2,20	Screen Artemis 1% 3%	2,00	Stella	1,40
Jávea	1,60	Screen Artemis 5%	2,20	Anae	2,00
Nimbus	1,80	Black-Out	2,20	Darktex Black-Out	1,80
Kore	2,00	Berlin Black-Out	1,60	Screen Elarus Black-Out	1,40
Cosmos Perla	2,20	Soltis Harmony 88	2,20	Soltis Opaque B92	1,60
Mimo	1,60	Soltis 99	2,20	Leda Black-Out	2,20
Fobos	1,20	Soltis Lounge 96	2,20	Herse Black-Out	2,20
Altea	2,20	Screen Titan	1,80	Sax Screen Dione	1,60
Casablanca	2,20	Screen 8505	1,80	Arce	1,20
Azur	1,60	Screen 8505	1,80		
Letho	1,00	Sax Screen 3600 1%	1,60		
Cosmos	2,20	Sax Screen 3600 5%	1,80		

Dimensiones del junquillo • Sistema Avant

Recto 90°

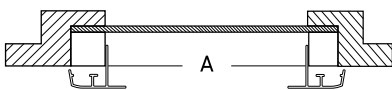

Guía
B-A = 20 mm

Inclinado

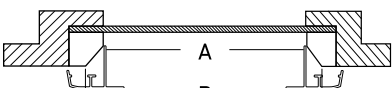

Tomar las medidas A y B según el tipo de junquillo. La diferencia entre ambas nunca podrá superar las medidas indicadas según el modelo de guía.

Redondo

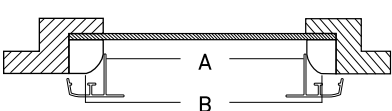

Para la fabricación es imprescindible tomar siempre la medida A

Dimensiones del junquillo • Sistema Avant

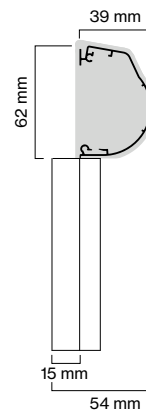

Perfil guía

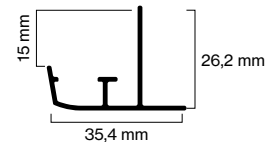

Profundidad del junquillo

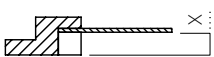

Solo se tiene en cuenta con el sistema Avant.

X*: Profundidad mayor o igual a 15 mm.

Altura del junquillo

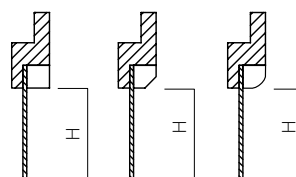

Cortina horizontal

Haz clic o escanea para acceder a la ficha de prescripción





Cortina horizontal

030650

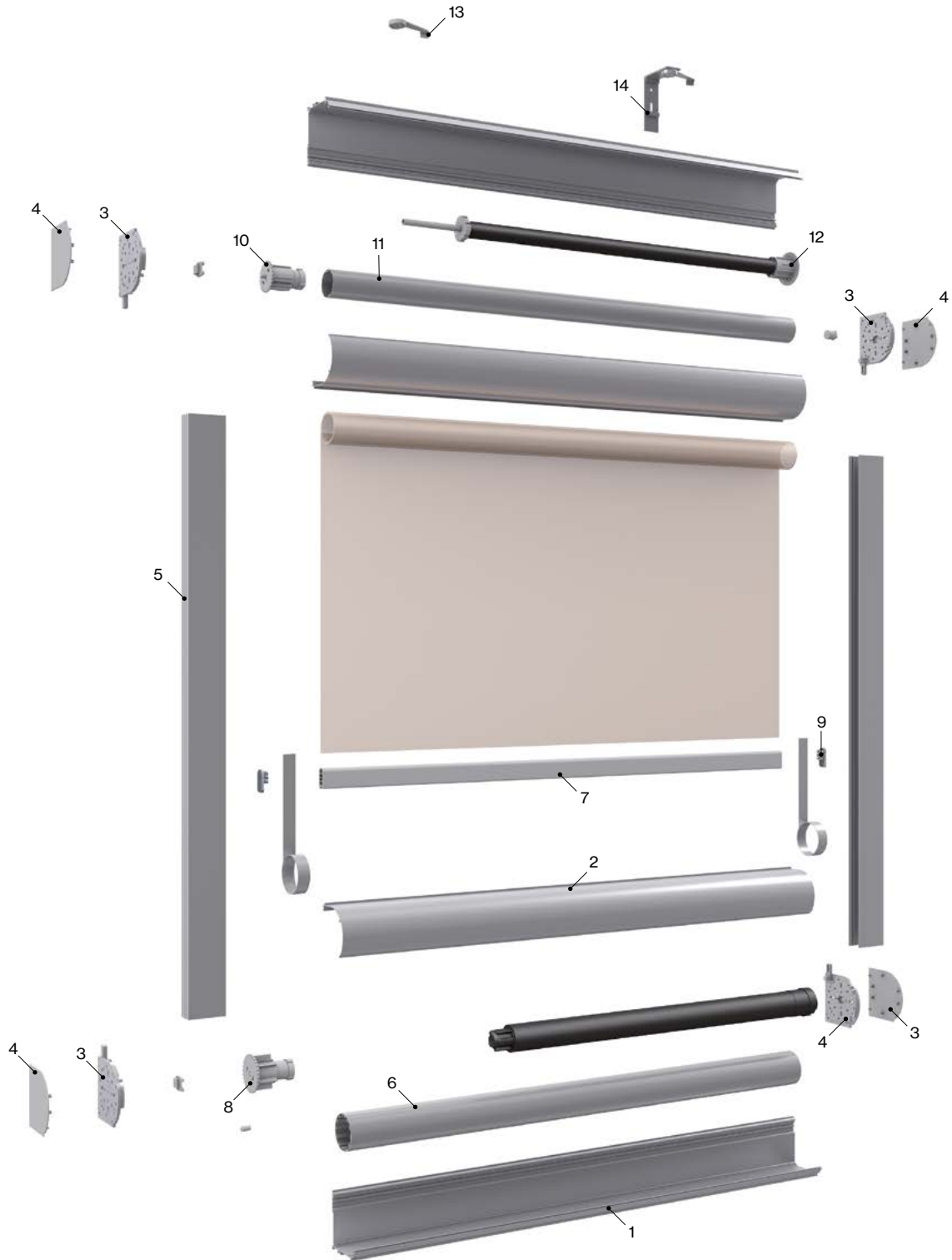

Componentes

Nº	Cód.	Descripción	Nº	Cód.	Descripción
1	001206	Perfil angular Saxun Box 92	8	030404	Contera eje de 50/60
2	001207	Perfil tapa Saxun Box 92	9	030312	Tapón terminal plano
3	030229	Jgo. testero c/enlace Saxun Box 92	10	030403	Contera eje de 45
4	030218	Jgo. tapas testero Saxun Box 92	11	030501	Eje aluminio 45
5	030076	Guía 60x27	12	030640	Muelle sistema Veranda 45
6	030506	Eje aluminio 60	13	030477	Soporte techo
7	030580	Terminal plano contrapeso	14	030233	Soporte pared



Cortina horizontal

030650

Black-Out • Berlin Black-Out

Precio € ud						
Alto	Ancho					
	0,60	0,80	1,00	1,20	1,40	1,60
1,00	313	383	455	527	597	669
1,20	342	419	496	573	652	729
1,40	369	453	538	620	704	788
1,60	399	488	578	668	757	848
1,80			619	715	811	907
2,00			659	761	864	965
2,20			699	808	915	1.025

Sax Screen 3600 1% 5% 10%

Precio € ud						
Alto	Ancho					
	0,60	0,80	1,00	1,20	1,40	1,60
1,00	313	383	455	527	597	669
1,20	342	419	496	573	652	729
1,40	369	453	538	620	704	788
1,60	399	488	578	668	757	848
1,80			619	715	811	907
2,00			659	761	864	965
2,20			699	808	915	1.025

Artemis 1% 3% 5%

Precio € ud						
Alto	Ancho					
	0,60	0,80	1,00	1,20	1,40	1,60
1,00	320	392	467	541	614	685
1,20	350	429	509	591	670	750
1,40	380	466	554	641	728	813
1,60	408	503	596	690	784	876
1,80			639	738	838	940
2,00			682	789	896	1.003
2,20			726	838	952	1.066

Soltis Lounge 92 • Soltis Proof W96

Precio € ud						
Alto	Ancho					
	0,60	0,80	1,00	1,20	1,40	1,60
1,00	359	445	532	619	705	792
1,20	397	492	589	684	781	875
1,40	434	541	645	750	856	961
1,60	472	587	700	817	930	1.045
1,80			758	882	1.006	1.128
2,00			813	948	1.080	1.213
2,20			871	1.012	1.155	1.298

Cardán Motor

- Precios para blanco.
- A efectos de precio se redondeará a la inmediata superior.
- No incluye accionamiento.



Cortina horizontal

Soltis Opaque B92 • Screen Elarus Black-Out

		Precio € ud				
Alto	Ancho					
	0,60	0,80	1,00	1,20	1,40	1,60
1,00	397	496	595	693	792	890
1,20	442	553	662	774	884	995
1,40	485	610	733	854	978	1.099
1,60	532	666	799	935	1.070	1.203
1,80			869	1.015	1.162	1.308
2,00			938	1.096	1.254	1.412
2,20			1.007	1.176	1.346	1.515

Cardán Motor

Medidas en m.

Perfiles

Saxun Box 92 curvo

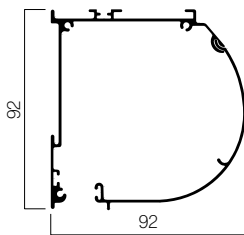

Guía 60x27

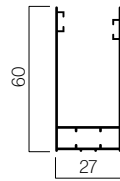

Terminal plano

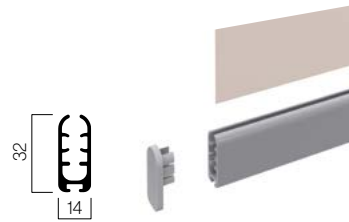

Colores

Disponible en blanco y plata

• Accesorios y barra estabilizadora se suministran en blanco. Si se desea otra combinación, ha de indicarse en el pedido.

Incremento • Lacado de perfiles

	Plata y lac. RAL	Anodizado	Lac.madera
Jgo. cajón Saxun Box 92	67,00	104,00	130,00
Terminal	16,00	25,00	29,00
Juego guías	25,00	36,00	47,00

• Precios para blanco.
• A efectos de precio se redondeará a la inmediata superior.
• No incluye accionamiento.

• Mínimo a facturar 1 ml.
• Motorización y automatismos, **ver tarifa de Motores y Automatismos.** 卍
• Cardán, ver página 35.

Cortina vertical

Haz clic o escanea
para acceder a la ficha
de prescripción





Cortina vertical 89 y 127

034201 • 034202

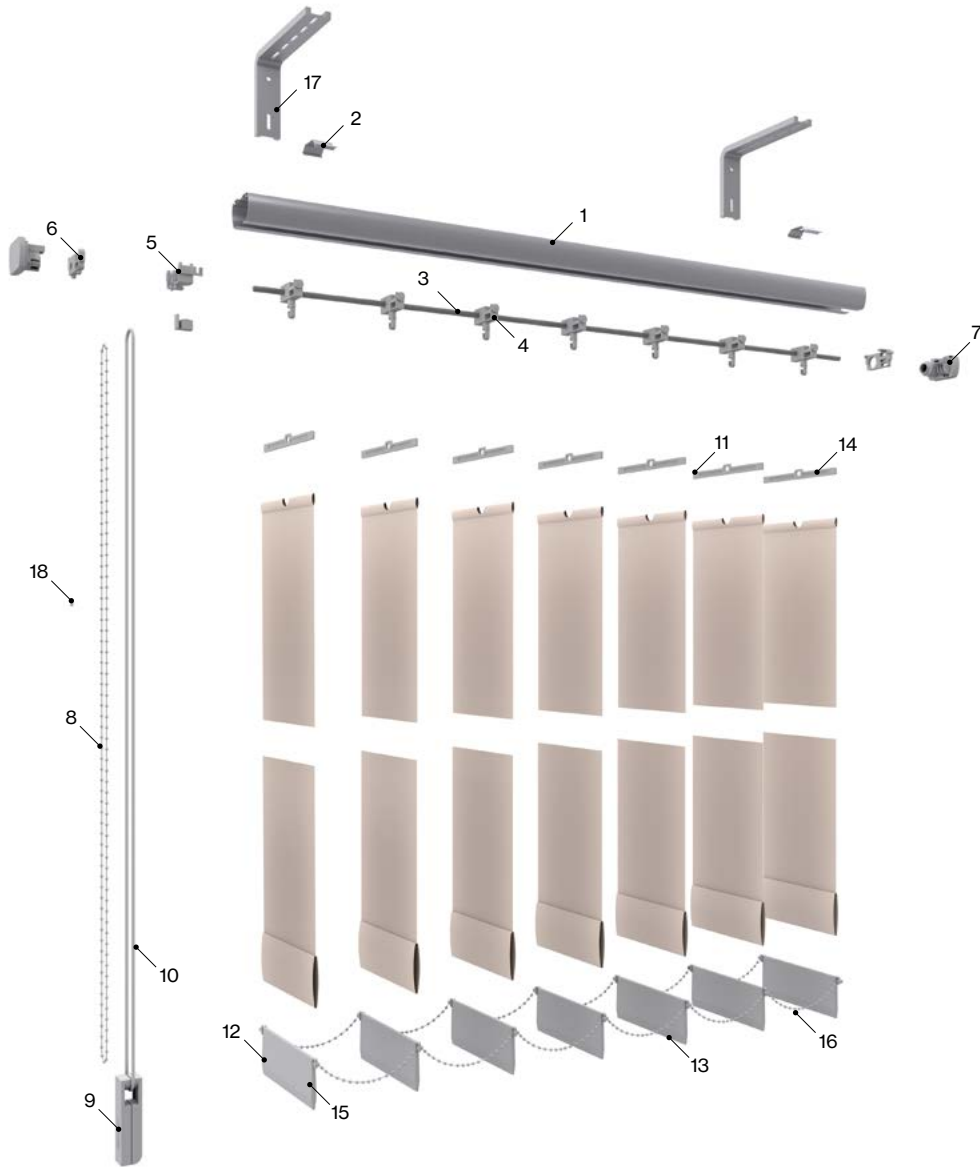

Componentes

Nº	Cód.	Descripción	Nº	Cód.	Descripción
1	034267	Riel vertical redondo CLS	10	034022	Cordón
2	034222	Soporte riel vertical	11	034045	Percha plástico 89
3	029159	Eje 3 vías	12	034043	Contrapeso de 89
4	034221	Carro 3 vías gancho CLS	13	034047	Cadena distanciadora 89
5	034217	Carro arrastre CLS	14	034046	Percha plástico 127
6	034279	Ventana de cristal laminado 180x300 mm	15	034044	Contrapeso de 127
7	034224	Tapadera lado contrario CLS	16	034023	Cadena distanciadora 127
8	030483	Cadena mando 3,8x9 mm	17	034048	Escuadra 10 cm
9	030426	Tensor slim XL	18	030603	Conector cadena 3,8x9 mm CLS

Medidas de fabricación

Máximos		Mínimos	
Ancho	5,80 m	Ancho	0,13 m
Alto	4,00 m	Alto	0,27 m
Inclinación	≤ 50°		



Cortina vertical 89

034201

Sax 3000 • Shantung • Calipso

Precio € ud

Alto	Ancho															
	1,00	1,20	1,40	1,60	1,80	2,00	2,20	2,40	2,60	2,80	3,00	3,20	3,40	3,60	3,80	4,00
1,00	140	152	160	169	179	191	201	212	222	230	240	251	262	273	283	292
1,20	144	155	164	176	186	199	209	222	231	242	252	263	275	286	298	308
1,40	150	161	171	182	194	206	219	230	243	252	265	276	289	300	313	325
1,60	153	164	176	187	201	214	227	240	252	263	275	289	300	314	328	339
1,80	156	171	181	194	207	222	236	250	263	274	288	300	314	328	342	355
2,00	161	176	186	200	215	229	244	260	273	285	298	313	328	342	357	370
2,20	164	179	192	206	222	238	252	268	283	294	311	325	340	355	371	386
2,40	169	185	198	214	229	245	262	277	293	306	321	338	354	370	386	403
2,60	174	189	202	219	237	252	269	288	304	316	332	351	366	383	401	417
2,80	177	194	207	225	243	261	277	296	314	328	344	362	380	397	416	432
3,00	181	200	214	230	250	268	288	306	323	338	355	375	393	412	430	447
3,20	185	204	219	238	255	276	294	315	334	350	367	386	406	426	445	465
3,40	189	209	224	244	265	285	305	325	344	359	380	400	420	440	460	480
3,60	193	214	229	250	270	291	313	334	354	370	390	412	431	453	475	495
3,80	198	219	236	255	277	299	320	343	365	381	403	424	445	467	490	511
4,00	201	224	240	262	285	307	330	353	375	392	413	437	459	482	505	527

Black-Out • Shantung-M1 • Berlin Black-Out

Precio € ud

Alto	Ancho															
	1,00	1,20	1,40	1,60	1,80	2,00	2,20	2,40	2,60	2,80	3,00	3,20	3,40	3,60	3,80	4,00
1,00	156	171	181	197	212	227	239	254	269	279	294	308	324	339	353	368
1,20	163	179	192	209	224	239	255	273	289	301	316	331	348	365	381	397
1,40	173	190	201	219	237	254	273	290	307	320	337	354	371	390	407	426
1,60	178	198	213	231	251	269	289	307	327	340	359	380	399	417	437	455
1,80	187	207	222	243	263	285	305	325	345	361	381	403	422	443	463	483
2,00	193	216	231	254	276	298	321	343	365	381	403	426	446	468	491	514
2,20	201	225	243	266	290	313	336	361	383	401	424	447	470	495	519	542
2,40	209	235	252	277	302	328	352	378	403	420	445	470	496	521	545	572
2,60	216	244	263	289	315	342	368	394	421	440	467	495	520	546	574	599
2,80	225	252	273	301	328	355	384	413	442	460	489	518	544	573	601	630
3,00	231	262	282	312	342	370	401	430	460	481	509	541	569	598	628	658
3,20	239	270	292	324	354	386	417	447	480	501	532	564	595	624	657	688
3,40	247	278	302	334	367	400	432	466	498	520	554	585	619	652	683	716
3,60	254	289	313	346	381	414	447	483	518	541	574	610	643	677	711	746
3,80	262	298	323	357	393	429	465	500	536	560	596	633	668	703	738	774
4,00	269	306	331	369	406	444	481	518	555	581	618	656	692	730	767	804

Sax Screen 3600 1% 5%

Precio € ud

Alto	Ancho															
	1,00	1,20	1,40	1,60	1,80	2,00	2,20	2,40	2,60	2,80	3,00	3,20	3,40	3,60	3,80	4,00
1,00	163	179	191	207	224	239	255	270	288	299	315	331	346	363	380	394
1,20	173	191	204	220	238	256	275	292	311	323	342	359	376	393	412	429
1,40	181	201	215	235	254	274	293	313	332	346	367	386	405	426	444	465
1,60	191	212	228	250	269	291	313	334	354	370	391	413	434	457	478	498
1,80	199	222	239	263	286	308	331	354	378	393	417	442	465	488	509	534
2,00	209	232	251	276	301	327	351	375	401	419	443	468	492	519	543	567
2,20	216	244	263	290	316	343	369	397	424	442	468	496	522	547	576	603
2,40	227	254	275	304	331	361	389	417	445	466	495	522	551	580	607	636
2,60	236	266	288	316	346	378	407	439	468	490	520	549	581	611	642	672
2,80	244	276	299	330	363	394	427	459	491	514	545	578	610	642	674	707
3,00	253	288	311	344	378	412	445	480	514	538	572	605	639	673	707	741
3,20	262	298	323	357	393	429	466	501	536	560	597	633	669	704	738	775
3,40	270	308	334	371	408	446	484	521	559	584	622	659	697	735	772	810
3,60	279	320	346	386	426	465	504	543	582	610	649	688	728	767	806	845
3,80	289	330	359	400	440	481	522	564	604	633	674	715	756	797	837	877
4,00	298	342	369	413	457	498	542	583	627	657	699	742	785	827	871	913



Cortina vertical 89

034201

Screen 8505 • Altea • Darktex Black-Out • Cosmos • Screen Artemis 1% 3% 5%

Precio € ud

Alto	Ancho															
	1,00	1,20	1,40	1,60	1,80	2,00	2,20	2,40	2,60	2,80	3,00	3,20	3,40	3,60	3,80	4,00
1,00	190	212	227	248	269	290	312	332	354	369	391	412	432	455	477	497
1,20	205	229	245	269	293	317	343	366	390	407	431	457	480	504	528	553
1,40	217	245	265	291	317	345	371	400	427	445	472	500	527	554	581	606
1,60	232	263	283	313	343	371	403	431	462	483	514	543	573	603	633	661
1,80	247	279	302	334	368	401	432	466	498	521	554	585	619	652	684	718
2,00	262	296	321	357	392	428	463	498	535	559	595	630	666	700	736	772
2,20	275	314	340	380	417	455	495	532	569	597	635	674	712	750	789	827
2,40	290	330	359	401	442	483	523	565	606	635	675	718	758	799	840	882
2,60	304	348	378	422	466	509	554	598	642	673	716	760	805	849	894	936
2,80	317	366	397	444	491	538	584	631	679	711	758	805	851	897	945	991
3,00	331	382	415	466	516	565	615	665	715	749	798	848	897	948	998	1.047
3,20	346	400	434	488	541	593	645	697	750	787	838	892	944	997	1.049	1.102
3,40	361	415	453	508	565	620	675	731	787	825	881	935	990	1.047	1.102	1.156
3,60	375	432	472	530	589	646	705	762	821	863	921	979	1.037	1.096	1.153	1.212
3,80	389	451	491	553	615	675	736	797	858	900	961	1.022	1.083	1.143	1.205	1.267
4,00	404	467	509	576	639	703	767	830	895	938	1.002	1.065	1.129	1.194	1.257	1.320

Brasilia • Cosmos Perla

Precio € ud

Alto	Ancho															
	1,00	1,20	1,40	1,60	1,80	2,00	2,20	2,40	2,60	2,80	3,00	3,20	3,40	3,60	3,80	4,00
1,00	206	231	248	273	298	323	346	370	394	413	438	462	485	509	536	560
1,20	224	252	273	299	328	355	383	412	440	459	488	516	543	572	599	628
1,40	240	273	294	327	357	390	421	452	483	506	538	568	601	633	662	695
1,60	258	293	317	353	389	424	458	492	528	553	587	622	658	693	728	761
1,80	276	314	342	381	419	457	496	534	573	598	637	675	715	753	792	830
2,00	293	336	365	406	447	490	532	574	616	645	688	730	772	813	856	897
2,20	312	355	389	432	480	523	569	616	660	692	737	784	829	874	920	965
2,40	329	378	412	460	508	558	606	657	705	738	788	836	886	934	984	1.033
2,60	346	399	434	488	539	592	644	697	750	785	837	890	943	995	1.048	1.101
2,80	363	420	458	514	569	624	682	737	794	831	888	944	1.001	1.057	1.111	1.167
3,00	381	440	481	541	599	659	719	779	837	877	938	998	1.058	1.117	1.176	1.235
3,20	399	462	505	567	631	693	757	819	883	925	988	1.050	1.114	1.176	1.240	1.302
3,40	415	482	528	595	660	728	794	859	926	972	1.038	1.104	1.172	1.237	1.303	1.370
3,60	432	504	551	621	691	760	831	900	971	1.019	1.088	1.158	1.227	1.298	1.367	1.438
3,80	451	523	574	646	721	795	868	941	1.015	1.064	1.139	1.212	1.285	1.357	1.432	1.505
4,00	468	545	597	674	751	829	906	982	1.059	1.111	1.188	1.265	1.341	1.418	1.495	1.572

Medidas en m.



Cortina vertical 127

034202

Sax 3000 • Shantung • Calipso

Precio € ud

Alto	Ancho															
	1,00	1,20	1,40	1,60	1,80	2,00	2,20	2,40	2,60	2,80	3,00	3,20	3,40	3,60	3,80	4,00
1,00	136	144	154	163	173	181	187	197	206	215	224	232	243	251	260	269
1,20	139	150	159	169	178	189	194	205	214	224	235	244	253	263	273	283
1,40	141	153	163	175	185	194	201	213	222	232	244	254	265	275	286	294
1,60	147	156	168	179	191	201	209	219	231	243	253	265	275	288	298	308
1,80	150	161	174	186	197	209	215	228	239	252	263	275	288	298	311	323
2,00	153	166	177	191	204	215	224	236	248	260	274	286	298	311	323	336
2,20	155	169	182	197	209	222	230	244	255	269	283	296	308	323	336	348
2,40	160	174	187	201	215	229	237	251	266	278	292	306	320	334	348	362
2,60	162	177	192	207	220	236	244	258	274	289	302	316	331	345	361	375
2,80	167	181	197	213	228	243	252	267	282	296	313	328	343	357	371	389
3,00	169	186	201	217	232	250	258	275	290	306	323	339	353	369	386	401
3,20	174	190	206	224	239	255	266	282	299	315	331	348	365	382	399	414
3,40	176	193	212	229	245	263	273	290	307	325	342	359	376	392	409	428
3,60	179	198	215	235	252	269	279	298	315	332	352	369	388	405	422	442
3,80	182	201	220	239	256	276	288	306	324	343	362	381	399	417	437	453
4,00	187	206	225	245	265	283	293	313	332	352	370	390	408	429	447	467

Black-Out • Shantung-M1 • Berlin Black-Out

Precio € ud

Alto	Ancho															
	1,00	1,20	1,40	1,60	1,80	2,00	2,20	2,40	2,60	2,80	3,00	3,20	3,40	3,60	3,80	4,00
1,00	148	160	171	182	193	206	213	225	236	248	258	270	282	293	305	316
1,20	154	167	178	192	205	217	225	238	251	263	276	289	302	314	327	340
1,40	160	174	187	201	215	229	237	252	266	278	292	307	321	334	348	363
1,60	166	179	194	212	227	240	250	266	279	294	311	325	340	354	369	384
1,80	173	189	204	219	236	252	262	277	293	311	327	343	359	375	391	407
2,00	177	194	212	229	247	265	274	291	308	327	344	362	378	394	413	430
2,20	182	201	220	238	256	276	286	305	324	343	361	380	399	415	434	453
2,40	189	209	229	248	268	288	299	317	339	357	378	397	417	437	457	476
2,60	194	215	237	256	277	299	312	331	352	374	393	415	437	457	478	498
2,80	200	222	245	267	289	311	324	345	367	389	412	432	455	477	500	521
3,00	206	229	253	276	299	323	336	359	382	405	428	451	475	497	521	544
3,20	213	237	262	286	311	334	348	371	397	421	445	469	495	519	542	566
3,40	217	244	269	293	320	345	361	386	409	437	462	488	514	539	564	589
3,60	224	251	277	304	330	357	371	399	426	452	480	505	532	559	584	612
3,80	230	256	286	313	342	368	384	412	440	467	496	523	551	580	606	635
4,00	236	265	293	323	352	381	397	426	455	483	511	542	569	599	628	658

Sax Screen 3600 1% 5%

Precio € ud

Alto	Ancho															
	1,00	1,20	1,40	1,60	1,80	2,00	2,20	2,40	2,60	2,80	3,00	3,20	3,40	3,60	3,80	4,00
1,00	156	171	185	198	212	225	232	247	260	274	288	301	314	327	340	353
1,20	166	179	194	210	225	239	250	265	278	293	308	324	339	353	368	384
1,40	174	190	206	222	239	255	266	282	298	315	331	348	365	381	399	414
1,60	179	199	216	235	253	270	282	299	317	336	353	371	390	407	427	444
1,80	189	209	228	248	267	288	298	316	337	355	376	394	415	434	455	475
2,00	197	216	238	260	279	302	314	334	355	378	399	420	442	462	483	504
2,20	205	227	250	273	294	316	330	353	375	399	421	444	466	489	511	535
2,40	212	236	260	285	308	332	346	370	394	420	443	467	491	516	541	565
2,60	219	245	270	296	323	348	363	389	414	440	466	491	518	543	568	595
2,80	228	254	282	308	336	365	380	406	432	460	488	516	543	569	597	623
3,00	235	265	292	321	351	380	394	424	452	482	509	539	568	597	624	656
3,20	243	274	304	332	365	393	412	442	472	503	534	564	593	623	654	684
3,40	251	282	314	346	378	409	428	459	491	522	555	587	619	652	682	715
3,60	256	291	325	359	391	426	444	477	509	544	578	611	644	679	712	745
3,80	266	301	336	370	406	442	460	495	529	565	599	635	670	705	741	775
4,00	274	311	346	383	420	457	477	514	549	585	622	659	696	733	769	806



Cortina vertical 127

034202

Screen 8505 • Altea • Darktex Black-Out • Cosmos • Screen Artemis 1% 3% 5%

Precio € ud

Alto	Ancho															
	1,00	1,20	1,40	1,60	1,80	2,00	2,20	2,40	2,60	2,80	3,00	3,20	3,40	3,60	3,80	4,00
1,00	178	197	214	231	250	267	277	294	313	330	348	366	383	401	419	437
1,20	191	210	230	251	270	291	302	323	343	362	382	403	422	443	462	482
1,40	201	225	248	269	292	314	328	350	371	393	417	439	462	483	506	528
1,60	214	239	265	289	313	339	352	376	403	427	451	477	501	526	549	576
1,80	227	253	279	307	334	362	376	405	431	459	485	514	541	567	595	621
2,00	238	268	296	327	355	386	403	431	462	490	520	549	580	610	639	668
2,20	251	282	314	345	378	409	427	459	491	522	555	585	619	652	682	715
2,40	262	296	330	365	400	432	452	485	521	555	589	623	658	692	728	760
2,60	274	311	346	384	421	458	477	515	551	587	623	660	697	734	771	807
2,80	286	325	365	404	442	481	503	542	581	619	658	697	736	775	814	854
3,00	298	339	381	422	463	505	527	568	611	652	693	734	775	818	858	900
3,20	311	353	397	442	484	529	553	596	641	683	728	772	814	859	903	946
3,40	321	368	414	460	506	553	577	622	670	716	761	808	854	900	946	994
3,60	332	382	430	480	528	577	603	652	699	749	796	845	894	943	990	1.040
3,80	345	397	446	498	549	599	627	679	730	780	831	883	933	984	1.036	1.086
4,00	357	409	465	518	572	623	653	705	759	812	865	920	972	1.026	1.079	1.134

Brasilia • Cosmos Perla

Precio € ud

Alto	Ancho															
	1,00	1,20	1,40	1,60	1,80	2,00	2,20	2,40	2,60	2,80	3,00	3,20	3,40	3,60	3,80	4,00
1,00	197	217	239	262	282	304	315	337	357	380	401	422	443	465	485	506
1,20	213	237	262	286	311	334	348	371	397	421	445	469	495	519	543	567
1,40	228	255	283	311	339	366	381	408	437	463	490	519	545	573	601	628
1,60	244	274	305	336	366	397	413	444	476	505	536	566	597	628	658	690
1,80	258	292	327	361	393	428	446	480	514	546	581	615	649	682	716	750
2,00	275	312	348	386	422	459	480	516	553	589	627	662	699	736	773	811
2,20	290	330	369	409	450	490	511	551	592	631	672	711	751	791	831	871
2,40	306	350	391	434	478	521	544	587	631	673	716	759	804	846	889	932
2,60	321	367	414	460	506	553	577	622	669	715	761	808	854	900	946	991
2,80	337	386	437	484	535	583	610	659	708	758	807	856	906	953	1.004	1.052
3,00	352	405	458	509	561	615	642	695	748	799	851	905	957	1.009	1.061	1.114
3,20	368	424	480	535	591	645	675	731	787	843	897	952	1.009	1.064	1.120	1.175
3,40	383	443	501	559	619	677	708	767	825	884	943	1.001	1.060	1.118	1.176	1.236
3,60	400	460	522	584	645	708	741	800	864	926	987	1.049	1.111	1.173	1.235	1.295
3,80	414	480	544	610	674	738	773	837	903	968	1.033	1.098	1.163	1.226	1.291	1.356
4,00	430	498	566	635	703	771	806	873	943	1.010	1.078	1.145	1.213	1.281	1.350	1.417

Medidas en m.



Cortina vertical 250

034200

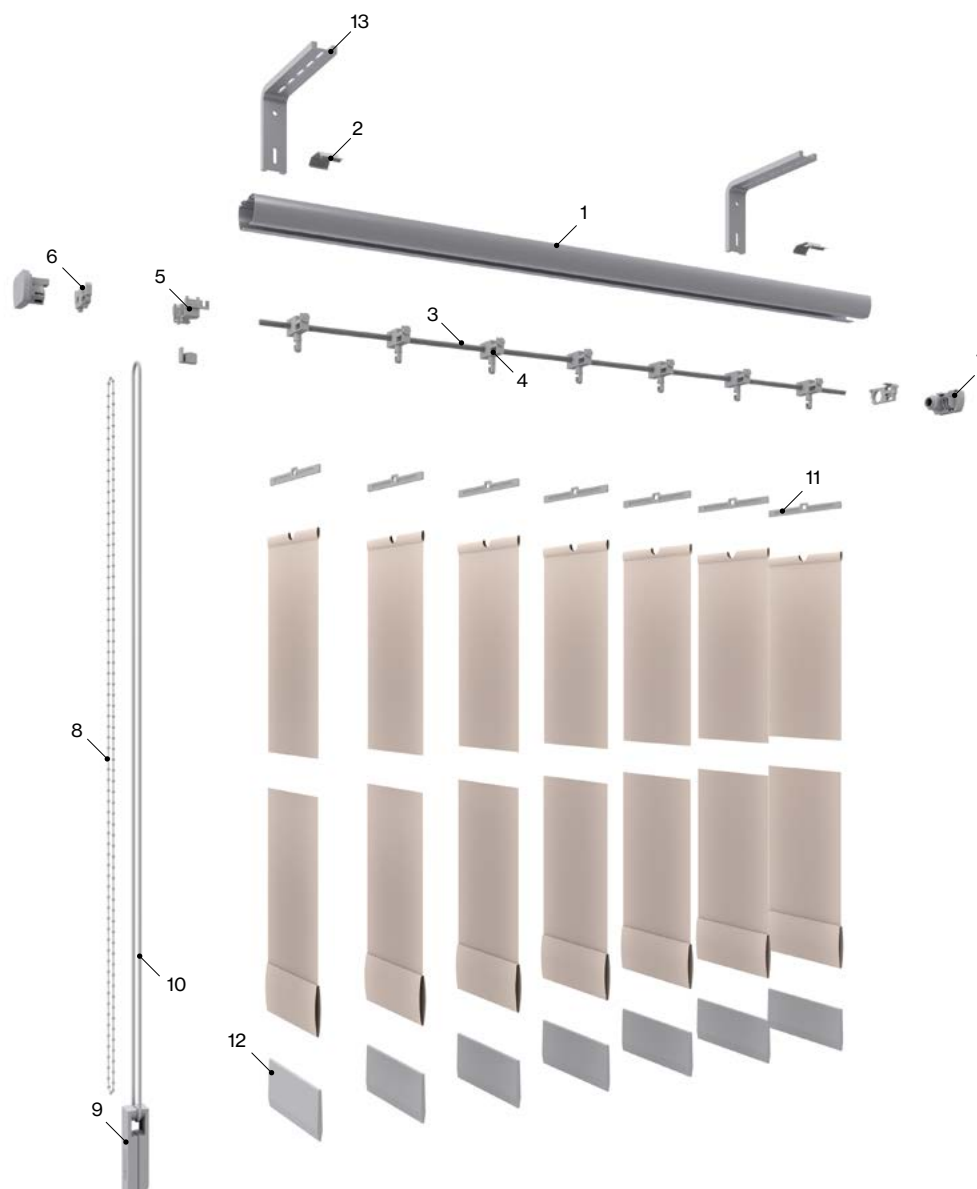

Componentes

Nº	Cód.	Descripción	Nº	Cód.	Descripción
1	034267	Riel vertical redondo CLS	8	030483	Cadena mando 3,8x9 mm
2	034222	Soporte riel vertical	9	030426	Tensor slim XL
3	029159	Eje 3 vías	10	034022	Cordón
4	034221	Carro 3 vías gancho CLS	11	030151	Percha plástico 250
5	034217	Carro arrastre CLS	12	030153	Contrapeso 250
6	034279	Ventana de cristal laminado 180x300 mm	13	034052	Escuadra 21 cm
7	034224	Tapadera lado contrario CLS			

Medidas de fabricación

Máximos		Mínimos	
Ancho	5,80 m	Ancho	0,25 m
Alto	4,00 m	Alto	0,27 m

Cortina vertical 250

034200

Sax 3000 • Shantung • Deimos • Calipso

Precio € ud

Alto	Ancho															
	1,00	1,20	1,40	1,60	1,80	2,00	2,20	2,40	2,60	2,80	3,00	3,20	3,40	3,60	3,80	4,00
1,00	148	161	174	187	199	213	225	237	251	263	276	289	302	314	328	340
1,20	153	167	181	194	209	222	236	250	265	277	291	305	320	332	346	361
1,40	159	174	189	204	217	232	247	262	276	291	306	321	336	351	366	381
1,60	163	178	194	212	228	243	258	274	290	306	323	337	353	369	386	401
1,80	168	186	201	219	236	253	269	286	304	320	337	353	370	388	405	421
2,00	174	191	210	228	245	263	279	298	316	334	352	369	389	406	424	442
2,20	178	198	216	236	254	274	291	311	329	348	367	386	405	424	443	462
2,40	185	204	224	244	265	283	304	323	343	363	383	403	422	443	463	482
2,60	189	210	230	252	273	293	314	334	355	376	399	419	440	460	482	503
2,80	193	215	238	260	282	304	325	346	369	391	413	434	458	480	501	522
3,00	199	222	245	268	291	314	336	359	382	405	428	451	475	497	520	543
3,20	205	228	252	276	301	324	348	370	394	420	444	467	491	516	541	564
3,40	209	235	258	285	308	334	359	383	408	432	459	483	508	534	559	583
3,60	214	239	267	292	317	344	369	394	422	447	475	500	527	553	578	604
3,80	219	247	274	301	328	354	381	407	434	462	489	516	543	569	597	623
4,00	225	252	279	308	337	365	392	420	447	477	505	532	560	589	618	644

Mimo • Shantung M1 • Fobos • Leda Black-Out • Herse Black-Out • Arce

Precio € ud

Alto	Ancho															
	1,00	1,20	1,40	1,60	1,80	2,00	2,20	2,40	2,60	2,80	3,00	3,20	3,40	3,60	3,80	4,00
1,00	159	174	189	204	217	232	247	262	276	291	306	321	336	351	366	381
1,20	166	181	198	214	230	247	263	278	294	312	328	344	361	376	392	408
1,40	173	190	209	227	244	262	277	296	314	331	350	367	384	403	420	438
1,60	179	199	217	237	255	275	293	313	331	351	370	390	408	428	446	466
1,80	187	207	228	248	269	290	311	330	351	370	391	413	432	453	475	495
2,00	193	215	238	260	282	304	325	346	369	391	413	434	458	480	501	522
2,20	200	225	248	270	294	317	342	365	388	412	434	458	481	505	528	551
2,40	209	232	256	283	307	331	355	382	406	430	457	481	505	530	555	580
2,60	215	240	268	293	320	346	371	399	426	451	477	504	529	557	582	607
2,80	222	251	277	305	332	361	388	415	443	470	498	527	554	581	610	636
3,00	229	258	288	316	345	375	404	431	462	490	520	547	578	606	636	665
3,20	237	267	298	328	359	389	419	450	480	509	542	572	603	633	662	693
3,40	244	275	307	340	370	404	434	467	498	530	561	595	627	658	691	721
3,60	251	285	316	351	384	417	450	483	518	549	583	618	650	683	718	750
3,80	256	292	328	362	397	431	466	501	535	569	605	641	674	710	745	779
4,00	266	301	337	374	409	445	482	518	554	591	627	661	698	735	772	807

Black-Out • Berlín • Bamboo • Ariel • Jano • Azur • Letho • Cosmo • Altea • Casablanca

Precio € ud

Alto	Ancho															
	1,00	1,20	1,40	1,60	1,80	2,00	2,20	2,40	2,60	2,80	3,00	3,20	3,40	3,60	3,80	4,00
1,00	166	181	198	214	230	247	262	277	293	311	327	343	359	375	391	407
1,20	174	191	210	228	245	263	279	298	316	334	352	369	389	406	424	442
1,40	181	201	220	240	260	279	299	317	339	357	378	397	417	437	457	476
1,60	191	212	232	254	276	296	317	339	361	382	404	424	445	467	489	508
1,80	199	222	245	268	291	314	336	359	382	405	428	451	475	497	520	543
2,00	207	231	256	282	306	330	354	380	405	429	453	478	504	528	553	577
2,20	215	243	268	294	321	348	374	400	427	452	480	505	532	558	584	611
2,40	225	252	279	308	337	365	392	420	447	477	505	532	560	589	618	644
2,60	232	263	292	323	352	382	409	440	469	500	529	559	589	619	649	679
2,80	240	273	305	336	367	399	429	460	492	523	555	585	619	650	681	712
3,00	250	283	315	350	382	415	447	481	515	546	581	614	646	680	713	746
3,20	258	292	328	363	399	431	467	501	536	572	606	641	675	711	746	780
3,40	267	304	340	376	413	450	484	521	558	595	631	668	704	741	776	813
3,60	275	313	352	390	428	466	504	542	581	619	657	695	734	772	810	848
3,80	283	324	363	404	443	483	522	561	603	642	682	721	761	800	843	882
4,00	292	332	375	417	459	500	542	582	623	666	708	749	791	833	874	914



Cortina vertical 250

034200

Sax Screen 3600 1% 5% 10%

Precio € ud																
Alto	Ancho															
	1,00	1,20	1,40	1,60	1,80	2,00	2,20	2,40	2,60	2,80	3,00	3,20	3,40	3,60	3,80	4,00
1,00	174	190	207	224	239	255	273	289	306	323	339	354	371	389	405	421
1,20	182	200	219	237	255	274	291	311	328	346	366	383	403	420	439	457
1,40	191	212	231	252	270	291	312	331	351	370	391	412	431	452	472	491
1,60	200	222	244	266	288	308	330	352	374	394	419	440	462	483	505	527
1,80	209	232	255	278	304	327	350	374	397	421	444	468	491	515	539	561
2,00	217	243	268	293	320	344	369	393	420	445	470	496	521	546	573	597
2,20	227	253	279	307	334	362	389	415	443	469	497	523	551	578	605	633
2,40	236	265	292	323	351	380	407	438	466	495	523	553	581	611	639	668
2,60	244	275	305	336	367	397	427	458	489	519	549	581	611	642	673	703
2,80	253	286	316	350	382	414	446	480	511	544	577	610	642	673	705	737
3,00	262	294	330	365	399	431	466	500	535	568	603	636	672	705	738	773
3,20	270	306	343	378	414	450	484	521	557	593	630	665	700	736	773	808
3,40	278	316	354	392	429	467	505	543	580	618	656	693	731	769	807	844
3,60	289	328	367	406	445	484	523	564	603	642	682	721	760	799	838	877
3,80	296	339	380	420	462	503	543	584	624	668	708	750	791	831	873	913
4,00	306	348	391	434	478	520	564	605	649	692	735	776	820	864	907	949

Sax Screen 5500 1% 3% 5% 10% • Screen Artemis 1% 3% 5% • Sax Screen Dione

Precio € ud																
Alto	Ancho															
	1,00	1,20	1,40	1,60	1,80	2,00	2,20	2,40	2,60	2,80	3,00	3,20	3,40	3,60	3,80	4,00
1,00	179	198	216	235	252	269	288	305	324	342	359	376	394	413	430	447
1,20	191	210	230	251	270	290	311	329	350	369	390	408	429	450	469	489
1,40	200	222	245	267	289	311	331	353	376	399	420	442	465	485	507	529
1,60	212	235	258	283	307	330	354	378	403	427	451	475	498	522	546	569
1,80	220	247	274	299	325	351	376	403	429	455	481	506	534	559	584	611
2,00	231	258	288	315	344	370	400	427	455	483	511	539	567	596	623	652
2,20	240	270	302	331	362	391	421	451	482	511	542	572	603	633	661	692
2,40	252	283	315	348	381	412	444	476	507	541	573	604	636	669	700	733
2,60	262	294	330	365	399	431	466	500	535	568	603	636	672	705	738	773
2,80	273	307	344	381	417	452	489	523	560	597	634	669	705	742	779	813
3,00	282	320	359	397	434	472	509	547	587	624	662	700	741	779	817	854
3,20	292	331	371	413	453	492	534	573	614	654	695	734	774	814	856	895
3,40	302	344	388	429	470	514	555	597	641	682	723	767	810	851	894	935
3,60	313	355	401	445	490	534	578	621	666	711	756	798	844	888	933	975
3,80	323	368	415	462	507	554	599	645	693	738	785	831	877	925	971	1.017
4,00	332	381	429	478	527	574	622	670	719	768	817	864	912	961	1.010	1.058

Darktex Black-Out

Precio € ud																
Alto	Ancho															
	1,00	1,20	1,40	1,60	1,80	2,00	2,20	2,40	2,60	2,80	3,00	3,20	3,40	3,60	3,80	4,00
1,00	189	209	228	248	267	288	306	325	345	365	384	404	424	443	463	482
1,20	200	222	245	267	289	311	331	353	376	399	420	442	465	485	507	529
1,40	213	237	262	286	311	334	357	382	406	430	455	480	504	528	553	577
1,60	225	251	277	305	331	357	384	409	438	465	491	518	544	572	598	623
1,80	236	266	293	324	352	382	409	439	468	497	527	555	584	614	643	672
2,00	248	278	312	343	374	405	437	467	500	530	561	593	624	657	688	719
2,20	260	293	328	362	394	429	462	496	529	564	597	631	665	698	733	767
2,40	273	307	344	381	417	452	489	523	560	597	634	669	705	742	779	813
2,60	283	323	361	400	438	477	515	553	592	630	669	707	746	784	823	861
2,80	294	336	378	419	459	500	541	581	622	662	704	745	787	827	868	909
3,00	307	351	393	438	481	523	566	610	653	696	738	782	826	869	912	956
3,20	320	365	409	457	503	546	593	637	683	730	775	820	867	912	959	1.003
3,40	330	380	427	476	522	572	619	666	715	761	811	858	907	953	1.003	1.050
3,60	343	392	444	495	544	595	644	695	746	796	846	896	948	998	1.048	1.098
3,80	354	407	460	514	566	619	670	722	775	829	882	934	987	1.040	1.091	1.145
4,00	367	421	477	532	587	642	697	751	807	863	918	972	1.027	1.083	1.139	1.193

Cortina vertical 250

034200

Screen 8505 • Screen 2165 • Soltis Lounge 96 • Soltis 99

Precio € ud

Alto	Ancho															
	1,00	1,20	1,40	1,60	1,80	2,00	2,20	2,40	2,60	2,80	3,00	3,20	3,40	3,60	3,80	4,00
1,00	216	240	267	291	316	342	366	391	415	442	467	491	518	542	567	592
1,20	232	262	291	320	348	376	405	432	462	490	519	546	576	604	633	661
1,40	251	283	315	346	380	412	443	475	506	539	569	603	635	666	698	731
1,60	268	304	339	375	409	445	481	516	551	587	622	658	693	730	766	799
1,80	286	325	363	403	442	481	519	558	597	635	674	713	753	792	830	869
2,00	304	345	388	430	472	515	557	599	642	683	728	769	811	854	896	938
2,20	320	366	412	458	504	549	595	641	685	733	779	825	871	915	963	1.009
2,40	337	388	437	485	535	584	633	682	731	781	830	881	928	979	1.027	1.078
2,60	354	407	460	514	566	619	672	723	776	830	883	935	988	1.041	1.095	1.147
2,80	371	428	484	542	597	654	710	766	821	877	934	990	1.047	1.103	1.160	1.216
3,00	390	450	508	568	628	688	748	807	867	926	987	1.047	1.105	1.165	1.225	1.285
3,20	406	469	534	597	659	722	785	849	912	974	1.038	1.102	1.164	1.227	1.291	1.355
3,40	424	490	558	623	691	758	823	890	957	1.024	1.089	1.158	1.224	1.290	1.357	1.425
3,60	442	511	582	652	721	792	861	932	1.002	1.072	1.142	1.213	1.281	1.352	1.424	1.493
3,80	459	532	606	680	753	827	900	973	1.047	1.121	1.194	1.268	1.341	1.415	1.489	1.563
4,00	477	554	630	707	784	861	938	1.015	1.091	1.168	1.247	1.324	1.401	1.477	1.554	1.631

Soltis Horizon 86 • Hispa • Anae • Stella

Precio € ud

Alto	Ancho															
	1,00	1,20	1,40	1,60	1,80	2,00	2,20	2,40	2,60	2,80	3,00	3,20	3,40	3,60	3,80	4,00
1,00	227	253	282	308	336	363	389	417	444	470	498	526	553	580	606	634
1,20	247	277	308	340	370	403	431	463	495	526	557	587	619	650	681	712
1,40	266	301	336	370	405	440	476	508	544	580	615	650	684	720	754	789
1,60	285	324	363	403	440	480	518	557	596	634	673	712	750	789	829	868
1,80	305	346	390	431	476	519	560	603	645	688	731	774	817	859	902	945
2,00	324	370	417	463	509	557	603	650	696	743	789	836	883	928	975	1.022
2,20	343	393	444	495	545	596	645	696	746	797	848	897	949	999	1.049	1.101
2,40	363	417	470	526	581	635	688	743	797	851	906	960	1.015	1.070	1.124	1.178
2,60	382	440	498	557	615	673	731	789	848	906	964	1.022	1.080	1.139	1.198	1.256
2,80	401	463	526	587	650	712	774	835	897	960	1.022	1.084	1.147	1.210	1.272	1.333
3,00	421	488	553	619	684	751	817	883	949	1.015	1.080	1.147	1.213	1.279	1.346	1.411
3,20	440	509	581	650	720	791	859	928	999	1.070	1.139	1.210	1.279	1.349	1.418	1.489
3,40	460	534	607	681	756	829	902	975	1.049	1.124	1.197	1.272	1.346	1.418	1.493	1.566
3,60	480	557	635	712	791	868	945	1.022	1.101	1.178	1.256	1.333	1.411	1.489	1.566	1.645
3,80	498	580	661	743	825	907	987	1.070	1.151	1.232	1.314	1.395	1.477	1.558	1.641	1.722
4,00	519	604	690	774	859	945	1.029	1.116	1.201	1.287	1.373	1.457	1.543	1.628	1.715	1.799

Soltis Perform 92 • Soltis Proof W96

Precio € ud

Alto	Ancho															
	1,00	1,20	1,40	1,60	1,80	2,00	2,20	2,40	2,60	2,80	3,00	3,20	3,40	3,60	3,80	4,00
1,00	267	302	339	374	408	444	478	515	549	584	620	656	691	726	760	796
1,20	294	336	376	417	458	500	539	580	621	661	703	743	784	825	867	907
1,40	323	368	415	462	507	554	599	645	692	738	785	831	876	925	971	1.017
1,60	350	403	453	505	558	610	660	712	762	817	868	920	972	1.024	1.075	1.127
1,80	378	434	491	549	606	665	720	779	835	894	950	1.007	1.065	1.122	1.180	1.237
2,00	405	468	530	593	657	719	781	845	907	971	1.033	1.097	1.159	1.221	1.285	1.348
2,20	431	501	568	637	707	774	843	911	979	1.048	1.116	1.185	1.252	1.320	1.389	1.457
2,40	460	534	607	682	756	830	903	975	1.050	1.125	1.198	1.273	1.346	1.419	1.494	1.567
2,60	488	567	645	726	806	884	964	1.042	1.122	1.202	1.280	1.360	1.440	1.519	1.599	1.679
2,80	515	599	684	771	854	940	1.024	1.109	1.194	1.279	1.363	1.449	1.533	1.619	1.703	1.787
3,00	543	634	722	813	905	995	1.084	1.175	1.265	1.356	1.446	1.535	1.627	1.718	1.809	1.898
3,20	569	666	761	858	953	1.050	1.145	1.241	1.337	1.433	1.528	1.624	1.720	1.817	1.912	2.009
3,40	598	698	799	902	1.003	1.104	1.205	1.308	1.409	1.510	1.610	1.712	1.814	1.915	2.016	2.119
3,60	624	733	838	946	1.052	1.160	1.265	1.373	1.480	1.586	1.695	1.801	1.909	2.015	2.123	2.229
3,80	653	766	876	989	1.103	1.216	1.327	1.439	1.551	1.664	1.778	1.889	2.002	2.114	2.226	2.339
4,00	681	798	915	1.034	1.152	1.270	1.388	1.505	1.623	1.741	1.860	1.977	2.095	2.213	2.331	2.450



Cortina vertical 250

034200

Soltis Opaque B92 • Screen Elarus Black-Out

Precio € ud

Alto	Ancho															
	1,00	1,20	1,40	1,60	1,80	2,00	2,20	2,40	2,60	2,80	3,00	3,20	3,40	3,60	3,80	4,00
1,00	315	361	406	451	496	541	584	630	675	720	766	810	856	900	945	989
1,20	353	405	458	509	564	615	668	719	772	825	876	928	982	1.034	1.087	1.139
1,40	390	450	509	569	630	690	749	808	869	928	988	1.048	1.109	1.167	1.227	1.288
1,60	428	495	561	630	697	762	831	897	965	1.033	1.101	1.166	1.235	1.302	1.370	1.436
1,80	465	539	615	690	762	837	912	987	1.063	1.137	1.212	1.287	1.362	1.436	1.510	1.585
2,00	503	583	666	749	831	912	995	1.076	1.159	1.241	1.324	1.405	1.488	1.570	1.653	1.734
2,20	539	628	719	808	897	987	1.076	1.165	1.256	1.346	1.434	1.525	1.616	1.704	1.794	1.883
2,40	577	673	771	868	965	1.061	1.159	1.255	1.352	1.450	1.547	1.643	1.741	1.838	1.935	2.032
2,60	614	718	823	927	1.032	1.136	1.240	1.344	1.450	1.554	1.658	1.762	1.869	1.972	2.076	2.180
2,80	652	761	874	987	1.099	1.211	1.323	1.433	1.546	1.658	1.771	1.881	1.994	2.107	2.218	2.329
3,00	688	807	927	1.047	1.165	1.285	1.404	1.523	1.643	1.762	1.881	2.000	2.122	2.240	2.360	2.478
3,20	726	851	979	1.105	1.234	1.358	1.487	1.611	1.740	1.868	1.994	2.121	2.247	2.375	2.501	2.628
3,40	761	896	1.032	1.165	1.300	1.433	1.567	1.702	1.837	1.971	2.105	2.239	2.375	2.508	2.643	2.777
3,60	799	941	1.083	1.225	1.367	1.508	1.649	1.792	1.933	2.075	2.217	2.358	2.500	2.643	2.784	2.924
3,80	836	986	1.136	1.285	1.433	1.582	1.732	1.880	2.031	2.179	2.328	2.477	2.628	2.777	2.924	3.074
4,00	874	1.029	1.187	1.344	1.502	1.657	1.814	1.970	2.126	2.284	2.440	2.596	2.753	2.911	3.068	3.223

Brasilia • Jávea • Screen Nimbus • Screen Kore • Cosmos Perla • Umbriel

Precio € ud

Alto	Ancho															
	1,00	1,20	1,40	1,60	1,80	2,00	2,20	2,40	2,60	2,80	3,00	3,20	3,40	3,60	3,80	4,00
1,00	214	238	265	289	313	337	362	386	412	437	460	484	509	535	559	583
1,20	231	258	288	315	344	370	400	427	455	483	511	539	567	596	623	652
1,40	248	278	312	343	374	405	437	467	500	530	561	593	624	657	688	719
1,60	266	299	334	369	405	439	475	507	543	578	614	646	682	718	753	787
1,80	282	320	359	397	434	472	509	547	587	624	662	700	741	779	817	854
2,00	299	340	382	424	466	506	547	589	631	673	715	756	797	838	882	922
2,20	315	361	406	451	496	541	584	630	675	720	766	810	856	900	945	989
2,40	332	381	429	478	527	574	622	670	719	768	817	864	912	961	1.010	1.058
2,60	350	401	453	505	557	607	659	711	762	814	867	918	971	1.022	1.074	1.125
2,80	367	421	477	532	587	642	697	751	807	863	918	972	1.027	1.083	1.139	1.193
3,00	383	442	501	559	618	675	734	792	851	910	968	1.026	1.086	1.143	1.202	1.260
3,20	401	462	523	585	649	710	772	833	895	957	1.020	1.080	1.142	1.204	1.267	1.328
3,40	417	482	547	614	679	743	808	873	940	1.004	1.070	1.135	1.201	1.265	1.331	1.395
3,60	434	503	572	641	710	776	846	913	983	1.051	1.121	1.188	1.257	1.327	1.395	1.464
3,80	451	522	596	668	738	811	883	953	1.027	1.099	1.172	1.242	1.316	1.388	1.458	1.531
4,00	468	543	619	695	771	845	921	995	1.071	1.147	1.222	1.297	1.373	1.449	1.525	1.599

Medidas en m.



Cortina vertical 89 • 127 • 250

Cabezal completo

	89 mm € ml	127 mm € ml	250 mm € ml
	034290	034291	034292
Blanco	67,00	63,00	60,00
Negro	73,00	69,00	65,00
Plata	70,00	67,00	62,00

• Mínimo a facturar 1 ml.

Lamas confeccionadas

	89 mm € ml	127 mm € ml	250 mm € ml
	034050	034051	034075
Sax 3000	1,50	1,85	5,18
Shantung	1,50	1,85	5,18
Deimos	-	-	5,18
Calipso	1,50	1,85	5,18
Mimo	-	-	7,00
Shantung-M1	2,19	3,25	7,00
Fobos	-	-	7,00
Black-Out	2,19	3,25	7,00
Berlín Black-Out	2,19	3,25	7,00
Bamboo	-	-	7,00
Ariel	-	-	7,00
Jano	-	-	7,00
Azur	-	-	7,00
Letho	-	-	7,00
Cosmos	4,95	7,30	7,00
Altea	5,18	6,35	7,00
Casablanca	-	-	11,00
Sax Screen 3600 1%	4,25	6,10	9,00
Sax Screen 3600 5%	3,65	5,18	9,00
Sax Screen 3600 10%	-	-	9,00
Sax Screen 5500 1% 3% 5% 10%	-	-	11,00
Screen Artemis 1%	5,52	8,30	11,00
Screen Artemis 3%	5,18	7,50	11,00
Screen Artemis 5%	4,95	7,24	11,00
Darktex Black-Out	4,14	6,80	11,00
Screen 8505	4,95	7,30	12,00
Screen 2165	-	-	12,00
Soltis Lounge 96	-	-	12,00
Soltis 99	-	-	12,00
Soltis Horizon 86	-	-	15,00
Hispa	-	-	15,00
Anae	-	-	15,00
Stella	-	-	15,00
Soltis Perform 92	-	-	20,00
Soltis Proof W96	-	-	20,00
Soltis Opaque B92	-	-	40,00
Screen Elarus Black-Out	-	-	40,00
Brasilia	7,60	9,85	12,00
Jávea	-	-	12,00
Nimbus	-	-	12,00
Kore	-	-	12,00
Cosmos Perla	7,60	9,85	12,00
Leda Black-Out	-	-	7,00
Herse Black-Out	-	-	7,00
Arce	-	-	7,00
Sax Screen Dione	-	-	11,00

• En caso de no indicarse los accesorios se servirán en blanco. Si deseas otra combinación ha de solicitarse en el pedido.

• Mínimo a facturar 1 ml.

• Motorización **ver tarifa de Motores y Automatismos.** ⚙️



Cortina vertical

Incremento • Sistema Cortina vertical

	Precio € ud • Cortina confeccionada
Inclinada. Cabezal <i>Accesorios sólo en blanco y gris. No se fabrica motorizada. No disponible en lama 250</i>	46,00
Inclinada. Lamas en escalera	95,00
Inclinada. Cabezal horizontal	46,00
Curva <i>No se fabrica motorizada. No disponible en lama de 250.</i>	425,00
Accionamiento doble varilla	17,00
Accionamiento varilla	Sin incremento

Inclinada. Cabezal

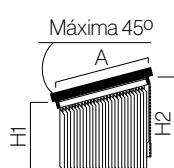

Inclinada. Lamas en escalera

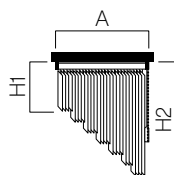

Inclinada. Cabeza horizontal

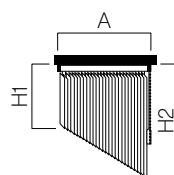

Curva

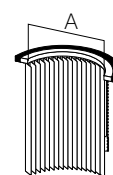

Incremento • Accesorios varios

Colores combinados (máximo 3) Lama de 89, 127 y 250	Precio € ud 33,00
--	-----------------------------

Incremento • Impresión digital

Tejidos impresión digital (mínimo 1,50 m ² , sólo para lama 250) Sobre el precio Sax 3000, Sax Screen 3600 1% 5% y Black-Out	Precio € m ² 65,00
--	---

Incremento • Accesorios

	Precio €
- Terminal slim (sólo lama 250)	2,50 ud
034048 Escuadra separación de 10 cm <i>Blanco, Gris, Negro, Marrón, Marfil</i>	5,00 ud
034049 Escuadra separación de 14 cm <i>Blanco, Gris, Negro, Marrón, Marfil</i>	5,50 ud
034052 Escuadra separación de 21 cm <i>Blanco, Gris, Negro</i>	6,00 ud

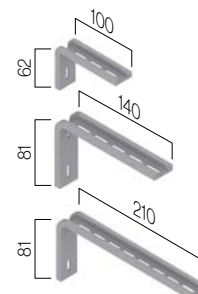



Cortina vertical

Configuraciones

Según la ubicación de los mandos

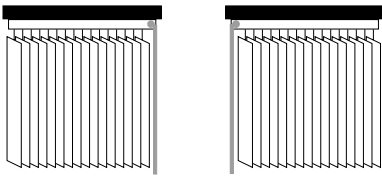

Derecha

Izquierda

Según la ubicación de los repliegues

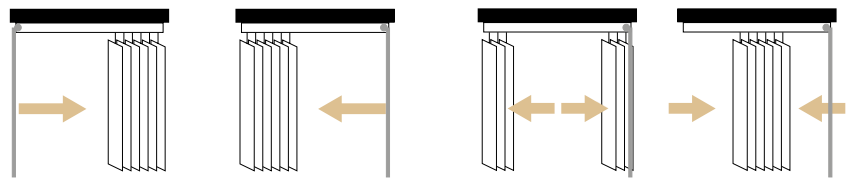

Derecha

Izquierda

Ambos lados

Al centro

• Colores disponibles de cadena distanciadora en blanco, gris y negro.

Hueco y repliegues • Fórmula para calcular la ocupación de lamas conociendo el ancho de la cortina

		Repliegue a un lado	Repliegue a ambos lados
Lama 89	0,15 x Medida del cabezal en cm.	+8 cm	+16 cm
Lama 127	0,105 x Medida del cabezal en cm.	+10 cm	+20 cm
Lama 250	0,10 x Medida del cabezal en cm.	+19,10 cm	+38,20 cm

Perfiles

Terminal slim



Medidas en mm.

Configuraciones

Snodos

	Corto	Medio	Largo	Extra largo
Lama 127	≤ 26°	≤ 35°	≤ 40°	≤ 50°
Lama 89	≤ 38°	≤ 45°	≤ 50°	-

• Sistema no disponible para la 250.

Panel deslizante

Haz clic o escanea
para acceder a la ficha
de prescripción





Modelos

Panel deslizante

030400 Sistema Básico

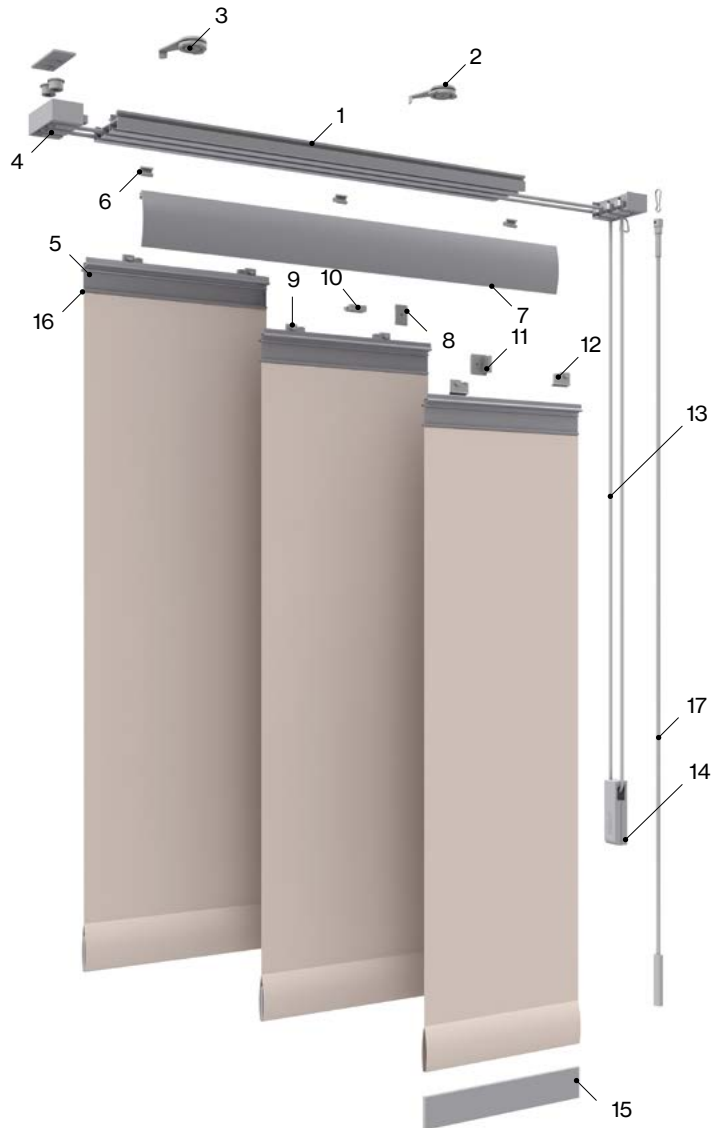

Componentes

Nº	Cód.	Descripción	Nº	Cód.	Descripción
1	030451	Perfil Panel deslizante - 3 vías	10	030707	Unión de cordón
2	030477	Soporte perfil 2 y 3 vías Panel deslizante	11	030711	Tope en "T"
3	030478	Soporte perfil 4 y 5 vías Panel d eslizante	12	030470	Correderas porta telas
4	030463	Juego cabezal - 3 vías	13	030473	Cordón
5	030461	Porta telas velcrado	14	030426	Tensor Slim XL
6	030472	Soporte enlace perfil galería	15	030456	Pletina aluminio
7	030479	Perfil embellecedor	16	030413	Velcro macho
8	030710	Tope en "L"	17	030066	Varilla tirador 1 m
9	030709	Tope con tornillo			

Medidas de fabricación

Máximos		Mínimos	
Ancho	6,00 m	Ancho	0,30 m
Alto	3,00 m	Alto	0,30 m



Panel deslizante

030400

Sax 3000 • Shantung • Deimos • Calipso

Precio € ud							
Alto	Ancho						
	0,50	0,60	0,70	0,80	0,90	1,00	1,10
1,00	40	45	49	53	58	62	66
1,20	43	47	53	58	62	66	71
1,40	46	52	55	61	66	72	76
1,60	49	54	60	64	71	76	81
1,80	51	58	62	70	75	81	86
2,00	53	60	66	72	78	85	92
2,20	55	62	70	76	83	91	98
2,40	59	64	74	79	89	95	102
2,60	60	68	76	84	92	100	108
2,80	62	71	78	89	97	104	113
3,00	64	74	83	91	100	110	117

Mimo • Fobos • Shantung M1 • Leda Black-Out •
Herse Black-Out • Arce • Tiore

Precio € ud							
Alto	Ancho						
	0,50	0,60	0,70	0,80	0,90	1,00	1,10
1,00	45	49	53	59	62	68	74
1,20	47	52	58	62	70	75	79
1,40	51	55	62	68	75	79	86
1,60	53	60	66	74	79	86	93
1,80	55	63	71	78	85	91	100
2,00	60	66	75	83	90	99	106
2,20	62	71	79	87	97	105	113
2,40	64	75	84	93	101	110	118
2,60	68	78	87	98	108	116	127
2,80	72	81	91	102	113	123	133
3,00	75	85	97	108	117	129	139

Black-Out • Bamboo • Ariel • Jano • Berlín Black-Out • Azur •
Letho • Cosmos • Atlas • Casablanca • Tebe • Altea

Precio € ud							
Alto	Ancho						
	0,50	0,60	0,70	0,80	0,90	1,00	1,10
1,00	47	53	59	63	70	76	81
1,20	52	59	63	71	76	83	90
1,40	55	62	70	76	83	91	98
1,60	60	66	75	83	90	98	105
1,80	62	72	79	89	97	105	114
2,00	66	76	85	93	102	113	122
2,20	71	79	90	100	110	121	130
2,40	75	84	95	105	116	128	138
2,60	77	90	100	113	123	136	147
2,80	81	93	105	117	130	141	154
3,00	85	98	112	123	137	151	162

Sax Screen 3600 1% 5% 10%

Precio € ud							
Alto	Ancho						
	0,50	0,60	0,70	0,80	0,90	1,00	1,10
1,00	52	58	63	70	76	83	89
1,20	55	62	70	77	84	91	98
1,40	60	68	76	84	92	100	108
1,60	64	74	83	91	100	109	117
1,80	70	78	89	98	108	117	128
2,00	74	84	95	104	115	127	137
2,20	77	90	100	113	123	136	147
2,40	83	95	108	118	131	143	155
2,60	86	100	113	127	139	153	166
2,80	91	104	118	133	148	161	175
3,00	95	110	124	139	154	171	186

Sax Screen 5500 1% 3% 5% 10%
Screen Artemis 1% 3% 5% • Screen Dione

Precio € ud							
Alto	Ancho						
	0,50	0,60	0,70	0,80	0,90	1,00	1,10
1,00	58	63	71	77	85	92	99
1,20	62	71	78	86	95	102	112
1,40	68	76	85	95	104	114	123
1,60	74	83	93	104	114	124	136
1,80	78	90	101	113	124	136	148
2,00	84	97	109	121	135	147	159
2,20	90	102	116	130	143	156	171
2,40	95	109	123	138	153	168	182
2,60	100	115	131	148	162	178	194
2,80	105	122	139	155	174	190	207
3,00	112	129	147	163	182	200	217

Screen 8505 • Screen 2165 • Soltis 99 • Screen Titan
Soltis Harmony 88 • Umbriel

Precio € ud							
Alto	Ancho						
	0,50	0,60	0,70	0,80	0,90	1,00	1,10
1,00	63	72	79	89	98	106	113
1,20	71	78	89	99	109	117	128
1,40	76	87	99	110	122	133	141
1,60	84	97	109	118	133	144	159
1,80	90	104	116	131	144	160	171
2,00	98	112	127	141	156	171	187
2,20	102	118	137	152	168	186	202
2,40	110	128	144	163	181	198	216
2,60	116	136	155	173	192	213	231
2,80	124	143	164	185	206	225	247
3,00	130	152	173	194	216	239	261

Medidas en m.



Panel deslizante

Soltis Horizon 86 • Hispa • Anae • Stella

Precio € ud							
Alto	Ancho						
	0,50	0,60	0,70	0,80	0,90	1,00	1,10
1,00	71	79	90	99	110	118	129
1,20	78	90	101	113	124	136	148
1,40	86	99	113	127	138	152	166
1,60	95	109	123	138	153	168	182
1,80	102	118	136	152	168	185	200
2,00	112	129	147	163	182	200	217
2,20	118	138	159	177	198	216	237
2,40	128	148	169	191	212	232	254
2,60	136	156	179	204	227	250	273
2,80	143	168	192	216	240	266	290
3,00	150	179	205	229	254	282	307

Soltis Lounge 92 • Soltis Proof W96 • Screen Elarus

Precio € ud							
Alto	Ancho						
	0,50	0,60	0,70	0,80	0,90	1,00	1,10
1,00	78	90	101	113	124	137	148
1,20	89	101	115	129	141	155	169
1,40	98	114	129	144	160	176	191
1,60	109	124	141	160	177	194	213
1,80	117	137	155	176	194	215	235
2,00	128	150	171	191	213	235	255
2,20	137	161	185	207	230	254	277
2,40	148	173	198	224	248	274	299
2,60	156	185	212	238	266	293	321
2,80	167	197	225	254	283	313	343
3,00	176	207	238	269	301	332	365

Brasilia • Jávea • Screen Nimbus • Screen Kore Cosmos Perla • Hidra • Hiperion Black-Out

Precio € ud							
Alto	Ancho						
	0,50	0,60	0,70	0,80	0,90	1,00	1,10
1,00	63	72	79	89	98	106	113
1,20	71	78	89	99	109	117	128
1,40	76	87	99	110	122	133	141
1,60	84	97	109	118	133	144	159
1,80	90	104	116	131	144	160	171
2,00	98	112	127	141	156	171	187
2,20	102	118	137	152	168	186	202
2,40	110	128	144	163	181	198	216
2,60	116	136	155	173	192	213	231
2,80	124	143	164	185	206	225	247
3,00	130	152	173	194	216	239	261

Sati-Lino

Precio € ud							
Alto	Ancho						
	0,50	0,60	0,70	0,80	0,90	1,00	1,10
1,00	66	75	83	93	101	112	118
1,20	74	83	93	104	115	124	136
1,40	79	92	102	116	128	139	151
1,60	89	100	114	128	140	153	167
1,80	95	110	123	139	153	168	182
2,00	101	117	135	151	167	182	198
2,20	110	127	143	162	179	197	214
2,40	116	136	153	174	192	212	230
2,60	123	143	163	186	206	225	245
2,80	130	152	174	197	217	239	262
3,00	138	161	185	209	231	254	277

Darktex Black-Out

Precio € ud							
Alto	Ancho						
	0,50	0,60	0,70	0,80	0,90	1,00	1,10
1,00	63	72	79	89	98	106	113
1,20	71	78	89	99	109	117	128
1,40	76	87	99	110	122	133	141
1,60	84	97	109	118	133	144	159
1,80	90	104	116	131	144	160	171
2,00	98	112	127	141	156	171	187
2,20	102	118	137	152	168	186	202
2,40	110	128	144	163	181	198	216
2,60	116	136	155	173	192	213	231
2,80	124	143	164	185	206	225	247
3,00	130	152	173	194	216	239	261

Incremento • Accesorios

		Precio € ud
030066	Varilla tirador	38,00
-	Terminal slim	10,00
030620	Tirador imán	20,00
034048	Escuadra separación de 10 cm <i>Blanco, gris, negro, marrón, marfil</i>	5,00
034049	Escuadra separación de 14 cm <i>Blanco, gris, negro, marrón, marfil</i>	5,50
034052	Escuadra separación de 21 cm <i>Blanco, gris, negro</i>	6,00
	Incremento doble mando <i>401, 402, 403, 404, 501, 502, 503, 504</i>	63,00

Incremento • Impresión Digital

Tejidos impresión digital (mínimo 1,50 m², sólo para lama 250)
Sobre el precio Sax 3000, Sax Screen 3600 1% 5% y Black-Out

Precio € m²
65,00



Panel deslizante

Vías y paneles

Riel 2 vías

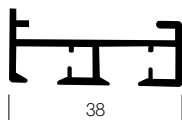

Riel 3 vías

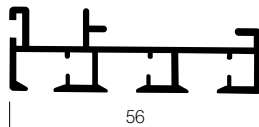

Riel 4 vías

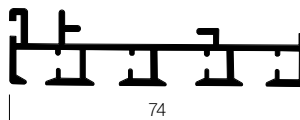

Riel 5 vías

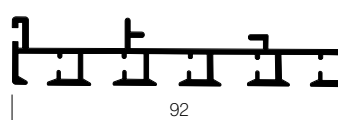

No admite perfil embellecedor.

201



202



301



302



401



402



501



502



203



204



303



304



403



404



503



504



205



206



305



306



405



406



505



506



207



208



307



407



408



507



209



308



409



508



210



410



509



411



510



■ Paneles fijos.

◄ Paneles móviles.

• Motorización y automatismos, **ver tarifa de Motores y Automatismos.**

• Tipologías que no se pueden motorizar: 201, 203, 206, 207, 302, 304, 402, 404, 405.

• Tipologías que se pueden proveer con doble mando: 401, 402, 403, 404, 501, 502, 503, 504.



Panel deslizante

Cálculo de presupuestos

Para sacar el precio del Panel deslizante se divide el ancho total por el número de paneles que se desea pedir.

Ejemplo: Para un Panel deslizante de 3 m. de ancho y un riel de 4 vías con 4 paneles, se divide 3 m. entre 4 paneles dando como resultado 0,75 cm; por lo que, la medida del panel para realizar el presupuesto sería de 0,80 cm.

Soporte • Cantidad de soportes en la instalación

Soportes	Metros						
	0	1	2	3	4	5	6
	2	3	4	5	6	7	8

Soporte 2-3 vías



Soporte 4-5 vías



Riel sistema básico • Perfil embellecedor incluido en el precio

Precio € ud

	Vías	Ancho										
		1,00	1,50	2,00	2,50	3,00	3,50	4,00	4,50	5,00	5,50	6,00
030571	2	54	62	74	85	97	108	118	130	141	152	162
030572	3	59	72	87	101	116	131	145	160	174	187	202
030573	4	71	87	105	121	137	154	170	186	202	220	236
030574	5	83	101	121	138	158	176	195	213	230	250	269

Accesorios y perfil embellecedor en blanco, si quieres otra combinación indícalo en el pedido.

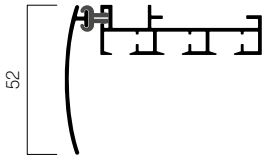

Colores • Sistema básico

Disponible en blanco y plata

Plisada

Haz clic o escanea
para acceder a la ficha
de prescripción





Plisada 20 mm y 25 mm

029001 • 029030

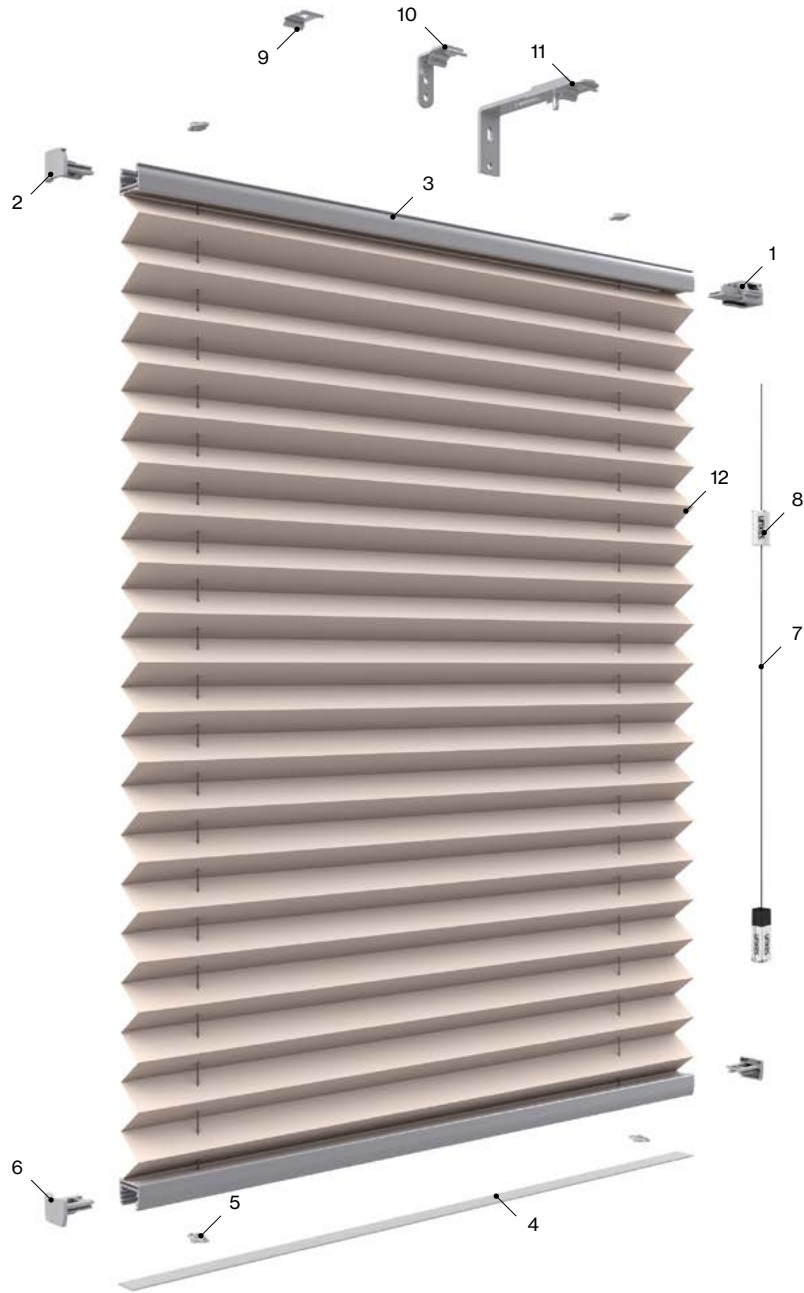

Componentes

Nº	Cód.	Descripción	Nº	Cód.	Descripción
1	029210	Mecanismo Plisada	7	029205	Cordón Plisada 1:2
2	029206	Tapón perfil superior	8	040021	Igualador Plisada
3	029217	Perfil aluminio	9	029202	Soporte techo Plisada sistema cordón
4	029216	Perfil PVC	10	029226	Escuadra soporte pared Plisada
5	029215	Pasa cordón	11	029227	Escuadra separación Plisada
6	029209	Tapón perfil inferior	12	029203	Cordón Plisada 0,8

Medidas de fabricación

Máximos		Mínimos	
Ancho	2,30 m	Ancho	0,30 m
Alto	3,00 m	Alto	0,30 m



Plisada 20 mm

029001

Basic • Basic Perla

		Precio € ud								
		Ancho								
Alto		0,60	0,80	1,00	1,20	1,40	1,60	1,80	2,00	2,20
1,00		98	113	128	141	156	170	185	200	214
1,20		102	118	135	150	166	182	198	214	229
1,40		107	124	141	159	176	193	210	228	245
1,60		110	129	148	167	185	204	222	242	260
1,80		115	135	155	175	194	215	235	255	275
2,00		118	140	162	183	205	225	247	269	290
2,20		123	146	169	191	214	237	260	283	305
2,40		128	152	176	200	224	248	273	297	321
2,60		131	156	183	208	233	259	284	311	336
2,80		136	162	190	216	243	270	297	324	351
3,00		139	168	197	224	253	281	309	338	366

Beautiful

		Precio € ud								
		Ancho								
Alto		0,60	0,80	1,00	1,20	1,40	1,60	1,80	2,00	2,20
1,00		118	140	162	183	205	225	247	269	290
1,20		128	152	176	200	224	248	273	297	321
1,40		136	162	190	216	243	270	297	324	351
1,60		144	174	204	232	262	292	322	352	381
1,80		152	184	217	250	282	314	346	380	412
2,00		160	196	231	266	301	336	371	407	442
2,20		169	207	245	283	321	359	397	435	473
2,40		177	217	259	299	339	381	421	462	503
2,60		185	229	273	315	359	403	446	490	532
2,80		193	239	286	332	378	424	470	518	564
3,00		201	251	300	348	398	446	496	545	593

Black-Out

		Precio € ud								
		Ancho								
Alto		0,60	0,80	1,00	1,20	1,40	1,60	1,80	2,00	2,20
1,00		132	159	185	210	237	262	289	315	340
1,20		144	174	204	232	262	292	322	352	381
1,40		155	189	222	255	289	322	355	389	422
1,60		166	202	240	277	314	351	388	426	462
1,80		177	217	259	299	339	381	421	462	503
2,00		187	232	277	321	366	409	454	499	543
2,20		199	247	296	343	391	439	488	536	583
2,40		210	262	314	366	417	469	521	573	624
2,60		221	276	332	388	443	498	553	610	665
2,80		232	291	351	409	468	528	587	646	705
3,00		243	306	369	431	495	557	620	683	745

Milán

		Precio € ud								
		Ancho								
Alto		0,60	0,80	1,00	1,20	1,40	1,60	1,80	2,00	2,20
1,00		112	131	151	169	189	207	227	246	265
1,20		118	140	162	183	205	225	247	269	290
1,40		125	150	174	197	221	244	268	292	315
1,60		132	159	185	210	237	262	289	315	340
1,80		139	168	197	224	253	281	309	338	366
2,00		146	177	208	238	269	299	330	361	391
2,20		153	186	220	252	285	317	351	384	416
2,40		160	196	231	266	301	336	371	407	442
2,60		167	205	243	279	317	354	392	430	467
2,80		174	214	254	293	334	373	413	453	492
3,00		181	223	266	307	350	391	434	476	518

Palma Basic

		Precio € ud								
		Ancho								
Alto		0,60	0,80	1,00	1,20	1,40	1,60	1,80	2,00	2,20
1,00		150	182	214	245	277	308	340	373	404
1,20		164	201	238	274	311	347	384	421	457
1,40		179	221	262	304	345	386	428	469	511
1,60		193	239	286	332	378	424	470	518	564
1,80		208	259	311	361	412	463	514	566	616
2,00		222	278	335	390	446	501	558	614	669

Palma Black-Out

		Precio € ud								
		Ancho								
Alto		0,60	0,80	1,00	1,20	1,40	1,60	1,80	2,00	2,20
1,00		163	200	237	273	309	345	382	419	454
1,20		181	223	266	307	350	391	434	476	518
1,40		198	246	294	342	390	437	485	534	581
1,60		215	269	323	376	430	483	537	591	644
1,80		232	292	352	411	470	529	589	649	707
2,00		250	315	381	445	511	575	641	706	771

Medidas en m.

Plisada 25 mm

029030

Palma Basic

Alto	Precio € ud									
	0,50	0,70	0,90	1,10	Ancho		1,70	1,90	2,10	2,30
1,00	109	129	151	171	192	214	235	255	276	298
1,20	115	138	162	186	210	235	256	282	305	329
1,40	122	148	175	200	228	254	279	307	332	361
1,60	129	156	187	215	245	275	304	332	362	391
1,80	136	167	199	230	263	294	327	359	390	422
2,00	141	176	212	245	279	315	350	384	419	453
2,20	150	186	224	260	298	336	371	409	446	484
2,40	155	194	236	275	315	355	394	437	476	516
2,60	162	205	248	290	332	376	419	462	504	546
2,80	169	214	260	305	351	397	442	488	532	578
3,00	176	224	273	320	368	417	465	514	560	610

Atlanta Basic FR

Alto	Precio € ud									
	0,50	0,70	0,90	1,10	1,30	1,50	1,70	1,90	2,10	2,30
1,00	136	167	199	230	263	294	327	359	390	422
1,20	148	185	220	256	293	331	368	405	442	478
1,40	160	200	243	285	327	368	408	451	492	535
1,60	173	217	265	312	357	405	451	497	544	591
1,80	185	236	288	339	390	442	492	544	596	646
2,00	197	252	308	365	421	478	534	591	645	703
2,20	209	269	330	391	452	515	576	636	697	758
2,40	220	286	352	419	484	551	616	682	749	814
2,60	232	304	374	445	516	587	658	729	799	871
2,80	245	321	397	472	547	623	699	775	851	927
3,00	256	337	419	498	580	660	741	821	902	983

Colores

Disponible en blanco, negro (9011 mate) y plata

Incremento • Sistema Plisada

	Precio € ud
030275 Varilla de accionamiento 1,50	60,00
029248 Soporte superior para cortina cristal <i>Blanco, gris y negro</i>	0,98
029249 Jgo, soporte inferior cortina cristal <i>Blanco, gris y negro</i>	1,90

Datos del tejido

Código	Tejido (mínimo a facturar 1 ml)	Ancho tejido (ml)	Precio metroraje €
029096	Basic 20	2,35	33,00
029091	Beautiful 20	2,35	60,00
029097	Black-Out 20	2,35	86,00
029105	Basic Perla 20	2,35	40,00
029106	Milán 20	2,35	51,00
029098	Palma Basic 20	3,00	74,00
029099	Palma Black-Out 20	3,00	107,00
029100	Palma Basic 25	3,00	86,00
029101	Palma Black-Out 25	3,00	104,00
029102	Atlanta Basic FR 25	3,05	138,00
029103	Atlanta Black-Out FR 25	3,05	207,00

Palma Black-Out

Alto	Precio € ud									
	0,50	0,70	0,90	1,10	Ancho		1,70	1,90	2,10	2,30
1,00	129	156	187	215	245	275	304	332	362	391
1,20	139	173	206	239	274	307	340	374	407	442
1,40	151	189	227	265	302	340	378	415	453	491
1,60	161	204	245	288	329	371	414	457	498	541
1,80	173	217	265	312	357	405	451	497	544	591
2,00	182	232	285	334	386	438	488	539	589	641
2,20	193	248	304	359	414	469	523	580	635	691
2,40	205	265	324	383	443	503	561	621	681	741
2,60	215	278	343	406	469	535	598	661	726	789
2,80	227	293	362	430	498	567	635	703	772	838
3,00	237	308	382	453	527	599	672	745	817	889

Atlanta Black-Out FR

Alto	Precio € ud									
	0,50	0,70	0,90	1,10	1,30	1,50	1,70	1,90	2,10	2,30
1,00	173	219	266	313	359	406	453	500	546	593
1,20	192	247	301	355	409	466	520	574	630	683
1,40	212	274	336	400	462	523	585	649	712	774
1,60	231	302	371	443	514	583	654	723	795	865
1,80	251	329	407	484	564	642	720	798	875	953
2,00	270	355	443	528	615	700	787	873	959	1.045
2,20	290	383	478	572	666	759	852	948	1.041	1.136
2,40	311	412	514	615	716	819	921	1.022	1.124	1.225
2,60	329	439	547	658	768	876	987	1.097	1.205	1.316
2,80	350	466	583	700	819	936	1.052	1.172	1.289	1.406
3,00	368	495	619	745	869	995	1.121	1.244	1.371	1.495

Medidas en m.

Incremento • Lacado de perfiles

	Plata y lac. RAL	Anodizado	Lac. madera
Perfil Plisada	16,00	25,00	29,00
Guías Glass	8,00	17,00	21,00

* Incrementos por mínimo lacados y anodizados, ver página 11.



Plisada Glass 20 mm

029300

Configuración 111 y 140

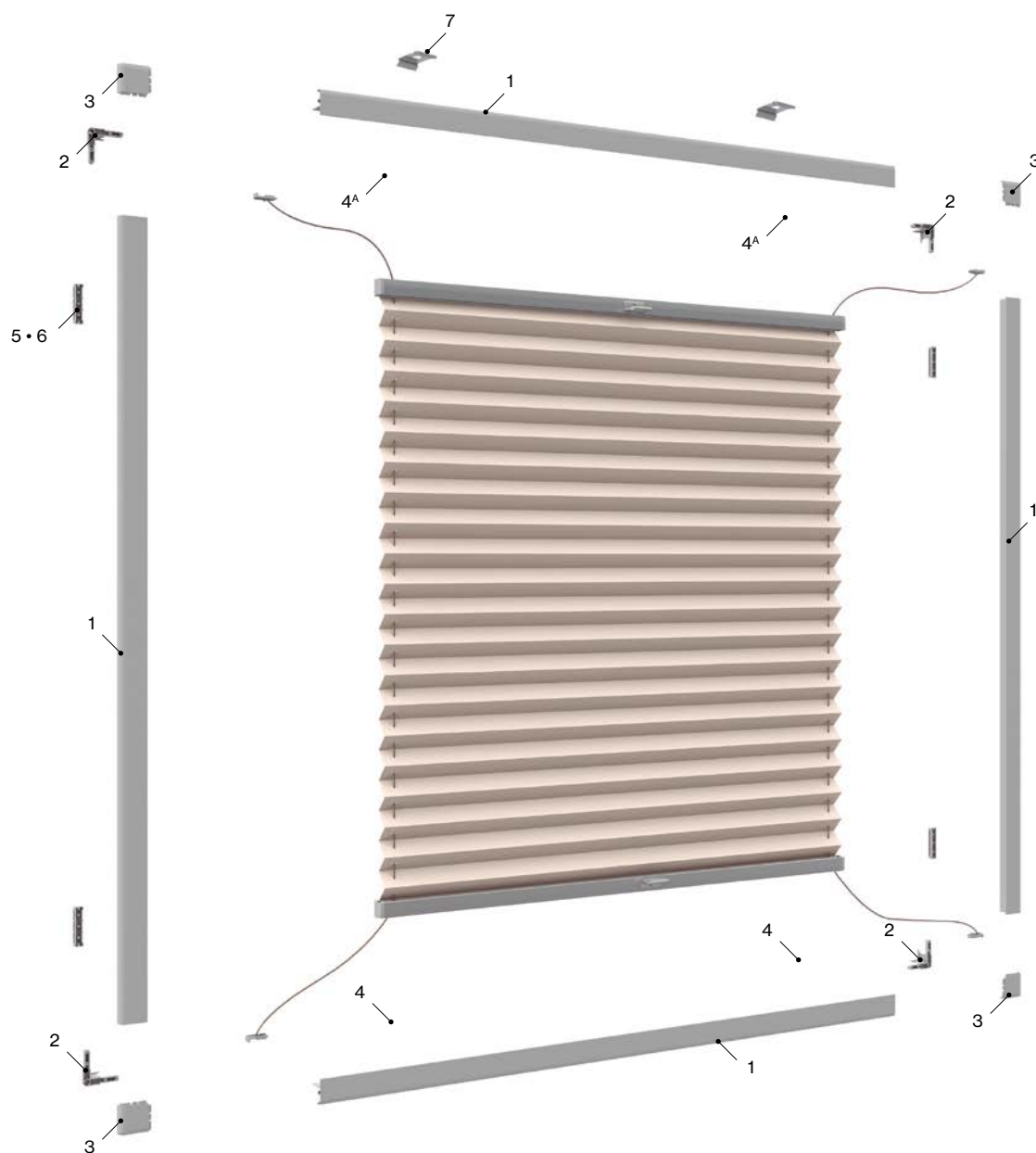

Componentes

Nº	Cód.	Descripción	Nº	Cód.	Descripción
1	031241	Perfil fácil ajuste 580 cm XS	4 ^A	031244	Tension shoe XS (configuración 140)
2	031242	Unión esquina XS	5	031251	Clip sujeción ventana XS
3	031243	Cubierta esquina white ABS XS	6	031253	Cinta sujeción ventana XS
4	031244	Tension shoe XS	7	029202	Soporte techo Plisada sistema cordón

Medidas de fabricación

Máximos		Mínimos	
Ancho	1,20 m	Ancho	0,30 m
Alto	2,40 m	Alto	0,30 m



Plisada Glass 20 mm

029300

Basic • Basic Perla

Alto	Precio € ud			
	Ancho			
	0,60	0,80	1,00	1,20
1,00	138	153	168	182
1,20	143	159	175	190
1,40	147	164	182	199
1,60	151	169	189	207
1,80	155	175	196	215
2,00	159	181	202	223
2,20	163	186	209	231
2,40	168	192	216	240

Beautiful

Alto	Precio € ud			
	Ancho			
	0,60	0,80	1,00	1,20
1,00	159	181	202	223
1,20	168	192	216	240
1,40	176	202	230	256
1,60	184	214	244	273
1,80	192	224	258	290
2,00	200	236	271	306
2,20	209	247	285	323
2,40	217	258	299	339

Black-Out

Alto	Precio € ud			
	Ancho			
	0,60	0,80	1,00	1,20
1,00	173	199	225	251
1,20	184	214	244	273
1,40	196	229	262	296
1,60	206	243	281	317
1,80	217	258	299	339
2,00	228	273	317	361
2,20	239	288	336	383
2,40	251	302	354	406

Milán

Alto	Precio € ud			
	Ancho			
	0,60	0,80	1,00	1,20
1,00	145	162	179	196
1,20	151	169	189	207
1,40	156	177	198	217
1,60	162	184	207	229
1,80	168	192	216	240
2,00	173	199	225	251
2,20	178	206	235	262
2,40	184	214	244	273

Palma Basic

Alto	Precio € ud			
	Ancho			
	0,60	0,80	1,00	1,20
1,00	164	187	210	233
1,20	174	200	227	252
1,40	183	213	242	271
1,60	192	224	258	290
1,80	201	237	273	308
2,00	210	250	289	327

Palma Black-Out

Alto	Precio € ud			
	Ancho			
	0,60	0,80	1,00	1,20
1,00	193	227	260	292
1,20	209	247	285	323
1,40	224	267	311	353
1,60	239	288	336	383
1,80	254	307	361	414
2,00	269	328	386	444

Medidas en m.

Dimensiones del junquillo

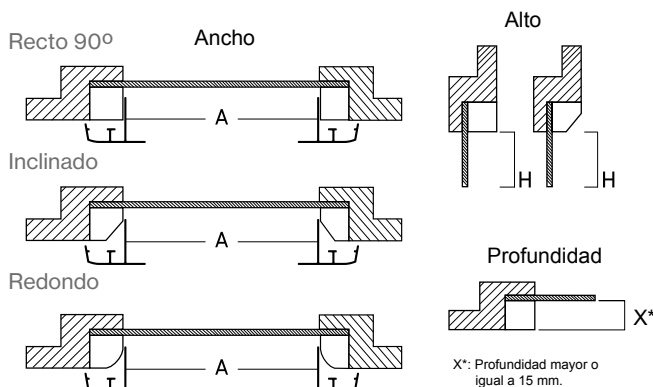

Versión

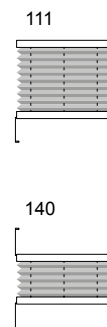

Perfil guía

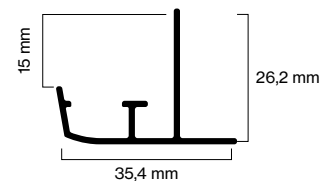



Plisada 20 y 25 mm

Soportes

Soporte techo
029202



Soporte pared
029226



Escuadra separador
029227



Soporte para cortina de cristal



Soporte superior
029248



Jgo. soporte inferior
029249



Tapa soporte
029250

• Colores disponibles en blanco, gris y negro.

Configuraciones

Mecanismo a cordón.
Con guías laterales (cordón).

101

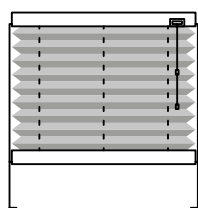

24,00

Mecanismo doble
cordón.
Noche/día.

119

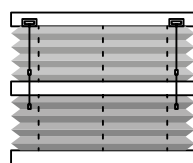

Dos cortinas + 46,00 €

Accionamiento manual.
Con guías laterales
(cordón).

111

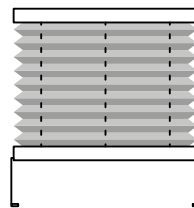

31,00

Accionamiento manual.
Cierre arriba/abajo y abajo/arriba.
Perfil de montaje superior.

112

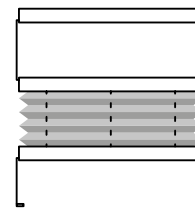

46,00

Precio € ud

Accionamiento manual.
Noche/día.

113

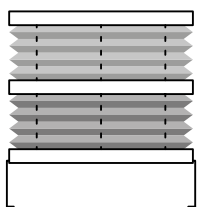

Dos cortinas + 47,00 €

Accionamiento manual.
Con perfil de montaje inferior.

115

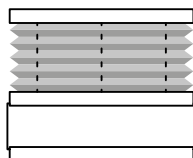

46,00

Accionamiento manual.
Noche/día con apertura
central.

116

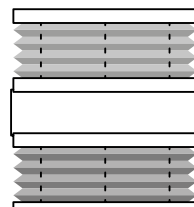

Dos cortinas + 47,00

Accionamiento manual.
Cierre arriba/abajo
y abajo/arriba. Perfil de
montaje superior e inferior.

117

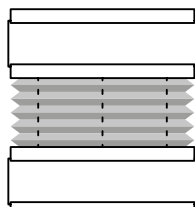

58,00

Precio € ud

Accionamiento manual.
Noche/día con perfil
de montaje inferior.

118

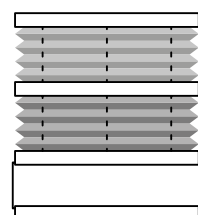

Dos cortinas + 47,00 €

Accionamiento manual.
Apertura central.

120

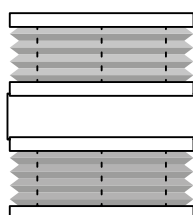

Cortina dividida + 47,00 €

Accionamiento ma-nual.
Cierre arriba/abajo y
abajo/arriba.

140

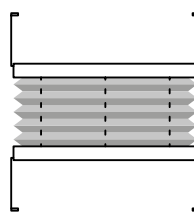

44,00

Precio € ud

• Máximo 1,20 ml de anchura en las versiones 111, 112, 113, 115, 116, 117, 118, 119, 120 y 140.



Plisada 27 Especial

029040

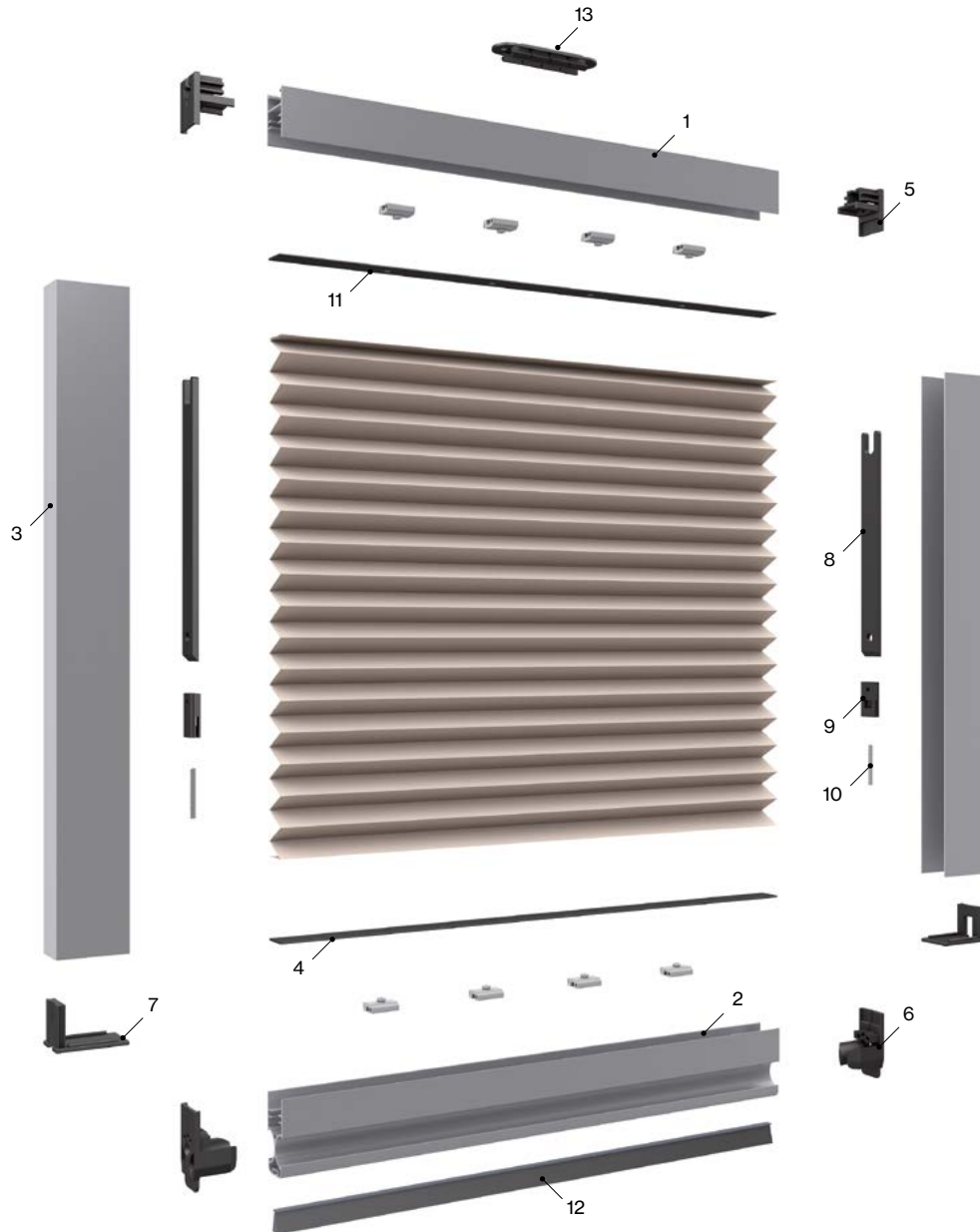

Componentes

Nº	Cód.	Descripción	Nº	Cód.	Descripción
1	042098	Perfil fijo 27	8	042126	Tope testero c/tornillo Vertical 27
2	042096	Perfil móvil 27	9	042113	Sujeción hilo con tuerca remachable 27
3	042099	Guía superior 27	10	042127	Muelle 27
4	042082	Tira PVC anclaje red H260	11	042084	Clip central 27
5	042124	Testero superior perfil fijo 27	12	042805	Felpudo 58-900
6	042125	Testero superior perfil pared	13	042023	Soporte mosquitera Plisada
7	042123	Tapón inferior Vertical 27			

Medidas de fabricación

Máximos		Mínimos	
Ancho	1,60 m	Ancho	0,40 m
Alto	2,60 m	Alto	0,40 m



Plisada 27 Especial

029040

Basic

		Precio € ud						
		Ancho						
Alto		0,40	0,60	0,80	1,00	1,20	1,40	1,60
1,00		136	152	168	185	201	217	235
1,20		137	155	174	191	209	227	245
1,40		139	159	178	198	216	236	254
1,60		141	162	182	205	225	245	266
1,80		144	167	189	210	231	253	275
2,00		148	171	193	216	239	263	286
2,20		151	175	199	224	248	273	296
2,40		153	178	205	230	254	279	306
2,60		155	182	209	236	263	290	316

Black-Out

		Precio € ud						
		Ancho						
Alto		0,40	0,60	0,80	1,00	1,20	1,40	1,60
1,00		160	190	217	248	276	306	334
1,20		168	200	232	267	299	331	365
1,40		175	212	248	286	323	359	394
1,60		182	224	265	305	344	384	426
1,80		190	235	278	324	367	412	457
2,00		198	247	293	343	390	439	485
2,20		206	256	308	362	413	465	516
2,40		213	268	324	381	437	491	546
2,60		220	279	340	400	458	518	577

Milán

		Precio € ud						
		Ancho						
Alto		0,40	0,60	0,80	1,00	1,20	1,40	1,60
1,00		150	174	197	220	244	268	291
1,20		154	181	207	235	260	288	313
1,40		160	190	217	248	276	306	334
1,60		166	198	229	262	292	325	355
1,80		171	206	239	275	308	344	378
2,00		176	214	251	289	325	363	400
2,20		181	222	262	302	342	382	421
2,40		187	230	273	315	357	401	443
2,60		192	238	283	329	374	420	465

Palma Black-Out

		Precio € ud						
		Ancho						
Alto		0,40	0,60	0,80	1,00	1,20	1,40	1,60
1,00		219	278	337	397	455	515	573
1,20		238	307	376	445	514	582	652
1,40		258	337	415	495	572	650	729
1,60		277	366	453	543	631	719	807
1,80		298	394	492	592	690	787	884
2,00		316	426	532	641	748	856	963

Medidas en m.

Perfiles

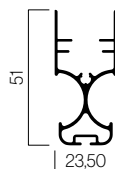
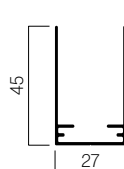
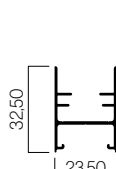
Perfil móvil 27
042096Guía superior 27
042099Perfil fijo 27
042098

Beautiful

		Precio € ud						
		Ancho						
Alto		0,40	0,60	0,80	1,00	1,20	1,40	1,60
1,00		150	174	197	220	244	268	291
1,20		154	181	207	235	260	288	313
1,40		160	190	217	248	276	306	334
1,60		166	198	229	262	292	325	355
1,80		171	206	239	275	308	344	378
2,00		176	214	251	289	325	363	400
2,20		181	222	262	302	342	382	421
2,40		187	230	273	315	357	401	443
2,60		192	238	283	329	374	420	465

Basic-Perla

		Precio € ud						
		Ancho						
Alto		0,40	0,60	0,80	1,00	1,20	1,40	1,60
1,00		138	156	175	193	212	230	248
1,20		140	161	181	201	220	240	262
1,40		144	167	189	210	230	252	274
1,60		148	171	193	217	240	265	288
1,80		152	176	200	227	251	275	299
2,00		154	181	207	235	260	288	313
2,20		156	186	214	243	269	298	327
2,40		161	191	220	251	278	308	339
2,60		163	194	227	258	290	321	352

Palma Basic

		Precio € ud						
		Ancho						
Alto		0,40	0,60	0,80	1,00	1,20	1,40	1,60
1,00		181	222	262	302	342	382	421
1,20		193	239	286	331	376	422	468
1,40		206	256	308	362	413	465	516
1,60		216	275	332	391	447	506	565
1,80		229	292	355	421	484	547	612
2,00		240	312	381	451	520	591	659

Incremento • Sistema Plisada

		Precio € ud
042089	Varilla Plisada 27 de 30 cm	46,00
031325	Varilla de accionamiento 1,50	60,00

Incremento • Lacado de perfiles

	Plata y lacado RAL	Anodizado	Lacado madera
Perfil superior y tirador	21,00	39,00	48,00
Guía	21,00	39,00	48,00

• Precios para blanco.

• Mínimo a facturar 1 ml.

Colores

Disponible en blanco, negro (9011 mate), golden lacado y nogal lacado

• Precios para blanco.

• A efectos de precio se redondeará a la inmediata superior.

Plegable y Pacchetto

Haz clic o escanea para acceder a la ficha de prescripción





Plegable y Pacchetto

038042 • 038061

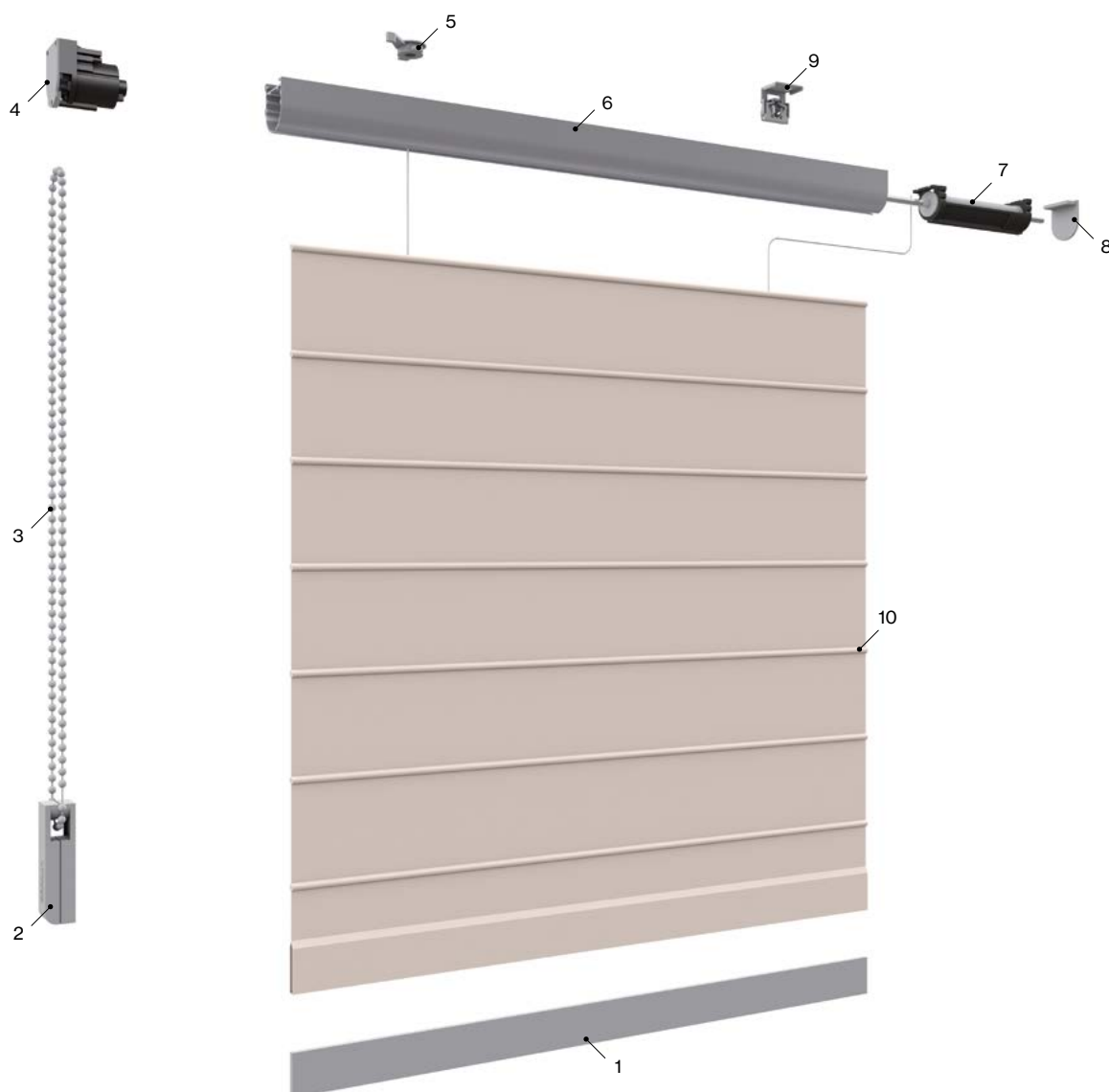

Componentes

Nº	Cód.	Descripción	Nº	Cód.	Descripción
1	030329	Pletina fibra de vidrio	6	028031	Cabezal aluminio
2	030425	Tensor slim L	7	028035	Recogedor cordón plus
3	040083	Aro de cadena 1,50	8	028034	Tapadera plus
4	028033	Comando Plus	9	030291	Soporte techo/pared plus
5	030242	Soporte techo	10	038109	Varilla fibra de vidrio

Medidas de fabricación

Máximos		Mínimos	
Ancho	2,50 m	Ancho	0,40 m
Alto	3,00 m	Alto	0,50 m



Plegable y Pacchetto

038042 • 038061

Mimo • Sati-Lino

Alto	Precio € ud										
	Ancho										
	0,60	0,80	1,00	1,20	1,40	1,60	1,80	2,00	2,20	2,40	2,60
1,00	136	151	167	182	199	215	231	248	263	278	294
1,20	140	159	176	193	212	230	248	266	283	301	317
1,40	147	166	186	205	225	244	265	283	304	323	342
1,60	152	174	194	215	237	258	279	301	323	344	366
1,80	156	179	204	228	251	274	296	320	343	366	389
2,00	163	189	213	238	263	288	313	337	362	388	412
2,20	169	194	222	250	275	302	329	354	382	408	434
2,40	175	204	231	260	289	316	345	374	403	430	458
2,60	179	210	240	270	301	330	362	391	421	451	482
2,80	186	217	250	282	314	345	378	408	442	472	505
3,00	192	225	258	292	327	361	393	428	460	495	528

Tejido Cliente

Alto	Precio € ud										
	Ancho										
	0,60	0,80	1,00	1,20	1,40	1,60	1,80	2,00	2,20	2,40	2,60
1,00	93	109	122	137	152	167	181	197	212	225	239
1,20	98	114	130	147	162	178	194	212	228	244	260
1,40	102	121	138	155	174	191	209	227	244	262	278
1,60	108	128	147	166	185	204	222	240	262	279	299
1,80	113	133	153	175	194	215	236	256	277	298	317
2,00	116	139	161	185	206	228	251	273	293	316	339
2,20	122	144	169	192	216	239	265	288	312	334	357
2,40	128	152	177	201	228	252	277	302	328	352	378
2,60	131	159	185	212	238	265	291	317	344	370	399
2,80	137	163	192	220	250	276	305	332	362	389	417
3,00	140	171	200	230	260	289	317	348	378	407	438

Sin Tejido

Alto	Precio € ud										
	Ancho										
	0,60	0,80	1,00	1,20	1,40	1,60	1,80	2,00	2,20	2,40	2,60
1,00	107	125	140	158	175	192	208	227	244	259	275
1,20	113	131	150	169	186	205	223	244	262	281	299
1,40	117	139	159	178	200	220	240	261	281	301	320
1,60	124	147	169	191	213	235	255	276	301	321	344
1,80	130	153	176	201	223	247	271	294	319	343	365
2,00	133	160	185	213	237	262	289	314	337	363	390
2,20	140	166	194	221	248	275	305	331	359	384	411
2,40	147	175	204	231	262	290	319	347	377	405	435
2,60	151	183	213	244	274	305	335	365	396	426	459
2,80	158	187	221	253	288	317	351	382	416	447	480
3,00	161	197	230	265	299	332	365	400	435	468	504

• Precios para metraje.

• Distancia estándar entre varillas 18 cm.



Plegable y Pacchetto

Modelos

Plegable

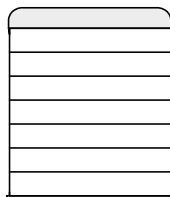

Con varillas horizontales y terminal de aluminio.
Estándar

Pacchetto

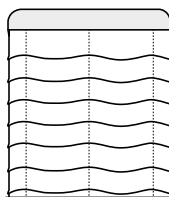

Sin varillas, con cintas verticales y terminal de aluminio.

Perfiles

Sistema plus

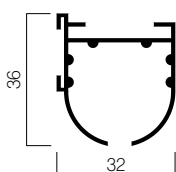

Datos del Tejido

Código	Tejido	Ancho rollo (ml)	Precio metraje €/m ²
031064	Mimo	2,80	35,00
031056	Sati-Lino	2,80	35,00

Incremento • Accesorios

	Precio € ud
034048 Escuadra separación de 10 cm <i>Blanco, gris, negro, marrón y marfil</i>	5,00
034049 Escuadra separación de 14 cm <i>Blanco, gris, negro, marrón y marfil</i>	5,50
034052 Escuadra separación de 21 cm <i>Blanco, gris y negro</i>	6,00

Fantasia

Haz clic o escanea
para acceder a la ficha
de prescripción

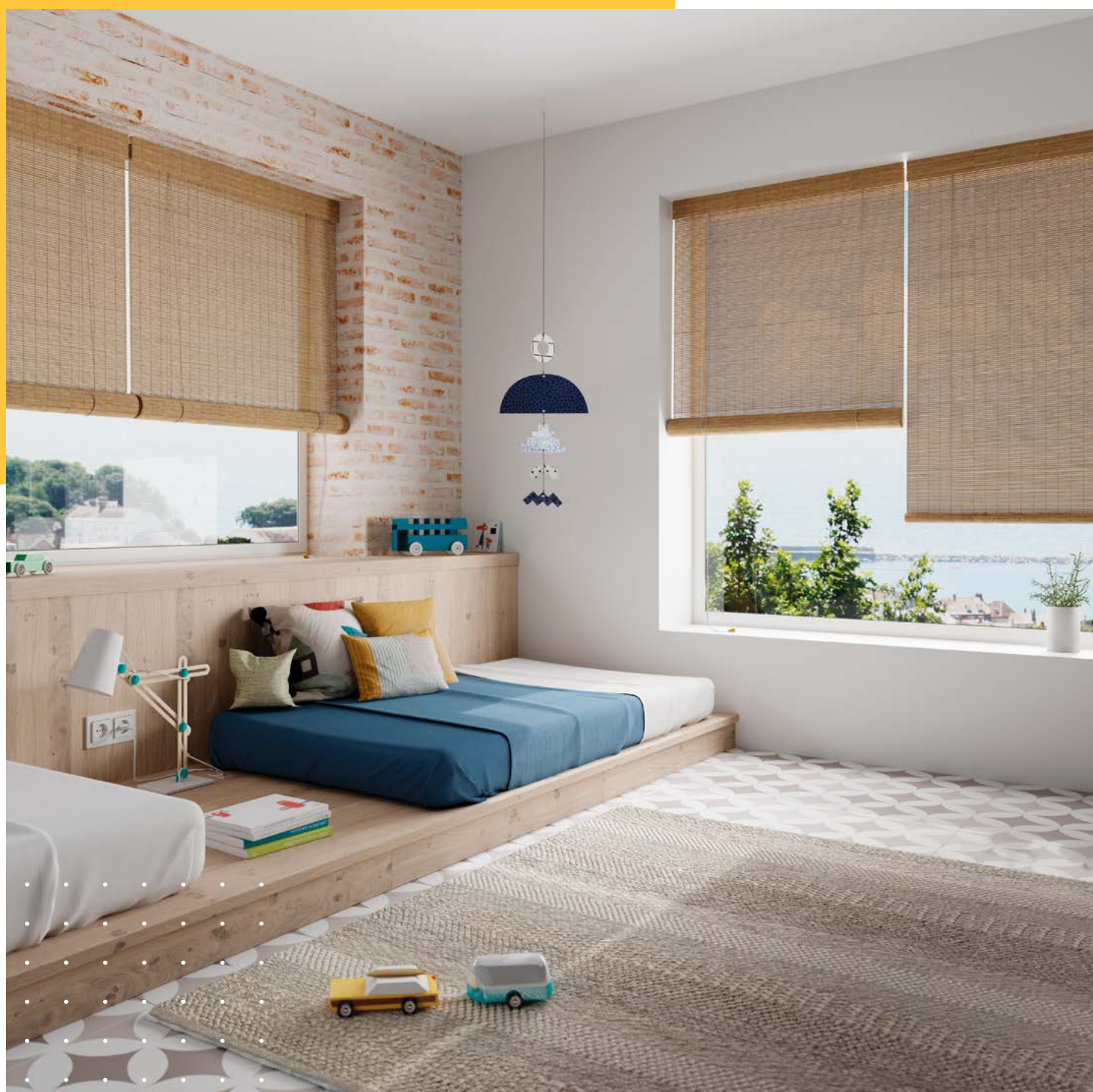



Fantasía

028101

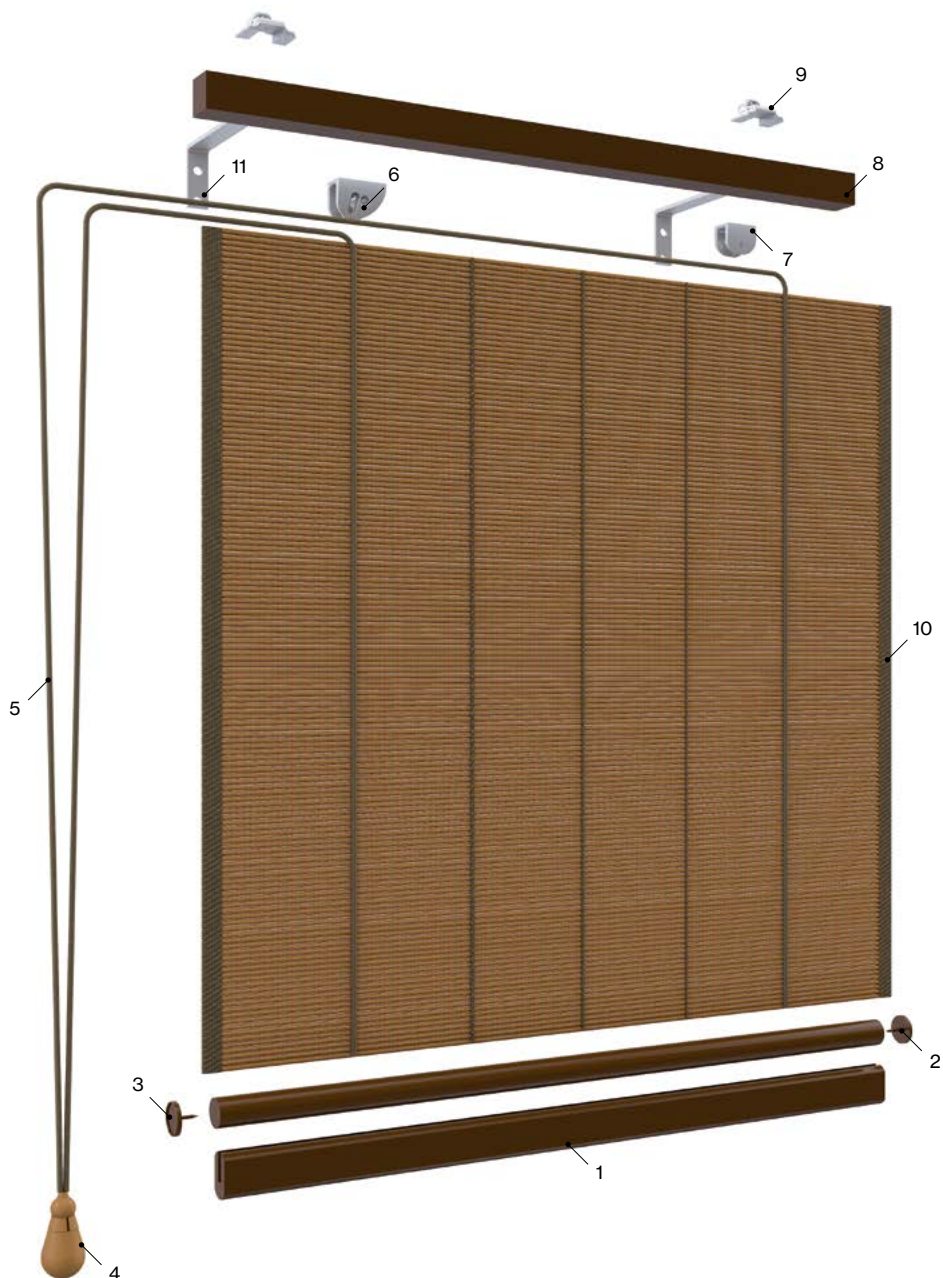

Componentes

Nº	Cód.	Descripción	Nº	Cód.	Descripción
1	028022	Terminal plano	7	028026	Polea
2	028021	Terminal redondo	8	028020	Montante
3	028038	Tapón terminal redondo	9	028134	Soporte techo-pared
4	028027	Bellota	10	028029	Ribete
5	004229	Cordón 2,8	11	028135	Escuadras de separación (10 cm)
6	028025	Freno			

Medidas de fabricación

Máximos		Mínimos	
Ancho	Según tejido	Ancho	0,20 m
Alto	2,00 m	Alto	0,20 m



Precio € ud

Alto	Ancho										
	0,80	0,90	1,00	1,10	1,20	1,30	1,40	1,50	1,60	1,70	1,80
0,80	77	83	89	95	100	108	113	118	125	130	138
1,00	86	93	101	109	115	123	130	138	144	152	161
1,20	98	106	114	123	130	139	148	155	164	173	181
1,40	108	116	127	137	147	155	166	176	185	193	204
1,60	116	128	139	151	162	171	182	193	205	216	225
1,80	128	140	152	164	176	189	200	212	224	237	248
2,00	138	152	164	178	191	205	217	231	244	258	269
2,20	150	163	177	192	206	220	236	250	263	278	292
2,40	159	175	191	206	222	237	252	268	283	300	315
2,60	169	186	204	220	237	253	269	288	304	320	337
2,80	179	198	216	235	252	268	288	305	323	342	359
3,00	190	209	228	248	266	286	305	324	343	362	381

20

21 • 22 • 23

Precio € ud

Alto	Ancho						
	0,80	0,90	1,00	1,10	1,20	1,30	1,40
0,80	84	91	98	105	112	118	125
1,00	95	102	112	121	128	137	144
1,20	108	116	127	137	147	155	166
1,40	121	130	141	153	164	176	186
1,60	130	143	155	168	181	194	207
1,80	143	156	171	185	199	213	227
2,00	155	171	186	202	217	232	248
2,20	167	184	200	217	236	252	268
2,40	179	198	216	235	252	269	289
2,60	192	212	231	251	269	290	308
2,80	204	224	245	267	289	308	330
3,00	216	238	261	282	305	328	350

Precio € ud

Alto	Ancho						
	0,80	0,90	1,00	1,10	1,20	1,30	1,40
0,80	93	101	110	118	127	136	143
1,00	109	118	128	138	148	159	168
1,20	123	136	147	156	169	181	193
1,40	138	151	164	178	191	205	219
1,60	152	167	182	198	213	228	244
1,80	167	184	200	217	235	251	268
2,00	181	200	219	237	255	275	292
2,20	197	216	237	258	277	298	317
2,40	210	232	254	277	300	321	343
2,60	225	250	274	296	320	344	367
2,80	239	266	291	316	343	367	392
3,00	254	281	308	337	363	391	417

Sistemas

Sistema enrollable

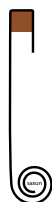

Sistema plegable



Accesorios

Escuadra
028135

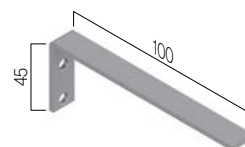

Incremento • Sistema Fantasia

	Precio € ud
Fantasia plegada	35,00
Fantasia plegada (Sistema plus a cadena). Solo tejido 1, 2, 3, 41 y 44	40,00
Fantasia con cortes	22,00
Fantasia con formas	44,00
Escuadra de seraparación 10 cm	10,00

Datos del Tejido

Código	Tejido	Ancho rollo (ml)	Color ribete	Precio € m ²
031015	Tejido 1	1,80	Crudo	54,00
031031	Tejido 2	1,80	Crudo	54,00
031032	Tejido 3	1,80	Kaki	54,00
031019	Tejido 20	1,40	-	58,00
031051	Tejido 21	1,40	-	61,00
031052	Tejido 22	1,40	-	61,00
031078	Tejido 23	1,40	-	61,00
031016	Tejido 41	1,80	Camel	54,00
031017	Tejido 44	1,80	Camel	54,00



Accesorios Venecianas de aluminio 16 y 25

Sistema a cordón

	Precio €	
040028 Lama Veneciana de aluminio 25 mm	0,48 ml	
040000 Lama Veneciana de aluminio 16 mm	0,42 ml	
040002 Terminal cerrado 25 mm	4,00 ml	
040007 Botón riel	0,13 ud	
040001 Cabezal 25	4,90 ml	
040016 Soporte pared/techo	0,60 ud	
040017 Soporte techo	0,60 ud	
040008 Maquinilla graduar	1,20 ud	
040019 Gancho varilla mando	0,35 ud	
040018 Varilla mando	2,60 ml	
040020 Terminal varilla y cordón	1,20 ud	
040010 Maquinilla elevar	1,65 ud	
040013 Soporte rodete 25	0,42 ud	
040015 Varilla eje media luna	1,10 ud	
040011 Bombo de 25	0,17 ud	
040005 Tapón de cabezal de 25	0,12 ud	
040006 Tapón riel de 25	0,12 ud	
040004 Cordón Veneciana 1,4	0,35 ml	



Accesorios Venecianas de aluminio 16 y 25

Sistema a cordón

	Precio €
040029 Escalerilla 25	0,52 ml
040021 Igualador cordón	0,90 ud
040030 Espaciador 25	0,12 ud
040003 Escalerilla 16	0,29 ud
040014 Espaciador 16	0,12 ud
040022 Conector terminal	0,12 ud



Sistema a motor

	Precio €
502443 Motor LV25-B64	258,00 ud
502733 Stop mecánico AMS25	26,00 ud
501954 Integrated DC RTS Receiver	228,00 ud
501851 Cubierta para cono largo CTS 25	0,58 ud
501785 Cono hexagonal largo CTS 25 6 mm	1,55 ud
502555 Transformador (1 motor)	132,00 ud
501958 Interruptor	32,00 ud
040033 Soporte entre cristales	1,00 ud





Accesorios Venecianas de madera

Sistema a cordón

	Precio €
004127 Lama Veneciana de madera 50 CLS Classic	8,60 ml
004126 Terminal Veneciana de madera 50 CLS Classic	19,00 ml
004128 Galería Veneciana de madera 50 CLS Classic	18,50 ml
004135 Cabezal Veneciana de madera 50 CLS	14,50 ml
004138 Cinta de 50 ancho 38 CLS	7,00 ml
004139 Cordón 1,7 mm CLS	0,40 ml
004143 Tirador de aluminio Veneciana 50	4,30 ud
004151 Freno cuerdas Veneciana 50 CLS	8,60 ud
004149 Regulador Veneciana 50 CLS	11,00 ud
004137 Escalerilla cordón de 50 CLS	0,80 ml
004130 Tapón cabezal 50 CLS	0,80 ud
004152 Soporte bombo Veneciana 50 CLS	2,00 ud
004154 Soporte cabezal techo pared CLS	2,60 ud
004179 Placa fijación	4,00 ud



Sistema a motor

	Precio €
004313 Soporte contera y motor Veneciana de madera	7,50 ud
004309 Contera eje 42 octogonal	10,00 ud
004312 Bancada motor Veneciana de madera	10,20 ud
004310 Cono motor lama 50 mm	8,40 ud
004196 Tubo octogonal aluminio	12,00 ml





Accesorios Estor enrollable

Sistema a Cadena

	Precio €
030372 Terminal aluminio slim	10,00 ml
030424 Tapón terminal slim	0,90 ud
034024 Cadena 4,5x6 PVC	0,95 ml
030425 Tensor slim L	2,65 ud
030949 Tapa lateral soporte Estor enrollable S CLS	1,30 ud
030808 Tapa lateral soporte Estor enrollable M CLS	1,40 ud
030846 Tapa lateral soporte Estor enrollable L CLS	2,10 ud
030950 Tapa plástico tornillos soporte Estor enrollable S CLS	1,05 ud
030809 Tapa plástico tornillos soporte Estor enrollable M CLS	1,15 ud
030847 Tapa plástico tornillos soporte Estor enrollable L CLS	1,70 ud
030948 Soporte metal Estor enrollable S CLS	1,90 ud
030807 Soporte metal Estor enrollable M CLS	4,00 ud
030845 Soporte metal Estor enrollable L CLS	4,50 ud
030918 Mecanismo Estor enrollable 1:1 S CLS	7,60 ud
030803 Mecanismo Estor enrollable 1:1 M CLS	14,60 ud
030844 Mecanismo Estor enrollable 1:3 L CLS desmultiplicador	31,60 ud
030823 Adaptador tubo 43 CLS	0,80 ud
030867 Adaptador tubo 65 mm	9,00 ud





Accesorios Estor enrollable

Sistema a Cadena

	Precio €
030919 Cápsula eje 35 CLS	0,75 ud
030806 Cápsula eje 43 CLS	1,55 ud
030801 Tope opuesto soporte metal Enrollable CLS	1,10 ud
030920 Tubo de aluminio 35	13,25 ml
031330 Tubo de aluminio 44	14,40 ml
030773 Tubo de aluminio 65	22,50 ml
024552 Tubo aluminio 80	21,00 ml
030551 Tope bola cadena	0,22 ud
034037 Unión a cadena	0,30 ud



Sistema a Cardán

	Precio €
030372 Terminal aluminio Slim	10,00 ml
030424 Tapón terminal Slim	0,90 ud
030198 Manivela cardán	40,00 ud
030199 Manivela con gancho 1,80 (cardán-eje 78)	23,00 ud
030808 Tapa lateral soporte Enrollable M CLS	1,40 ud
030846 Tapa lateral soporte Enrollable L CLS	2,10 ud
030809 Tapa plástico tornillos soporte Enrollable L CLS	1,15 ud
030847 Tapa plástico tornillos soporte Enrollable L CLS	1,70 ud
030807 Soporte metal Enrollabale M CLS	4,00 ud





Accesorios Estor enrollable

Sistema a Cardán

	Precio €
030845 Soporte metal Enrollable L CLS	4,50 ud
030902 Sujeción motor eje 43 CLS	5,20 ud
030934 Placa unión cardán-soporte CLS	8,20 ud
030190 Cardán eje 43	50,00 ud
030176 Cardán eje 60	67,00 ud
030193 Cardán eje 78	75,00 ud
030561 Cápsula perno cuadrado cardán eje 43	5,10 ud
030562 Cápsula perno cuadrado cardán eje 50/60	5,10 ud
030563 Cápsula perno cuadrado cardán eje 78	11,40 ud
030823 Adaptador eje 43 CLS	0,80 ud
030806 Cápsula eje 43 CLS	1,55 ud
030536 Adaptador eje 50/60	7,30 ud
030538 Cápsula motor/cardán eje 78	6,80 ud
030801 Tope opuesto soporte metal Enrollable CLS	1,10 ud
030569 Perno soporte cápsula eje 78	15,50 ud
031330 Tubo aluminio 44	14,40 ml
030506 Tubo aluminio 60	21,00 ml





Accesorios Estor enrollable

Sistema Saxun Box 70 y 90 interior

	Precio €	
030372 Terminal de aluminio slim	10,00 ml	
030424 Tapón terminal slim	0,90 ud	
034024 Cadena 4,5x6 PVC	0,95 ml	
030425 Tensor slim L	2,65 ud	
030885 Tapa lateral cajón cuadrado S derecho	2,20 ud	
030883 Tapa lateral cajón redondo S derecho	1,80 ud	
030831 Tapa lateral cajón cuadrado M derecho	2,50 ud	
030830 Tapa lateral cajón redondo M derecho	2,45 ud	
030876 Juego de soportes metal cajón Enrollable S	3,60 jgo	
030822 Juego de soportes metal cajón Enrollable M	5,00 jgo	
030803 Mecanismo Enrollable 1:1 M CLS	14,60 ud	
030823 Adaptador tubo 43 CLS	0,80 ud	
030806 Cápsula eje 43 CLS	1,55 ud	
030801 Tope opuesto soporte metal Enrollable CLS	1,10 ud	
031330 Tubo aluminio 44	14,40 ml	
030879 Tapa cajón S cuadrado	27,00 ml	
030826 Tapa cajón M cuadrado	38,00 ml	
030880 Tapa cajón S redondo	27,00 ml	



Accesorios Estor enrollable

Sistema Saxun Box 70 y 90 interior

	Precio €
030827 Tapa cajón M redondo	33,35 ml
030877 Perfil base cajón S	24,30 ml
030824 Perfil base cajón M	35,00 ml
030821 Soporte instalación cajón M	4,00 ud
030551 Tope bola cadena	0,22 ud
034037 Unión a cadena	0,30 ud
030875 Soporte instalación S	2,50 ud



Sistema Saxun Box 110 interior y exterior

	Precio €
030182 Terminal contrapeso sistema 110	17,50 ml
030320 Tapón terminal contrapeso sistema 110	3,60 ud
030216 Juego embellecedor testero Saxun Box 110 redondo	15,00 ud
030722 Juego embellecedor testero S. Box 110 cuadrado	25,00 jgo
030547 Juego testero metálico Saxun Box 110 redondo	28,00 jgo
030721 Juego testero metálico Saxun Bos 110 cuadrado	44,00 jgo
030569 Perno soporte cápsula eje 78	15,50 ud
030538 Cápsula motor/cardán eje 78	6,80 ud
022807 Tubo de enrollle 78	14,50 ml





Accesorios Estor enrollable

Sistema Saxun Box 110 interior y exterior

	Precio €
004274 Cajón Saxun Box 110 Perfil tapadera redondo	23,70 ml
030708 Perfil cofre inferior 110 cuadrado	36,60 ml
004275 Cajón Saxun Box 110 Perfil angular redondo	51,50 ml
030854 Perfil base cajón L cuadrado	51,50 ml
030540 Soporte techo Saxun Box 110	4,00 ud
030542 Soporte pared Saxun Box 110	14,50 ud
022489 Juego soporte pared/techo cajón 110 cuadrado	21,20 ud



Sistema Rafter M y L

	Precio €
031201 Juego tapadera PVC soporte Rafter L	11,40 jgo
030998 Soporte metálico Rafter L	17,80 ud
030999 Adaptador soporte Rafter L	5,50 ud
031203 Perfil Rafter aluminio L	48,00 ml
030844 Mecanismo enrollable 1:3 L CLS desmultiplicador	31,60 ud
030867 Adaptador tubo 65 mm	9,00 ud
030773 Tubo de aluminio 65 mm	22,50 ml
030806 Cápsula eje de 43 CLS	1,55 ud
030801 Tope opuesto soporte metal CLS	1,10 ud





Accesorios Estor enrollable

Sistema Rafter M y L

	Precio €
030995 Juego tapadera PVC soporte Rafter M	7,00 jgo
030992 Soporte metálico Rafter M	6,30 ud
030997 Perfil Rafter aluminio M	32,00 ml
031330 Tubo de aluminio 44 mm	14,40 ml
030803 Mecanismo enrollable 1:1 M CLS	14,60 ud
030996 Guiado mecanismo Rafter M	1,40 ud



Sistema Rafter doble cortina

	Precio €
031201 Juego tapadera PVC soporte Rafter L	11,40 jgo
030998 Soporte metálico Rafter L	17,80 ud
030999 Adaptador soporte Rafter L	5,50 ud
031203 Perfil Rafter aluminio L	48,00 ml
030803 Mecanismo enrollable 1:1 M CLS	14,60 ud
031330 Tubo de aluminio 44 mm	14,40 ml
030801 Tope opuesto soporte metal CLS	1,10 ud
030806 Cápsula eje de 43 CLS	1,55 ud
031202 Guiado mecanismo Rafter L	3,20 ud
030996 Guiado mecanismo Rafter M	1,40 ud





Accesorios Vision

Sistema básico CLS

	Precio €
030757 Terminal aluminio redondo Vision CLS	14,00 ml
030758 Tapón plástico terminal redondo Vision CLS	0,80 ud
040083 Aro cadena PVC a 1,50	6,60 ud
030425 Tensor slim L	2,65 ud
030808 Tapa lateral soporte Enrollable M CLS	1,40 ud
030807 Soporte metal Enrollable M CLS	4,00 ud
030895 Soporte barra estabilizadora	1,90 ud
030801 Tope opuesto soporte metal Enrollable CLS	1,10 ud
030919 Cápsula eje 35 mm CLS	0,75 ud
030918 Mecanismo Enrollable 1:1 S CLS	7,60 ud
030920 Tubo aluminio Enrollable CLS 35	13,25 ml
030894 Barra estabilizadora CLS	13,80 ml



Sistema semicajón CLS

	Precio €
030757 Terminal aluminio redondo Vision CLS	14,00 ml
030758 Tapón plástico terminal redondo Vision CLS	0,80 ud
040083 Aro cadena PVC a 1,50	6,60 ud
030425 Tensor slim L	2,65 ud
030881 Juego tapas laterales semicajón 70 M CLS	3,20 jgo





Accesorios Vision

Sistema semicajón CLS

	Precio €
030876 Juego soportes metal cajón 70 CLS	3,60 jgo
030875 Soporte semicajón 70	2,50 ud
030801 Tope opuesto soporte metal Enrollable CLS	1,10 ud
030919 Cápsula eje 35 mm CLS	0,75 ud
030918 Mecanismo Enrollable 1:1 S CLS	7,60 ud
030920 Tubo aluminio Enrollable CLS 35	13,25 ml
030878 Semicajón de 70	25,00 ml



Accesorios Stor Glass

Sistema Intra

	Precio €
030024 Cajón Stor Glass	23,60 ml
030034 Juego testeros	6,20 jgo
030033 Embellecedor	6,20 jgo
030028 Eje 18 mm	8,20 ml
030038 Cápsula	3,70 ud
030025 Guía aluminio 33 mm	5,40 ml
030042 Cadena PVC 3,2x6	1,00 ml
030044 Topes cadena	0,20 ud





Accesorios Stor Glass

Sistema Intra

	Precio €
030045 Unión cadena	0,20 ud
030039 Tapón guía (sólo guía 33 mm)	1,20 jgo
030027 Terminal aluminio	10,40 ml
030041 Tapón terminal	0,23 ud
030031 Goma estanca	2,80 ml
030037 Mecanismo	11,60 ud
030047 Sujeción cadena	0,20 ud
030775 Tensor slim M	2,40 ml
030946 Guía aluminio 50	5,90 ml



Sistema Extra

	Precio €
030024 Cajón Stor Glass	23,60 ml
030034 Juego testeros	6,20 jgo
030033 Embellecedor	6,20 jgo
030028 Eje 18 mm	8,20 ml
030038 Cápsula	3,70 ud
031208 Guía aluminio tipo C	5,40 ml
030042 Cadena PVC 3,2x6	1,00 ml





Accesorios Stor Glass

Sistema Extra

	Precio €
031210 Juego tapón guía tipo C	1,30 jgo
031207 Perfil espaciador	11,40 ml
031209 Juego esquina para espaciador	3,20 jgo
030027 Terminal aluminio	10,40 ml
030041 Tapón terminal	0,23 ud
030031 Goma estanca	2,80 ml
030037 Mecanismo	11,60 ud
030075 Tensor slim M	2,40 ud



Accesorios Cortina horizontal

Sistema a motor

	Precio €
001206 Perfil angular Saxun Box 92	33,40 ml
001207 Perfil tapa Saxun Box 92	15,00 ml
030229 Juego de testero con enlace Saxun Box 92	5,50 ud
030218 Juego de tapas testero Saxun Box 92	2,35 ud
030076 Guía 60x27	24,00 ml
030506 Eje aluminio 60	21,00 ml
030580 Terminal plano contrapeso	17,80 ml

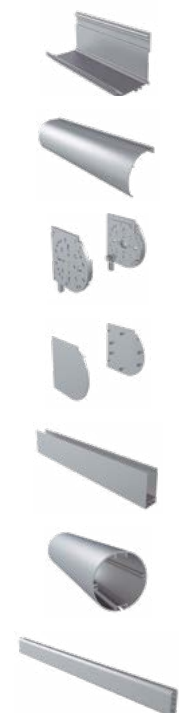



Accesorios Cortina horizontal

Sistema a motor

	Precio €
030404 Contera eje de 50/60	20,64 ud
030312 Tapón terminal plano	0,40 ud
030403 Contera eje de 45	7,10 ud
030501 Eje aluminio 45	11,70 ml
030640 Muelle sistema Veranda 45	42,00 ud
030477 Soporte techo	1,00 ud
030233 Soporte pared	4,80 ud



Accesorios Cortina vertical

Sistema 89 y 127

	Precio €
034267 Riel Vertical redondo CLS	17,60 ml
034222 Soporte riel Vertical	0,60 ud
029159 Eje 3 vías	2,50 ml
034221 Carro 3 vías gancho CLS	0,40 ud
034217 Carro arrastre CLS	0,60 ud
034279 Tapadera lado contrario CLS	0,46 ud
034224 Comando CLS	3,00 ud
030483 Cadena mando 3,8x9 mm	0,90 ml

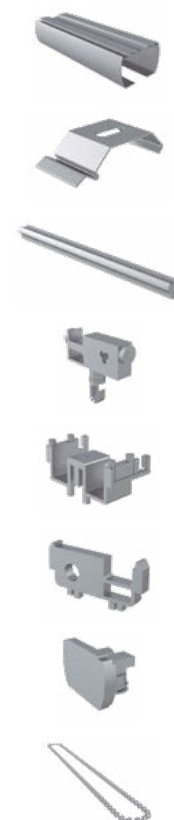



Accesorios Cortina vertical

Sistema 89 y 127

	Precio €
030426 Tensor slim XL	3,60 ud
034022 Cordón	0,30 ml
034045 Percha plástico 89	0,23 ud
034043 Contrapeso de 89	0,51 ud
034047 Cadena distanciadora 89	0,80 ud
034046 Percha plástico 127	0,36 ud
034044 Contrapeso de 127	0,52 ud
034023 Cadena distanciadora 127	0,80 ud
034048 Escuadra 10 cm	5,00 ud
034037 Unión cadena	0,30 ud

Sistema 250

	Precio €
034267 Riel Vertical redondo CLS	17,60 ml
034222 Soporte riel Vertical	0,60 ud
029159 Eje 3 vías	2,50 ml
034221 Carro 3 vías gancho CLS	0,40 ud
034217 Carro arrastre CLS	0,60 ud
034279 Tapadera lado contrario CLS	0,46 ud





Accesorios Cortina vertical

Sistema 250

	Precio €
034224 Comando CLS	3,00 ud
030483 Cadena mando 3,8x9 mm	0,90 ml
030426 Tensor slim XL	3,60 ud
034022 Cordón	0,30 ml
030151 Percha plástico 250	1,20 ud
030153 Contrapeso 250	2,25 ud
034052 Escuadra 21 cm	6,00 ud



Accesorios Panel deslizante

Sistema Básico

	Precio €
030451 Perfil Panel deslizante - 3 vías	19,30 ml
030477 Soporte perfil 2 y 3 vías Panel deslizante	1,00 ud
030478 Soporte perfil 4 y 5 vías Panel deslizante	1,35 ud
030463 Juego cabezal - 3 vías	5,50 ud
030461 Porta telas con velcro	10,70 ml
030472 Soporte enlace perfil galería	0,65 ud
030479 Perfil embellecedor	9,50 ml
030710 Tope en "L"	0,35 ud





Accesorios Panel deslizante

Sistema Básico

	Precio €
030709 Tope con tornillo	0,85 ud
030707 Unión de cordón	0,26 ud
030711 Tope en "T"	0,35 ud
030470 Correderas porta telas	0,50 ud
030473 Cordón	0,50 ml
030426 Tensor slim XL	3,60 ud
030456 Pletina aluminio	6,75 ml
030413 Velcro macho	3,80 ml
030066 Varilla tirador 1 m	38,00 ud



Accesorios Plisada

Sistema 20 mm

	Precio €
029210 Mecanismo Plisada	6,20 ud
029206 Tapón perfil superior	0,75 ud
029217 Perfil aluminio	12,20 ml
029216 Perfil PVC	1,75 ml
029215 Pasa cordón	0,80 ud
029209 Tapón perfil inferior	0,95 ud





Accesorios Plisada

Sistema 20 mm

	Precio €
029205 Cordón Plisada 1:2	0,40 ml
029212 Igualador Plisada	1,35 ud
029202 Soporte techo Plisada sistema cordón	1,35 ud
029226 Escuadra soporte pared Plisada	2,20 ud
029227 Escuadra separación Plisada	5,40 ud
029203 Cordón Plisada 0,8	0,30 ml



Plisada 27 especial

	Precio €
042098 Perfil fijo 27	13,80 ml
042096 Perfil móvil 27	26,50 ml
042099 Guía superior 27	16,80 ml
042082 Tira PVC anclaje red H260	15,20 ml
042124 Testero superior perfil fijo 27	8,90 ud
042125 Testero superior perfil pared	7,60 ud
042123 Tapón inferior Vertical 27	6,40 ud
042126 Tope testero con tornillo Vertical 27	6,90 ud
042113 Sujeción hilo con tuerca remachable 27	6,20 ud
042127 Muelle 27	6,90 ud





Accesorios Plisada

Plisada 27 Especial

	Precio €
042084 Clip central 27	1,55 ud
042805 Felpudo 58-900	0,50 ml
042023 Soporte mosquitera plisada	2,40 ud



Accesorios Plegable y Pacchetto

Sistema a cadena











	Precio €
030329 Pletina fibra de vidrio	10,00 ml
030425 Tensor slim L	2,65 ud
040083 Aro de cadena 1,50	6,60 ud
028033 Comando plus	7,40 ud
030242 Soporte techo	1,00 ud
028031 Cabezal aluminio	28,00 ml
028035 Recogedor cordón plus	5,00 ud
028034 Tapadera plus	0,50 ud
030291 Soporte techo/pared plus	2,70 ud
038109 Varilla fibra de vidrio	0,50 ml





Accesorios Fantasía

Sistema a cordón

	Precio €	
028022 Terminal plano	14,50 ml	
028021 Terminal redondo	3,20 ml	
028038 Tapón terminal redondo	3,00 ud	
028027 Bellota	3,80 ud	
004229 Cordón 2,8	0,70 ml	
028025 Freno	9,10 ud	
028026 Polea	7,30 ud	
028020 Montante	3,80 ml	
028134 Soporte techo-pared	3,50 ud	
028029 Ribete	1,20 ml	
028135 Escuadras de separación (10 cm)	10,00 ud	

saxun
by Giménez Ganga

Giménez Ganga, S.L.U.

Polígono Industrial El Castillo
C/ Roma, 4 • 03630
Sax (Alicante) • España

saxun.com



Tu mundo,
nuestro universo.

